



NSS evo2

Operator Manual

ENGLISH



Preface

Disclaimer

As Navico is continuously improving this product, we retain the right to make changes to the product at any time which may not be reflected in this version of the manual. Please contact your nearest distributor if you require any further assistance.

It is the owner's sole responsibility to install and use the instrument and transducers in a manner that will not cause accidents, personal injury or property damage. The user of this product is solely responsible for observing safe boating practices.

NAVICO HOLDING AS AND ITS SUBSIDIARIES, BRANCHES AND AFFILIATES DISCLAIM ALL LIABILITY FOR ANY USE OF THIS PRODUCT IN A WAY THAT MAY CAUSE ACCIDENTS, DAMAGE OR THAT MAY VIOLATE THE LAW.

Governing Language: This statement, any instruction manuals, user guides and other information relating to the product (Documentation) may be translated to, or has been translated from, another language (Translation). In the event of any conflict between any Translation of the Documentation, the English language version of the Documentation will be the official version of the Documentation.

This manual represents the product as at the time of printing. Navico Holding AS and its subsidiaries, branches and affiliates reserve the right to make changes to specifications without notice.

Trademarks

Lowrance® and Navico® are registered trademarks of Navico.

Fishing Hot Spots® is a registered trademark of Fishing Hot Spots Inc. Copyright© 2012 Fishing Hot Spots.

Navionics® is a registered trademark of Navionics, Inc.

NMEA 2000® is a registered trademark of the National Marine Electronics Association.

Additional mapping data: Copyright© 2012 NSI, Inc.: Copyright© 2012 by Richardson's Maptech.

Copyright

Copyright © 2014 Navico Holding AS.

Warranty

The warranty card is supplied as a separate document.

In case of any queries, refer to the brand website of your display or system:

www.simrad-yachting.com

Regulatory statements

This equipment is intended for use in international waters as well as coastal sea areas administered by countries of the E.U. and E.E.A.

The NSS evo2 complies with:

- CE under R&TTE directive 1999/5/EC
- The requirements of level 2 devices of the Radiocommunications (Electromagnetic Compatibility) standard 2008.

The relevant Declaration of conformity is available in the NSS evo2 section on the following website: www.simrad-yachting.com.

About this manual

This manual is a reference guide for operating the Simrad NSS evo2 systems. It assumes that all equipment is installed and configured, and that the system is ready to use.

The manual assumes that the user has basic knowledge of navigation, nautical terminology and practices.

Important text that requires special attention from the reader is emphasized as follows:

→ **Note:** Used to draw the reader's attention to a comment or some important information.

⚠ **Warning:** Used when it is necessary to warn personnel that they should proceed carefully to prevent risk of injury and/or damage to equipment/personnel.

Viewing the manual on the NSS evo2 screen

The pdf viewer included in the NSS evo2 makes it possible to read the manuals and other pdf files on the unit. Manuals can be downloaded from www.simrad-yachting.com.

The manuals can be read from an inserted Micro-SD card or copied to the unit's internal memory.

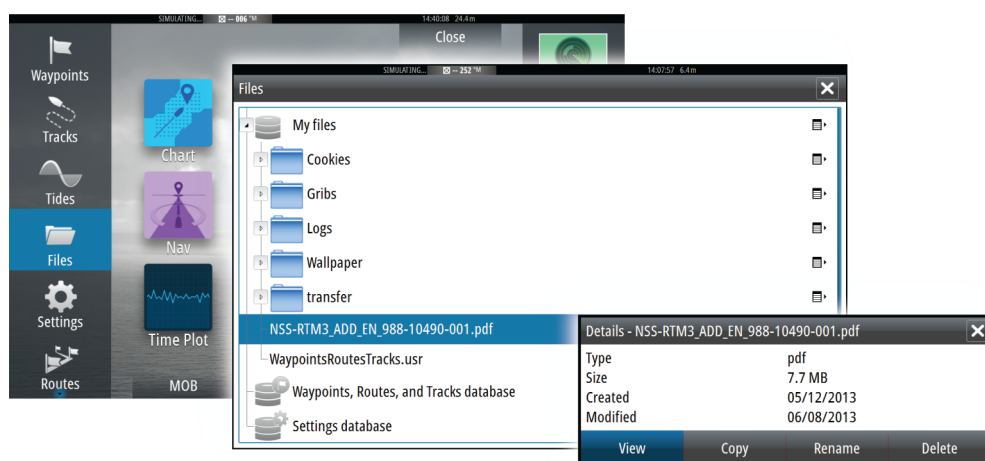

Use the keys and on-screen buttons to maneuver in the pdf file as below:

Search, Goto page, Page Up and Page Down	Tap the relevant button
Scroll pages	Turn the rotary knob
Panning on the page	Drag finger on the screen in any direction
Zoom In/Out	Use pinch or spread gestures
Exit the pdf viewer	Press the X key or the X in the upper right corner of the panel.

The software

This manual is written for the NSS evo2 Release to Market 1 (RTM1).

The manual will be continuously updated to match new software releases. The latest available manual version can be downloaded from www.simrad-yachting.com.

Contents

9	Introduction
9	The front panel and keys
10	The Home page
11	Application pages
12	Integration of 3 rd party devices
13	GoFree™ wireless
13	OP40 Remote controller
14	Basic operation
14	Turning the unit on and off
14	Display illumination
14	Locking the touch screen
15	Touch screen operation
16	Using menus and dialogs
16	Selecting pages and panels
17	Adjusting panel size
17	Adding new favorite pages
17	Edit favorite pages
18	Customizing the Home page background
18	Setting the appearance of the Instrument bar
19	Positioning a Man Over Board mark
19	Screen capture
20	Charts
20	The Chart panel
21	Showing dual chart types
21	Vessel symbol
21	Chart scale
21	Panning the chart
21	Positioning the vessel on the chart panel
22	Displaying information about chart items
22	Using the cursor on the chart panel
23	Saving waypoints
23	Creating routes
23	Measuring distance
23	Find objects on chart panels
24	3D charts
24	Chart overlay
24	Insight specific chart options
25	Insight view options
25	Navionics specific chart options
26	Navionics view options
28	Chart settings
29	Waypoints, routes and tracks
29	Waypoints
30	Routes
31	Tracks
32	Waypoints, routes and tracks dialogs
33	Navigating
33	Navigation panels
34	Navigate to cursor position
34	Navigate a route
35	Navigating with the autopilot
35	Navigation settings

37 Autopilot

- 37 Safe operation with the autopilot
- 37 Activating the autopilot
- 37 Switching from automatic mode to manual steering
- 37 Autopilot indication on the pages
- 38 The Autopilot panel
- 39 Mode overview
- 40 Standby mode
- 40 Non-Follow Up (NFU, Power steering)
- 40 Follow-up steering (FU)
- 40 AUTO mode (auto compass)
- 41 NoDrift mode
- 41 NAV mode
- 42 WIND mode
- 43 WIND Nav mode
- 44 Turn pattern steering
- 45 Using the NSS evo2 in an AP24/AP28 system
- 46 Using the autopilot in an EVC system
- 46 Autopilot settings

49 Radar

- 49 The radar panel
- 49 Radar overlay
- 50 Radar operational modes
- 50 Radar Range
- 50 Using the cursor on a radar panel
- 50 Saving waypoints
- 51 Adjusting the radar image
- 52 Advanced radar options
- 52 Radar view options
- 53 EBL/VRM markers
- 54 Setting a guard zone around your vessel
- 55 MARPA targets
- 56 Recording radar data
- 56 Radar settings

58 Echosounder

- 58 The Echosounder image
- 59 Zooming an Echosounder image
- 59 Using the cursor on the echosounder panel
- 60 Saving waypoints
- 60 Viewing sounder history
- 60 Setting up the Echosounder image
- 61 Advanced Echosounder options
- 61 Recording echosounder data
- 62 Echosounder view options
- 63 Echosounder settings

65 StructureScan™

- 65 The StructureScan™ image
- 65 Zooming the StructureScan image
- 66 Using the cursor on the StructureScan™ panel
- 66 Saving waypoints
- 66 Viewing StructureScan™ history
- 67 Setting up the StructureScan image
- 67 Recording StructureScan data
- 68 Advanced StructureScan settings

69	StructureMap
69	The StructureMap image
69	Activating Structure overlay
69	StructureMap sources
70	StructureMap tips
70	Recording StructureScan data
70	Using StructureMap with mapping cards
71	Structure options
72	AIS
72	AIS target symbols
73	Viewing information about AIS targets
74	AIS SART
75	Vessel alarms
75	Vessel settings
78	Instrument panels
78	Dashboards
78	Customizing the Instrument panel
79	Audio
79	Enabling audio
80	The Audio panel
81	Setting up the audio system
82	Operating the audio system
82	Favourite channels
82	Using Sirius radio (North America only)
83	Weather
83	GRIB weather
84	SiriusXM™ weather
89	Video
89	The Video panel
89	Setting up the video panel
89	FLIR camera control
91	Time plots
91	The Time plot panel
91	Selecting data
92	Alarms
92	Alarm system
92	Type of messages
92	Single alarms
92	Multiple alarms
93	Acknowledging a message
93	Alarms dialog
94	Tools
94	Waypoints/routes/tracks
94	Tides
94	Alarms
94	Settings
94	Vessels
94	Sun/moon
94	Trip calculator

94	Files
94	Find
95	Simulator
95	About the simulator
95	Demo mode
95	Selecting simulator source files
96	Advanced simulator settings
97	Maintenance
97	Preventive maintenance
97	Cleaning the display unit
97	Cleaning the media port door
97	Checking the keys
97	Checking the connectors
97	NMEA 0183 Data logging
98	Software upgrades
98	Backing up your system data

1

Introduction

The front panel and keys

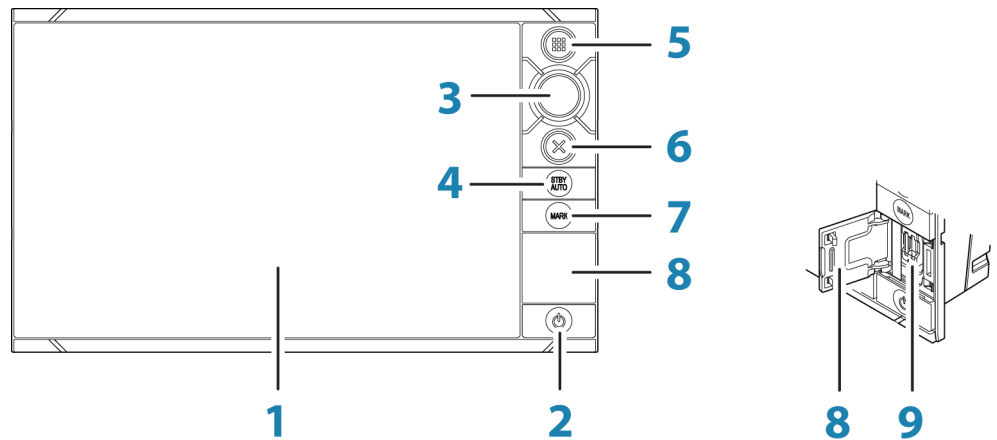

Key	Description
1	Touch screen
2	Power key Press once to display the System control dialog. Repeat short presses to cycle the backlight brightness. Press and hold to turn the unit ON/OFF.
3	Rotary knob Rotate to scroll through menu items, then press to confirm a selection. Rotate to adjust a value. Rotate to zoom a zoomable panel.
4	STBY / AUTO key With the autopilot in any automatic mode: Press to set the autopilot to Standby mode. With the autopilot in Standby mode: Press to display the autopilot mode selection pop-up.
5	Home key Press once to activate the Home page. Repeat short presses to cycle the favorite buttons. Press and hold to display the Favorite panel as an overlay on active page. Repeat short presses to cycle the favorite buttons.
6	X key Press once to exit a dialog, to return to previous menu level and to remove the cursor from the panel.
7	MARK key With cursor active on the panel: Press to immediately save a waypoint at cursor position. With no active cursor: Press to immediately save a waypoint at vessel position. Press and hold to display the Plot menu used for saving new waypoints, routes and tracks.
8	Card reader door
9	Micro-SD Card readers

→ *Note:* The MARK key is not available on 7" units.

The Home page

The Home page is accessed from any operation by a short press on the **Home** key.



Key	Description
1	Applications Tap a button to display the application as a full page panel. Press and hold a button to display pre-configured split page options for the application.
2	Tools Tap a button to access dialogs used for carrying out a task, or for browsing stored information.
3	Close button Tap to exit the Home page and return to the previous active page.
4	Favorites Tap a button to display the panel combination. Press and hold a favorite button to enter edit mode for the Favorites panel.
5	Mand Over Board (MOB) button Tap to save a Man Over Board (MOB) marker at the current vessel position.

Application pages

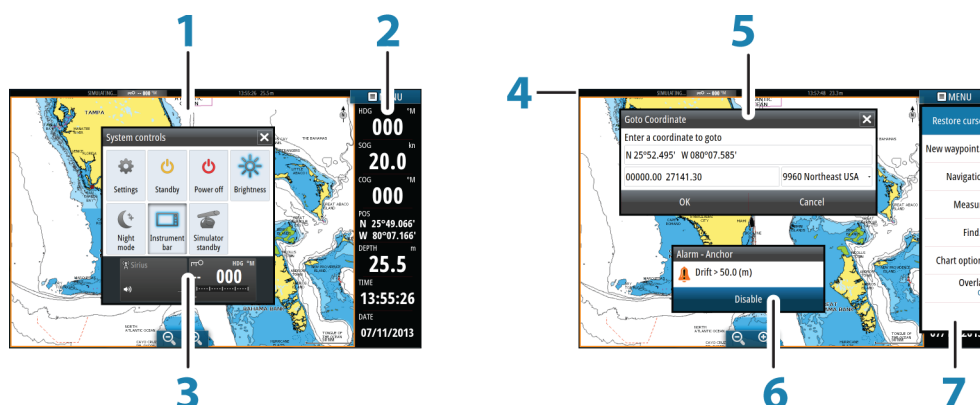

Each application connected to the system is presented on panels. The application can be presented as a full page, or in combination with other panels in a multiple panel page. All pages are accessed from the Home page.

Key	Description
1	Application panel
2	Instrument bar Navigation and sensor information. The bar can be tuned off and it can be configured by the user.
3	System Control dialog Quick access to basic system settings. Display the dialog by a short press on the Power key or by swiping down from top of the screen.
4	Status bar
5	Dialog Information to or input from the user.
6	Alarm message Displayed if dangerous situations or system faults occur.
7	Menu Panel specific menu. Display the menu by tapping the MENU panel button.

Split pages

You can have several panels on one page depending on screen size:

- 7" units: 2 panels
- 9", 12" and 16" units: 4 panels

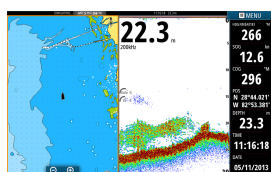

2 panels page

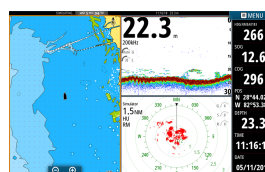

3 panels page

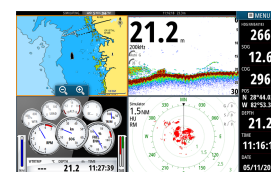

4 panels page

All panel sizes in a split page can be adjusted.

Pre-configured split pages

Each full screen applications have several pre-configured split pages, featuring the selected application combined with each of the other panels.

- **Note:** The number of split pages can not be changed, and the pages can not be customized or deleted.

You access a split page by pressing and holding the main panel button.

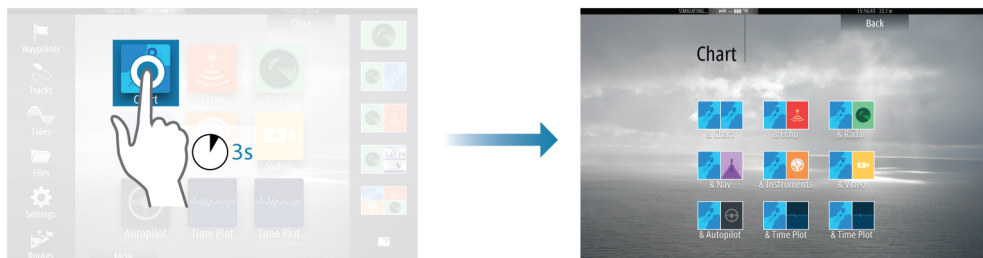

Favourite pages

All preconfigured favourite pages can be modified and deleted, and you can create your own favourite pages. You can have a total of 12 favourite pages.

Integration of 3rd party devices

Several 3rd party devices can be connected to the NSS evo2 system. The applications are displayed on separate panels or integrated with other panels.

A device connected to the NMEA 2000 network should automatically be identified by the NSS evo2. If not, enable the feature from the advanced option in the System settings dialog.

The 3rd party device is operated from the NSS evo2 by using menus and dialogs as on other panels.

This manual does not include specific operation instructions for any 3rd party device. For features and functionality, refer to the documentation included with the 3rd party device.

Mercury VesselView integration



Mercury VesselView 7 SmartCraft data display and interaction are enabled through the NSS evo2 when a VesselView 7 gateway device is present on the NMEA 2000 network.

A Mercury icon will automatically appear on the Home page when the device is available.

FUSION-Link integration

FUSION-Link devices connected to the NMEA 2000 network can be controlled from the NSS evo2.

The FUSION-Link devices will appear as additional sources when using the audio function. No additional icons will be available.

Refer to "**Audio**" on page 79 for more information.

FLIR camera integration

If a FLIR camera is available on the Ethernet network, you can display the video and control the camera from the NSS evo2.

The FLIR camera is controlled from the Video panel, and no additional icons will appear on the Home page.

Refer to "**Video**" on page 89 for more information.



BEP CZone integration

The NSS evo2 system integrate with BEP's CZone system used for controlling and monitoring a distributed power system on your vessel.

The CZone icon will be available in the Tools panel on the Home page when a CZone system is available on the network.

A separate manual is provided with your CZone system. Refer to this documentation and to the NSS evo2 Installation manual for how to install and configure the CZone system.

CZone dashboard

When the CZone is installed and configured, an additional CZone dashboard will be added to the Instrument panels.

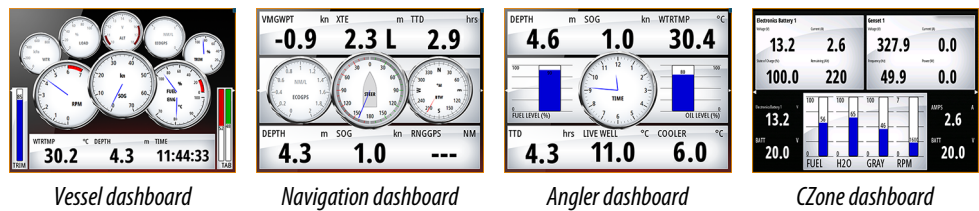

You switch between a panel's dashboards by tapping the left and right arrow symbols or by selecting the dashboard from the menu.

Editing a CZone dashboard

You can customize a CZone dashboard by changing the data for each of the gauges. Available editing options depend on the type of gauge and which data sources that are connected to your system.

For more information refer to the "Instrument panels" on page 78 section.

GoFree™ wireless

With a WIFI-1 unit connected to the NSS evo2 system you can use a wireless device to remotely control the unit. The NSS evo2 is controlled from the wireless device by Apps downloaded from their relevant Application store.

→ **Note:** For security reasons Autopilot and CZone control are currently not supported for control from a wireless device.

Installation and wiring for the WIFI-1 unit are described in the separate WIFI-1 Installation Guide. Configuration and setup are described in the NSS evo2 Installation manual.

Operating the NSS evo2 with a wireless device

When remote control is accepted, the NSS evo2 page will be mirrored to the wireless device.

The NSS evo2 image includes softkeys. Tapping these keys works as operating the similar hard keys on the NSS evo2.

OP40 Remote controller

You can connect an OP40 to the network and remotely control the NSS.

A separate manual is included with the OP40 unit.

2

Basic operation

Turning the unit on and off

You turn the unit on and off by pressing and holding the **Power** key.

If the key is released before the shut-down is completed, the power off process is cancelled.

You can also turn the unit off from the System controls dialog, activated by a short press on the **Power** key.

- **Note:** The System Controls dialog will not display the power off option when the unit is configured as slave. Refer details in the NSS evo2 Installation manual.



First time startup

The first time the unit is started and after a master reset the system will run through an automatic start-up sequence, including language setup and automatic data source selection.

You can select to interrupt this sequence and later configure the system yourself.

Standby mode

In Standby mode the sonar is set to standby, and the backlight for screen and keys are turned off to save power. The system will continue to run in the background.

You select Standby mode from the System Controls dialog.

Switch from Standby mode to normal operation by a short press on the **Power** key.

Display illumination

The display backlighting can be adjusted at any time from the System control dialog.

A night mode which optimizes the color palette for low light conditions, is included.

- **Note:** Details on the chart may be less visible when the Night mode is selected!

Locking the touch screen

You can temporarily lock the touch screen to prevent accidental operation of the system.

This feature is also useful when cleaning the screen while the unit is turned on.

When the touch lock is active you can only operate the units from the keys.

The touch screen operation is locked from the System control dialog.







You remove the lock function by a short press on the **Power** key.



Touch screen operation

Basic touch screen operation on the different panels is shown in the table below.

The panel sections later in this manual have more information about panel specific touch screen operation.

Icon	Description
	Tap to: <ul style="list-style-type: none"> • Activate a panel on a multi-panel display • Position the cursor on a panel • Select a menu and a dialog item • Toggle a checkbox option on or off • Show basic information for a selected item
	Press and hold: <ul style="list-style-type: none"> • On any panel with a cursor to activate the cursor assist feature • On a panel button to see available split screen options • On a favorite button to enter edit mode
	Scroll through a list of available options without activating any option.
	Flick to quickly scroll through e.g. the waypoint list. You need to tap the screen to stop the scrolling.
	Pan to position a chart or an echo image on the panel.
	Pinch to zoom out on the chart or on an image.
	Spread to zoom in on the chart or on an image

Using menus and dialogs

Menus

You display a page menu by tapping the **MENU** button in the upper right corner of the page.

- Select a menu item and toggle on/off a checkbox by tapping it
- Adjust a slide bar value by either:
 - dragging the slide bar
 - tapping the + or - icons

You can also operate the menus by using the rotary knob.

- Turn the knob to scroll through menu items
- Press the knob to select a highlighted item
- Turn the knob to adjust the value of a selected item

Tap the **Back** menu option or the **X** key to return to previous menu level, and then exit.

You can make the menu slide away by tapping the screen outside the menu area. When you re-press the **MENU** button, the menu opens in the same status it had before it closed.

Different menu options are available depending on if the cursor is active or not.



Chart menu - cursor not active

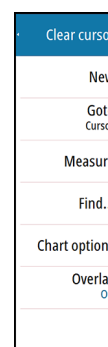

Chart menu - active cursor

Dialog boxes

You select entry fields and keys in a dialog box by tapping the screen or by using the rotary knob.

Numeric and alphanumeric keyboards are automatically displayed when required for entering user information in dialogs. You operate the keyboard by tapping the virtual keys, and you confirm your entry by tapping the **Enter** keyboard key.

A dialog is closed by saving or cancelling the entry.

A dialog can also be closed by tapping the **X** in the dialog's upper right corner or by pressing the **X** key.

Selecting pages and panels

All pages are selected from the Home page.

- Select a full page panel by tapping the relevant application button
- Select a predefined split panel by pressing and holding the relevant application button
- Select a favourite page by tapping the favourite button

Adjusting panel size

You can change the panel size for an active split page. The panel size can be adjusted for both favorite pages and for predefined split pages.

1. Activate the System control dialog by pressing the **Power** key or by dragging your finger from the top of the screen
2. Select the adjust splits option in the dialog
3. Drag the adjustment icon to resize the panel
4. Confirm your changes by tapping on of the panels or by pressing the rotary knob

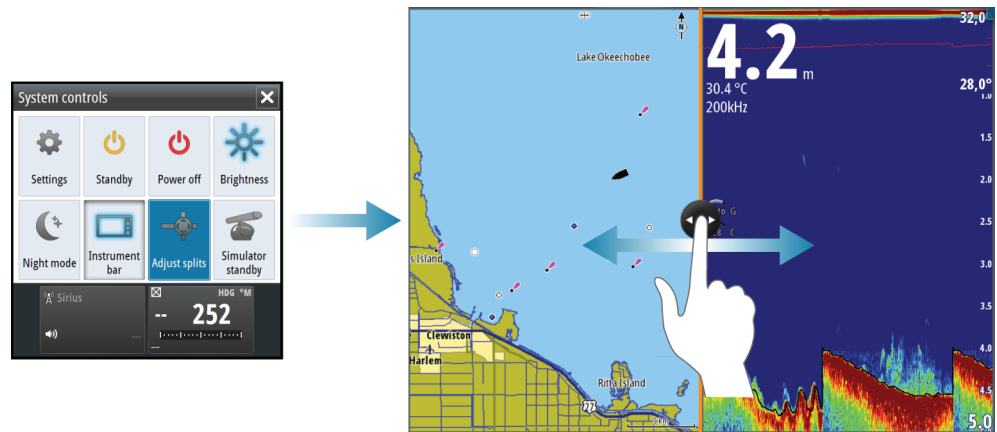

The changes are saved to the the active favorite or split page.

Adding new favorite pages

1. Tap the **New** icon in the favorite panel on the Home page to open the page editor dialog
2. Drag and drop page icons to set up a new page
3. Save the page layout

The display will return to the Home page, and the new page will be included in list of favorite pages.

Edit favorite pages

1. Tap the edit icon or press and hold a favorite icon to enter edit mode
 - Tap the cancel icon to remove a page
 - Tap the tools icon to display the page editor dialog
2. Add or remove panels in the page editor dialog, then save your changes
3. Press the **X** key to leave the favorite edit mode

Customizing the Home page background

The Home page's background can be customized. You can select one of the pictures included with the system, or you can use your own picture in .jpg or .png format.

The images can be available on any location that can be seen in the files browser. When a picture is chosen as the wallpaper, it is automatically copied to the Wallpaper folder.

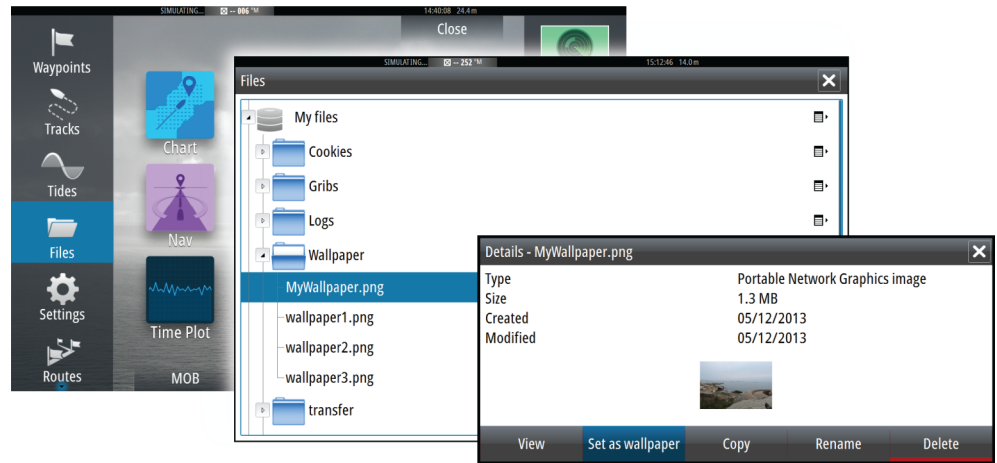

Setting the appearance of the Instrument bar

Data sources connected to the system can be viewed in the Instrument bar.

You can configure the Instrument bar to display either one or two bars, or set it to alternate the bars automatically.

You can turn the Instrument bar off from the System control dialog.

→ **Note:** This only turns the Instrument bar off for the current page.

Turning the Instrument bar on/off

1. Activate the System control dialog by pressing the **Power** key or by dragging your finger from the top of the screen
2. Toggle on/off the instrument bar from the System control dialog.

Edit the content of the Instrument bar

1. Tap the Instrument bar to make it active
 2. Tap the **MENU** button to edit the content
 3. Select the content you want to display
- **Note:** You can configure Bar 1 for active page or for all pages except those that have a local configuration. Bar 2 can only be configured for active page.
4. Define the time period if you want the two bars to alter automatically
 5. Select the edit option to change any of the instrument fields, followed by the field you want to change
 6. Save your changes by selecting the finish edit option in the menu.

Positioning a Man Over Board mark

If an emergency situation should occur, you can position a Man Over Board mark at the vessel's current position by pressing the **Home** key followed by the **MOB** button on the Home page.

When you activate the MOB function the following actions are automatically performed:

- a MOB mark is positioned at the vessel's position
- the display switches to a zoomed chart panel, centered on vessel position
- the system displays navigation information back to the MOB mark

Multiple MOB marks are positioned by repeated presses on the **MOB** button. The vessel will continue to show navigation information to the initial MOB mark. Navigation to subsequent MOB marks will need to be done manually.

Cancel navigation

The system will continue to display navigating towards the MOB mark until you select to cancel the navigation from the menu.

Delete a MOB mark

1. Tap the MOB mark to activate it
2. Tap the MOB mark's pop-up to display the MOB mark dialog
3. Select the delete option in the dialog

A MOB mark can also be deleted from the menu when it is activated. See also the "*Waypoints-Routes-Tracks*" on page 29 section.

Screen capture

Simultaneously press the **Home** and **Power** keys to take a screenshot. By default, screen captures are saved to internal memory.

Refer to the "*Tools*" on page 94 section for how to view and manage files.

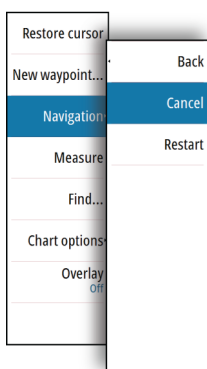

3

Charts

The chart function displays your vessel's position relative to land and other chart objects. On the chart panel you can plan and navigate routes, place waypoints and display AIS targets. You can overlay a radar image, a StructureScan image or weather information.

The NSS evo2 is delivered with different cartography depending on region. All units will support Navionics Platinum Plus, TurboView and C-Map (by Jeppesen) via micro-SD card or via the Ethernet network.

Charts can be shared over the Ethernet network, so only one chart card per boat is required.

The Chart panel

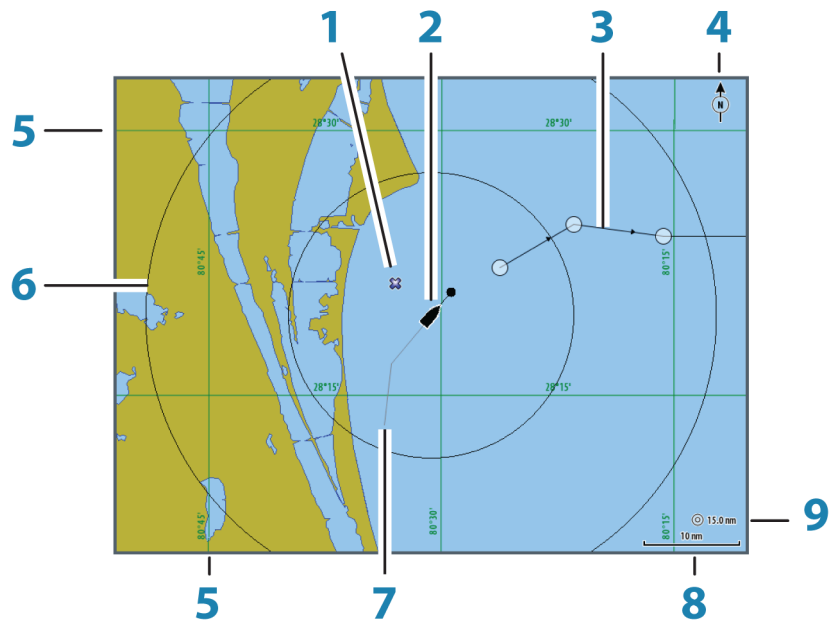

Key	Description	Comment
1	Waypoint	*
2	Vessel with extension line	Extension line is optional
3	Route	*
4	North indicator	
5	Grid	*
6	Range rings	*
7	Track	*
8	Chart range scale	
9	Range rings interval	Only displayed when Range rings are turned on

* Optional chart items

→ **Note:** You turn the optional images on/off individually. For more information, see "*Chart settings*" on page 28.

Showing dual chart types

If you have different chart types available - embedded, in the card slot or on the Ethernet - you can show two different chart types simultaneously on a page with two chart panels.

You can select a dual chart panel by pressing and holding the Chart application button on the Home page, or by creating a Favorite page with two chart panels.

Selecting chart type

Chart type is set individually for each chart panel.

Tap one of the chart panels, and select one of the available chart types from the chart options menu. Repeat the process for the second chart panel, and select an alternative chart type for this panel.

→ **Note:** To show charts from other than Navionics, Insight chart type must be selected.

If you have identical charts available - built in, in the card slot or on the Ethernet network - the system will automatically select the chart with most chart details for your displayed region.

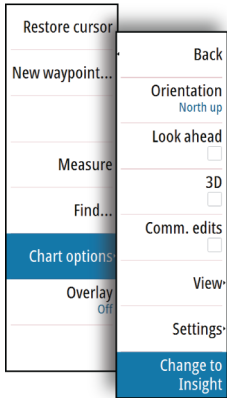

Vessel symbol

When a GPS and a suitable heading sensor are connected to the system, the vessel symbol indicates vessel position and heading.

Without a heading sensor fitted, the vessel icon will orientate itself using COG (Course over Ground). If no GPS is available the vessel symbol will include a question mark.

Chart scale

You zoom in and out on the chart by using the zoom panel icons, the rotary knob, or by using 2 fingers to pinch (zoom out) and spread (zoom in).

Chart range scale and range rings interval (when turned on) will be shown in the lower right corner of the chart panel.



Panning the chart

You can move the chart in any direction by dragging your finger in the desired direction.

Press the **X** key or tap the **Clear cursor** menu option to remove the cursor and cursor window from the panel. This will also center the chart to vessel position.

Positioning the vessel on the chart panel

Chart orientation

Several options are available for how the chart is rotated in the panel. The chart orientation symbol in the panel's upper right corner indicates the north direction.

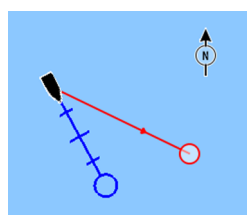

North up

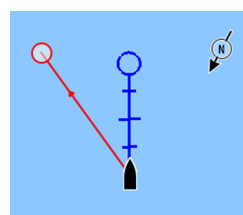

Heading up

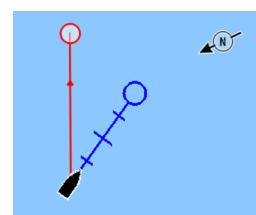

Course up

North up

Displays the chart with the north direction upward. Corresponds to the usual orientation of nautical charts.

Heading up

Displays the chart with the vessel's heading directly up on the chart image. Heading information is received from a compass. If heading is not available, then the COG from the GPS will be used.

Course up

Rotates the chart in the direction of the next waypoint when navigating a route or navigating to a waypoint. If not navigating the heading up orientation will be used until navigation is started.

Look ahead

Centres the chart slightly forward of your vessel so that you can maximize your view ahead.

Displaying information about chart items

When you tap a chart item, a waypoint, a route or a target, basic information for the selected item will be displayed. By tapping a chart item's pop-up, all available information for that item will be shown.

→ *Note:* Pop-up information has to be enabled in chart settings to see basic item information.

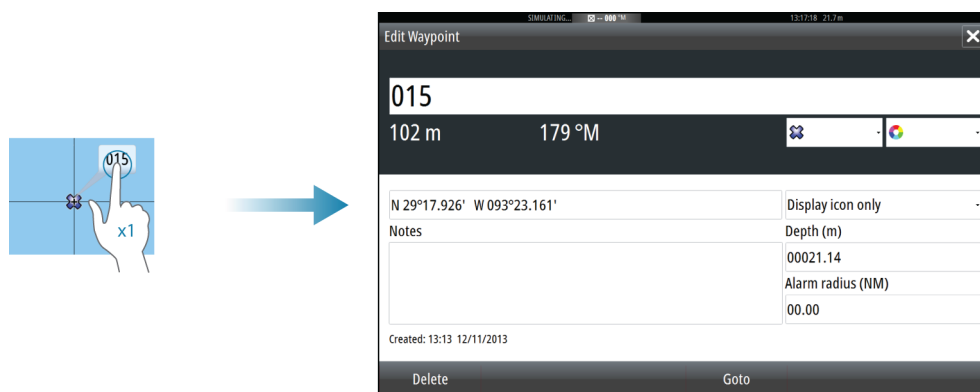

Available information for a selected chart item can also be displayed by using the menu.

Using the cursor on the chart panel

N 26°24.311'
W 79°29.178'
5.0 m, 183 °M

The cursor is by default not shown on the chart panel.

When you tap the screen, the cursor will become visible and the cursor position window will be activated. When the cursor is active, the chart will not pan or rotate to follow the vessel.

Press the **X** key or tap the **Clear cursor** menu option to remove the cursor and cursor window from the panel. This will also center the chart to vessel position.

Tap the **Restore cursor** menu option to display the cursor in its previous location. The **Clear cursor/Restore cursor** are useful features for toggling between the vessel's current location and the cursor position.

GoTo cursor

You start navigating to a selected position on the image by tapping the screen, then using the go to cursor option in the menu.

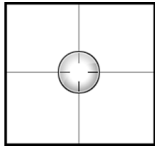

The Cursor assist function

The cursor assist function allows for fine tuning and precision placement of the cursor without covering details with your finger.

Press and hold your finger on the screen to switch the cursor symbol to a selection circle, appearing above your finger.

Without removing the finger from the screen, drag the selection circle over the desired item to display item information.

When you remove your finger from the screen the cursor reverts to normal cursor operation.

Saving waypoints

You can save a waypoint at a selected position by tapping the panel, then selecting the new waypoint option in the menu.

- If your unit has a **MARK** key, you can press this key to immediately save a waypoint. If the cursor is active the waypoint will be saved at cursor position. If the cursor is not active the waypoint will be saved at your vessel's position.

Creating routes

You can create routes by tapping the chart panel.

1. Tap the screen to activate the cursor
2. Select **New** followed by **New route** in the menu
3. Tap the screen to position the first routepoint, and then continue tapping the screen to place the remaining routepoints
4. Save the route by selecting the save option in the menu

→ *Note:* See the Waypoints, routes and tracks section for more information.

Measuring distance



The cursor can be used to measure the distance between your vessel and a selected position, or between 2 points on the chart panel.

1. Tap the screen on the place to where you want to measure the distance from the vessel
2. Start the measure function from the menu
 - The measuring icons will appear with a line drawn from the vessel center to the cursor position, and the distance will be listed in the Cursor Information window
3. Reposition the measuring points by dragging either icon.

→ *Note:* The bearing will always be measured from the grey icon to the blue icon.

You can also start the measuring function without an active cursor. Both measuring icons will then initially be located at the vessel position. The grey icon will follow the vessel as the vessels moves, while the blue icon will remain at the position given when you activated the function.

You terminate the measuring function by tapping **Finish measuring** or by pressing the **X** key.

Find objects on chart panels

You can search for other vessels or various chart items from a chart panel.

Tap the desired location on the panel to search from the cursor position. If the cursor is not active the system will search for items from the vessel's position.

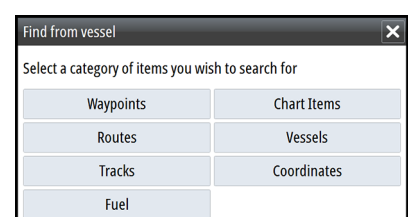

→ **Note:** You must have a SIRIUS data package subscription to search for fueling stations and an AIS receiver connected to search for vessels.

3D charts

The 3D option provides a three dimensional graphical view of land and sea contours.

→ **Note:** All chart types work in 3D mode, but without 3D cartography for the appropriate area the chart will appear flat.

Panning the 3D chart



You can move the chart in any direction by tapping the Pan icon and then dragging your finger in the desired direction.

Press the **X** key or tap the **Return to vessel** menu option to stop panning, and center the chart to vessel position.

Controlling the view angle



You can control the view angle by tapping the rotate icon and then dragging on the screen.

- To change the direction you are viewing, drag horizontally
- To change the tilt angle of the view, drag vertically

→ **Note:** When centered on the vessel position, only the tilt angle can be adjusted. The view direction is controlled by the chart orientation setting. See "*Positioning the vessel on the chart panel*" on page 21.

Zooming a 3D chart

You zoom in and out on a 3D chart by using the zoom panel icons or the rotary knob.

Chart overlay

Radar, Structure, AIS and weather information can be displayed as overlay on your chart panel.

When an overlay is selected, the chart menu will be expanded to include basic function for the selected overlay.

Radar, Structure, AIS and weather functions are described in separate sections in this manual.

Insight specific chart options

Orientation, **Look ahead**, **3D** and **Change to Navionics/Change to Insight** are common for all chart types. These features are described previously in this section.

Chart imagery style

The charts can be displayed in two different imagery styles, either as 2D basic mapping style, or with shaded relief presenting chart including terrain imaging.

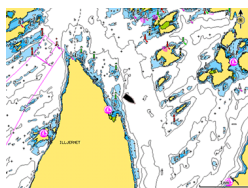
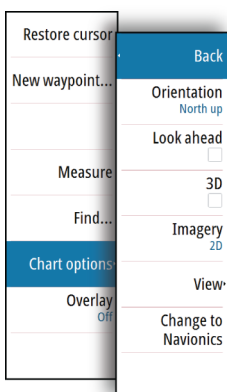

Insight 2D mapping style

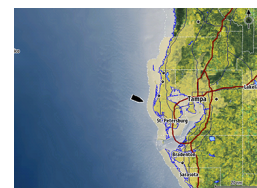

Insight Shaded relief

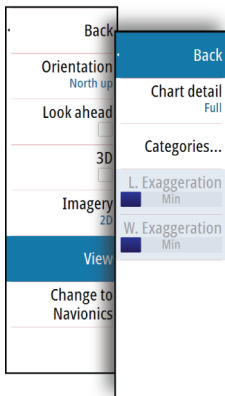

Insight view options

Insight Chart Details

Low	Basic level of information that cannot be removed, and includes information that is required in all geographic areas. It is not intended to be sufficient for safe navigation
Medium	Minimum information sufficient for navigation
Full	All available information for the chart in use

Insight chart categories

Insight charts includes several categories and sub-categories that you can turn on/off individually depending on which information you want to see on your display.

Land Exaggeration and Water Exaggeration

Graphical settings available in 3D mode only. Exaggeration is a multiplier applied to the drawn height of hills on land, and troughs in water to make them look taller or deeper.

Navionics specific chart options

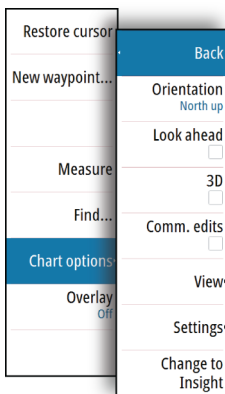

Orientation, **Look ahead**, **3D** and **Change to Navionics/Change to Insight** are common for all chart types. These features are therefore described previously in this section.

Community edits

Toggles on the chart layer including Navionics edits. These are user information or edits uploaded to Navionics Community by users, and made available in Navionics charts.

For more information refer to Navionics information included with your chart, or to Navionics website: www.navionics.com.

Navionics chart settings

Colored Seabed Areas

Used for displaying different depth areas in different shades of blue.

Presentation type

Provides marine charting information such as symbols, colors of the navigation chart and wording for either International or US presentation types.

Annotation

Determines what area information, such as names of locations and notes of areas, is available on display.

Chart details

Provides you with different levels of geographical layer information.

Safety depth

The Navionics charts use different shades of blue to distinguish between shallow and deep water.

The safety depth sets the limit for which depths that shall be drawn without blue shading.

→ **Note:** The built in Navionics database features data down to 20 m, after which it is all white.

Contours depth

Determines which contours you see on the chart down to the selected safety depth value.

Rock filter level

Hides rock identification on the chart beneath a given depth.

This helps you to declutter charts in areas where there are many rocks located at depths well below your vessel draught.

Navionics view options

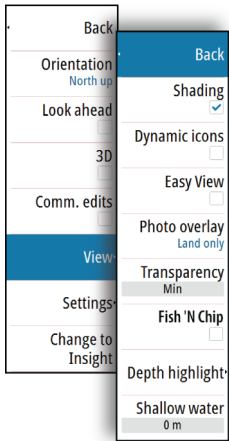

Chart shading

Shading adds terrain information to the chart.

Dynamic tide and current icons

Shows tides and currents with a gauge and an arrow instead of the diamond icons used for static tides and current information.

The tide and current data available in Navionics charts are related to a specific date and time. The NSS evo2 animates the arrows and/or gauges to show the tides and currents evolution over time.

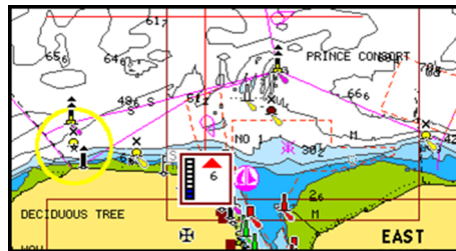

Dynamic tide information

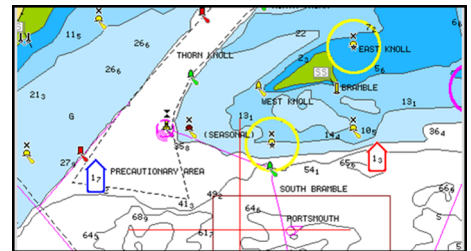

Dynamic current information

The following icons and symbology are used:

Icons	Description
	<p>Current speed.</p> <p>The arrow length depend on the rate, and the symbol is rotated according to flow direction. Flow rate is shown inside the arrow symbol. Red symbol used when current speed is increasing,- blue symbol when current speed is decreasing.</p>
	<p>Tide height.</p> <p>The gauge have 8 labels and is set according to absolute max/min value of the evaluated day.</p> <p>Red arrow used when tide is rising,- blue arrow when tide is falling.</p>

→ *Note:* All numeric values are shown in the relevant system units (unit of measurement) set by user.

Easy View

Magnifying feature increasing the size of chart items and text.

→ *Note:* There is no indication on the chart showing that this feature is active.

Photo overlay

Photo overlay enables you to view satellite photo images of an area as an overlay on the chart. The availability of such photos is limited to certain regions.

You can view photo overlays in either 2D or 3D modes.

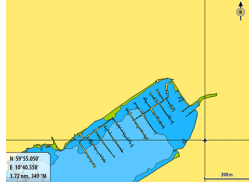

No Photo overlay

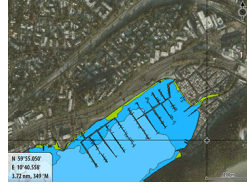
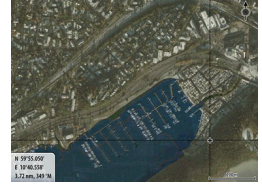

Photo overlay, land only



Full Photo overlay

Photo transparency

The Photo transparency sets the opaqueness of the photo overlay. With minimum transparency settings the chart details will be almost hidden by the photo.

Navionics Fish'n Chip

NSS evo2 supports Navionics Fish'n Chip (US only) chart feature.

For more information, see www.navionics.com.

Depth highlight range

Select a range of depths between which Navionics will fill with a different color.

This allows you to highlight a specific range of depths for fishing purposes. The range will only be as accurate as the underlying chart data, meaning that if the chart only contains 5 meter intervals for contour lines, the shading will round to the nearest available contour line.

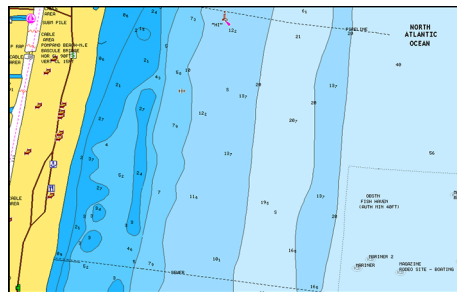

No Depth highlight range

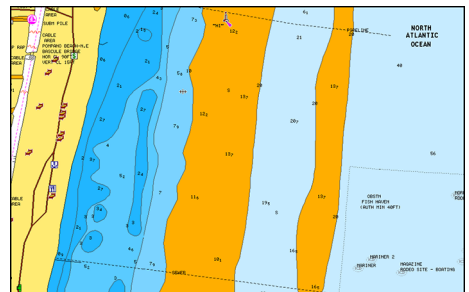

Depth highlight range: 6 m - 12 m

Shallow water highlight

Highlights areas of shallow water.

This allows you to highlight areas of water between 0 and the selected depth (up to 10 meters/30 feet).

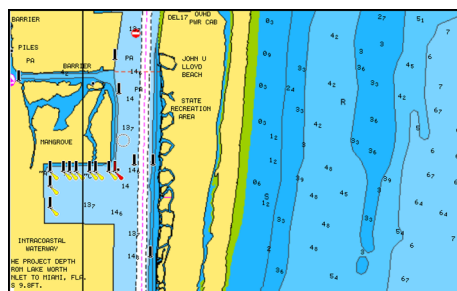

No shallow water highlighted

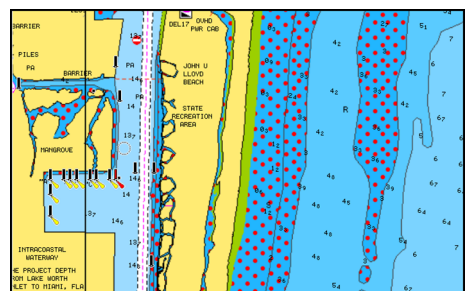

Shallow water highlight: 0 m - 3 m

Chart settings

Settings and display options made in the Chart settings page are common for all chart panels.

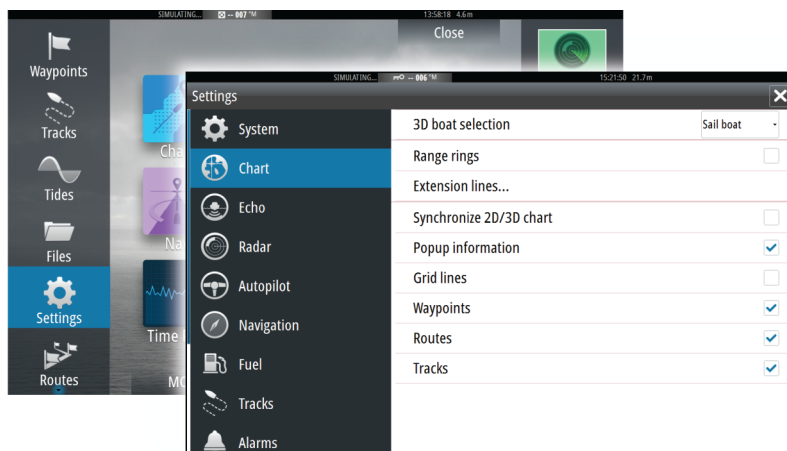

3D boat selection

Determines which icon to use on 3D charts.

Range Rings

The range rings can be used to present the distance from your vessel to other chart objects. The range scale is set automatically by the system to suit the chart scale.

Vessels' extension lines

Sets the length of the extension lines for your vessel and for other vessels shown as AIS targets.

- A: Heading
- B: Course Over Ground (COG)

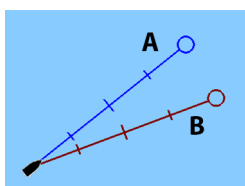

The length of the extension lines are either set as a fixed distance, or to indicate the distance the vessel will move in the selected time period. If no options are ticked on for **This vessel** then no extension lines will be shown for your vessel.

Own vessel heading is based on information from the active heading sensor and COG from active GPS sensor.

For other vessels COG data is included in the message received from the AIS system.

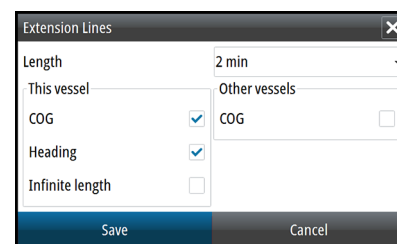

Synchronize 2D/3D chart

Links the position shown on one chart with the position shown on the other chart when a 2D and a 3D chart are shown side by side.

Pop-up information

Selects whether basic information for chart items shall be displayed when you tap the item.

Grid lines

Turns on/off viewing of longitude and latitude grid lines on the chart.

Waypoints, Routes, Tracks

Turns on/off displaying of these items on chart panels.

4

Waypoints, routes and tracks

Waypoints

A waypoint is a user generated mark positioned on a chart, on a radar image or on an echosounder image. Each waypoint has an exact position with latitude and longitude coordinates. A waypoint positioned on an echosounder image, will in addition to position information have a depth value.

A waypoint is used to mark a position you later may want to return to. Two or more waypoints can also be combined to create a route.

Saving waypoints

You can save a waypoint at a selected position by tapping the panel, then selecting the new waypoint option in the menu.

- If your unit has a **MARK** key, you can press this key to immediately save a waypoint. If the cursor is active the waypoint will be saved at cursor position. If the cursor is not active the waypoint will be saved at your vessel's position.

Moving a waypoint

1. Tap the waypoint you want to move
 - The waypoint icon will expand to indicate that it is active
2. Activate the menu and select the move option
3. Tap the chart to select a new position for the waypoint
4. Confirm the new position by pressing the rotary knob

The waypoint is now automatically saved at the new position.

Edit a waypoint

You can edit all information about a waypoint from the Edit waypoint dialog. This dialog is activated by tapping the waypoint's pop-up, by pressing the rotary knob, or from the menu when the waypoint is activated.

The dialog can also be accessed by from the Waypoints tool on the Home page.

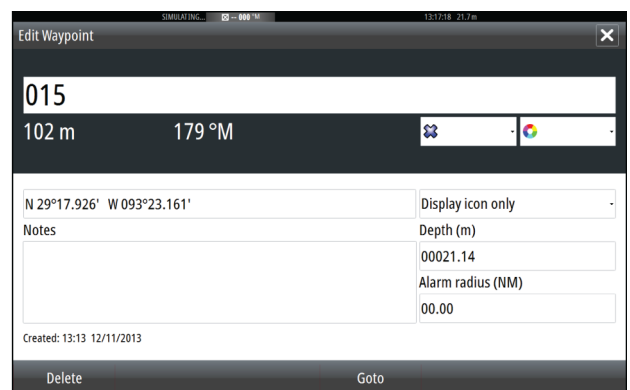
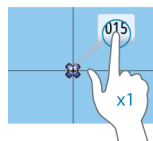

015	
102 m	179 °M
N 29°17.926' W 093°23.161'	
Notes	Display icon only
	Depth (m)
	00021.14
	Alarm radius (NM)
	00.00
Created: 13:13 12/11/2013	
Delete	Goto

Waypoint alarm settings

You can set an alarm radius for each individual waypoint you create. The alarm is set in the Edit waypoint dialog.

- **Note:** The waypoint radius alarm must be toggled ON in the alarm panel to activate an alarm when your vessel comes within the defined radius.

Routes

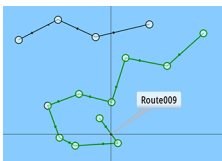

A route consists of a series of routepoints entered in the order that you want to navigate them.

When you tap a route on the chart panel it will turn green, and the route name will be displayed.

Creating a new route on the chart panel

1. Tap the screen to activate the cursor
2. Select the new route option from the menu
3. Tap the chart panel to position the first waypoint
4. Continue tapping the chart panel until all routepoints are positioned
5. Save the route by pressing the save option in the menu.

Creating routes using existing waypoints

You can create a new route by combining existing waypoint from the Routes dialog. The dialog is activated by using the **Routes** tool on the Home page.

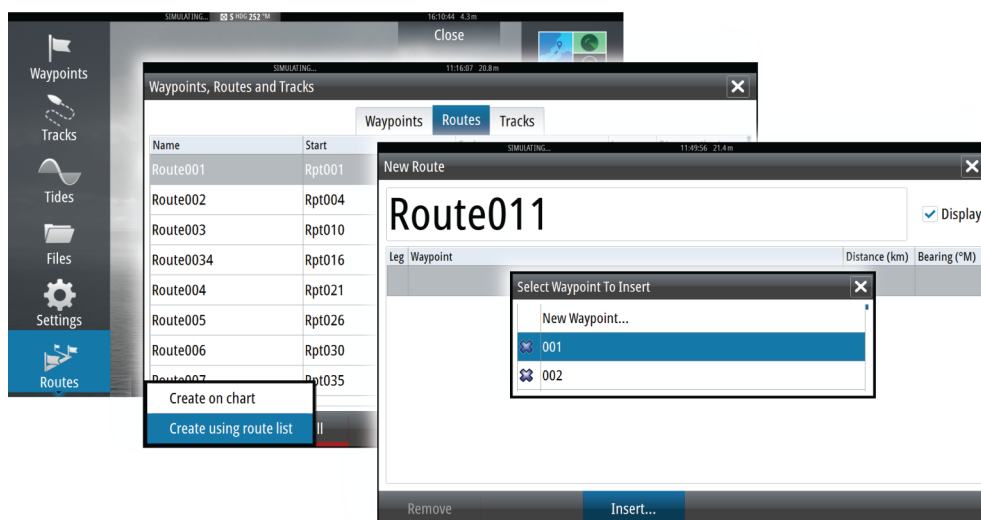

Converting a track to a route

You can convert a track to a route from the **Edit Track** dialog. The dialog is activated by activating the track, then tapping the track's pop-up, pressing the rotary knob or selecting the info options from the menu. The **Edit Track** dialog can also be access by using the **Tracks** tool on the Home page.

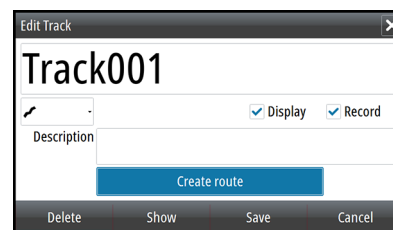

Edit a route from the chart panel

1. Tap the route to make it active
 2. Select the route edit option in the menu
 3. Tap the panel to add a new routepoint
 - If you tap on a leg a new point will be added between existing routepoints
 - If you tap outside the route the new routepoint will be added after the last point in the route
 4. Drag a routepoint to move it to a new position
 5. Save the route by selecting the save option in the menu.
- **Note:** The menu will change depending on the selected edit option. All edits are confirmed or cancelled from the menu.

The Edit Route dialog

You can add and remove routepoints from the **Edit Route** dialog. This dialog is activated by tapping an active route's pop-up, by pressing the rotary knob, or from the menu.

The dialog can also be accessed by using the **Routes** tool on the Home page.



Leg	Waypoint	Distance (km)	Bearing (°M)
0	Rpt040		
1	Rpt041	2.72	256
2	Rpt042	2.04	294
3	Rpt043	2.18	242

Tracks

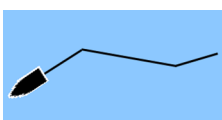

A track is a graphical presentation of the historical path of the vessel, allowing you to retrace where you have travelled. A track can be converted to a route from the Edit Tracks dialog.

From the factory, the system is set to automatically track and draw the vessel's movement on the chart panel. The system will continue to record the track until the track length reaches the maximum track points, and will then automatically begin overwriting the oldest track points.

The automatic tracking function can be turned off from the Tracks dialog.

Creating a new track

You can start a new track from the Tracks dialog, activated by using the Tracks tool on the Home page.

Track settings

The track is made up of a series of track points connected by line segments whose length depends on the frequency of track recording.

You can select to position track points based on time settings, distance, or by letting the NSS evo2 system position a waypoint automatically when a course change is registered.

→ *Note:* The Tracks option must also be turned ON in the chart settings to be visible.

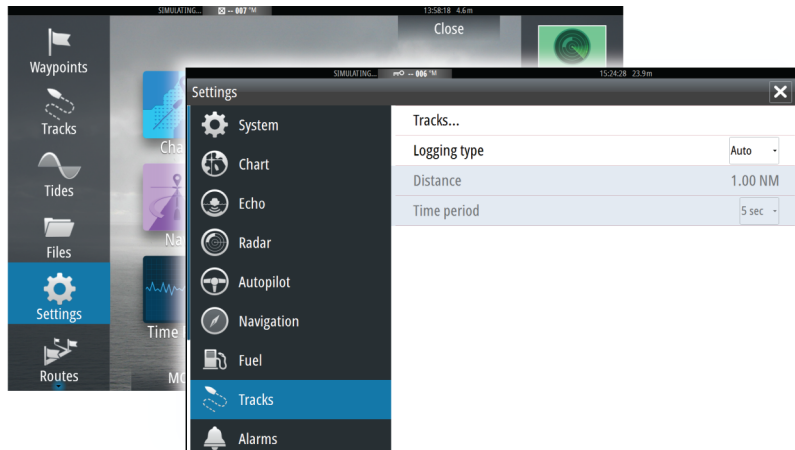

Waypoints, routes and tracks dialogs

The waypoints, routes and tracks dialogs give access to advanced edit functions and settings for these items.

The dialogs are accessed from the tools panel on the Home page.

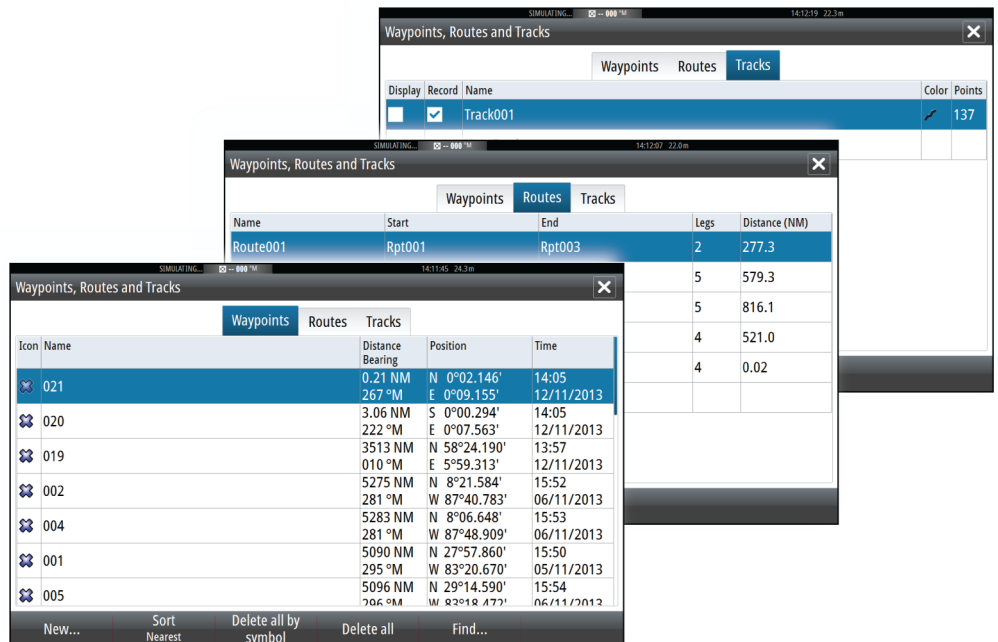

5

Navigating

The navigation function included in the NSS evo2 allows you to navigate towards the cursor position, towards a waypoint or along a predefined route.

If autopilot functionality is included in your system, the autopilot can be set to automatically navigate the vessel.

For information about positioning waypoints and creating routes, refer to "*Waypoints-Routes-Tracks*" on page 29.

Navigation panels

The Nav and Position panels can be used to display information when you are navigating.

The Nav panel

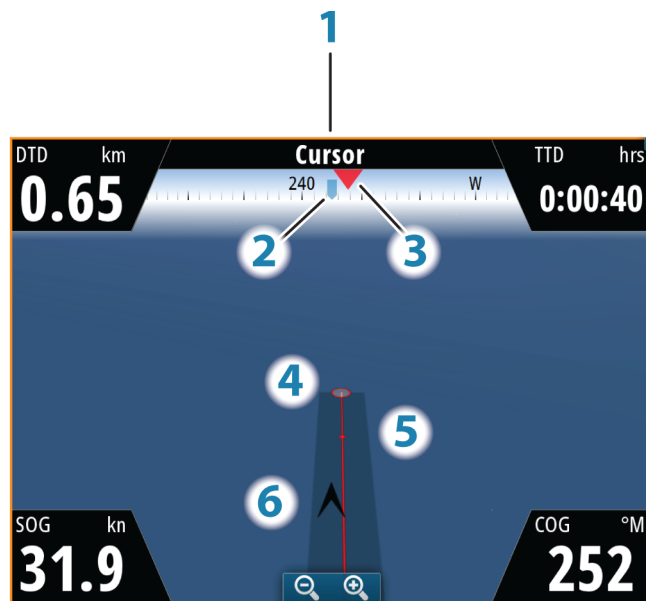

The Nav panel is activated from the Home page, either as a full page panel or as part of a multiple panel page.

Key	Description
1	Name of destination point
2	Vessel heading
3	Bearing to waypoint
4	Destination point
5	Bearing line with allowed off course limit When travelling on a route the bearing line shows the intended course from one waypoint towards the next. When navigating towards a waypoint (cursor position, MOB or an entered lat/lon position), the bearing line will show the intended course from the point at which navigation was started towards the waypoint.
6	Vessel symbol Indicates distance and bearing relative to the intended course. If the XTE (Cross Track Error) exceeds the defined XTE limit, this will be indicated with a red arrow including the distance from the track line. Refer to " <i>XTE limit</i> " on page 36

Data Fields

The Steer panel offers the following information:

DTD	Distance to destination
BTW	Bearing to waypoint
SOG	Speed over ground
COG	Course over ground
TTD	Time to destination
ETA	Estimated time of arrival at next waypoint
VMG	Velocity Made Good towards next waypoint.
STEER	Course to steer towards next waypoint

Position panels

You can switch between displaying the Nav panel or the Position panel. The Position panel is activated from the menu.

By default, there is one position panel available showing GPS position.

If Loran is enabled, there will be two position panels. This is indicated with arrow symbols on left and right side of the panel.

You toggle between the panels by tapping the left or right side of the panel.

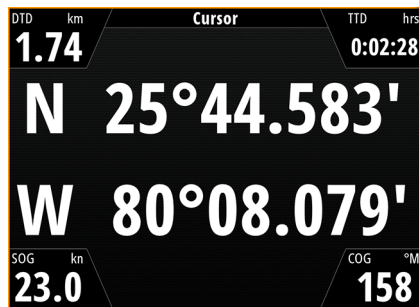

GPS position info

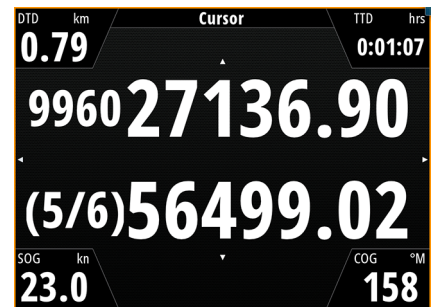

Loran position info

Data fields

Position in lat. and lon. (GPS) or as Loran GRI and station values	
Time and date	
SOG	Speed over ground
COG	Course over ground
DTD	Distance to destination
TTD	Time to destination

Navigate to cursor position

You can start navigating towards cursor position on any chart, radar or echosounder application panel.

Tap the selected destination on the panel, and select the go to cursor option in the menu.

Navigate a route

You can start navigating a route from the chart panel or from the Route dialog.

When route navigation is started, the menu will expand showing options for canceling the navigation, for skipping a waypoint, and for restarting the route from current vessel position.

Starting a route from the chart panel

Tap a route on the panel, and then select the route navigation option from the menu. You can tap a routepoint to start navigating from a selected position.

Start navigating a route from the Route dialog

You can start navigating from the Route dialog, activated by:

- Selecting the Route tool from the Home page
- Selecting the route details from the menu

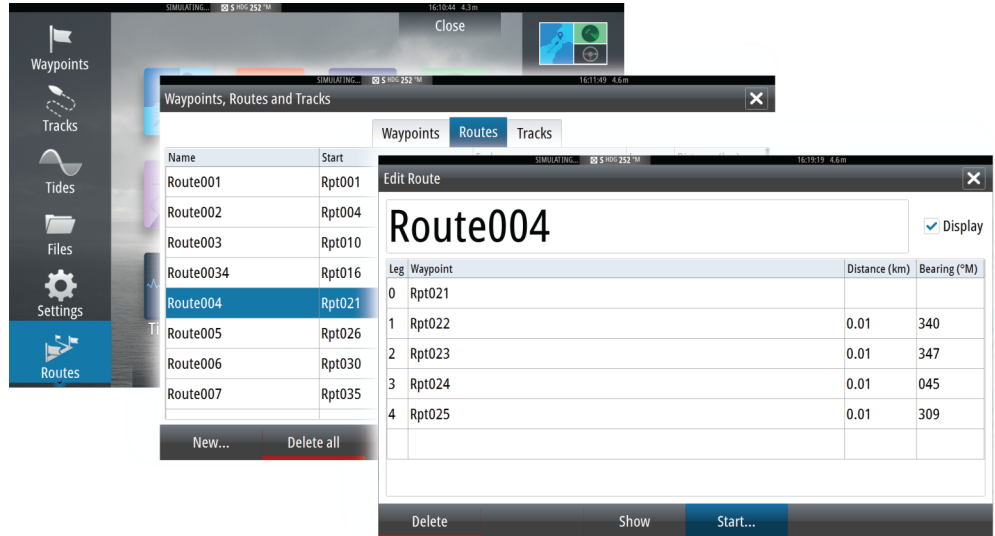

Cancel navigation

When you are navigating a route the menu will include an option for cancelling the route.

Navigating with the autopilot

When you start navigation on a system with autopilot functionality, you will be prompted to set the autopilot to navigation mode.

If you choose not to engage the autopilot, the autopilot can later on still be set to navigation mode from the pilot menu.

For more information about autopilot functionality, refer to *"Autopilot"* on page 37.

Navigation settings

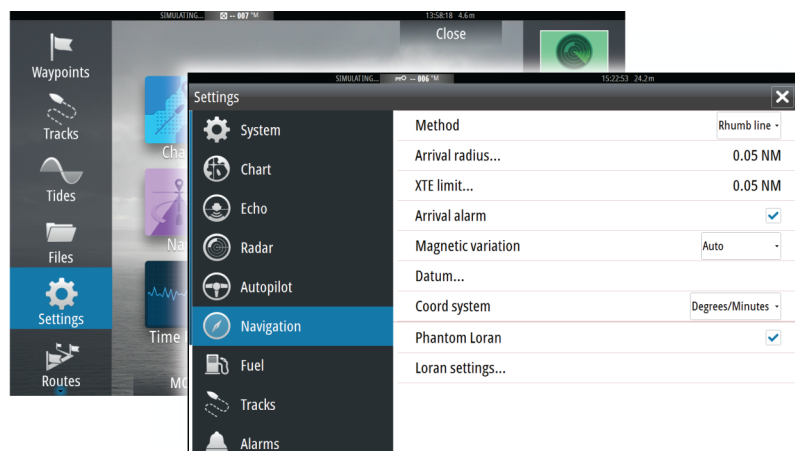

Navigation method

Different methods are available for calculating the distance and bearing between any two points on a chart.

The Great circle route is the shortest path between two points. However, if you are to travel along such a route, it would be difficult to steer manually as the heading would constantly be changing (except in the case of due north, south, or along the equator).

Rhumb lines are tracks of constant bearing. It is possible to travel between two locations using Rhumb line computation, but the distance would usually be greater than if Great circle is used.

Phantom Loran

Enables use of Phantom Loran positioning system.

Loran settings

Defines Loran chains (GRI) and preferred station for waypoint entry, cursor position and position panel.

The graphic example shows cursor position window with Loran position information.

For more information refer to your Loran system documentation.

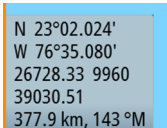

N 23°02.024'
W 76°35.080'
26728.33 9960
39030.51
377.9 km, 143 °M

Arrival radius

Sets an invisible circle around the destination waypoint.

The vessel is considered arrived at the waypoint when it is within this radius.

XTE limit

This parameter defines the vessel's accepted offset distance from the leg. If the vessel goes beyond this limit, an alarm will be activated.

Arrival alarm

When the arrival alarm is enabled, an alarm will be activated when the vessel reaches the waypoint or when its within the specified arrival radius.

Magnetic variation

Magnetic variation is the difference between true bearings and magnetic bearings, caused by different location of the Geographic and the Magnetic north poles. Any local anomalies such as iron deposits might also affect the magnetic bearings.

When set to Auto, the system automatically converts magnetic north to true north. Select manual mode if you need to enter your own local magnetic variation.

Datum

Most paper charts are made in the WGS84 format, which also is used by the NSS evo2 system.

If your paper charts are in a different format, you can change the datum settings accordingly to match your paper charts.

Coordinate system

Several coordinate systems can be used to control the format for lat./lon coordinates displayed on the chart panel.

6

Autopilot

If an AC12N, AC42N or SG05 autopilot computer is connected to the system, autopilot functionality will be available in the NSS evo2.

An Autopilot is designed to maintain an accurate course in various sea conditions with minimal helm movements.

Safe operation with the autopilot

⚠ Warning: An autopilot is a useful navigational aid, but DOES NOT under any circumstances replace a human navigator.

Activating the autopilot

You activate the autopilot from any panel by pressing the **STBY/AUTO** key, followed by tapping the selected mode in the autopilot pop-up.

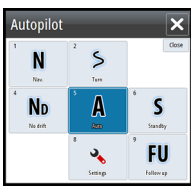

Switching from automatic mode to manual steering

You can switch the autopilot to STBY mode from any automatic operation mode by a short press on the **STBY/AUTO** key.

- **Note:** If the NSS evo2 is connected to an EVC system via the SG05, you can take manual control of the steering irrespective of the autopilot mode. Refer to *"Using the autopilot in an EVC system"* on page 46.

Autopilot indication on the pages

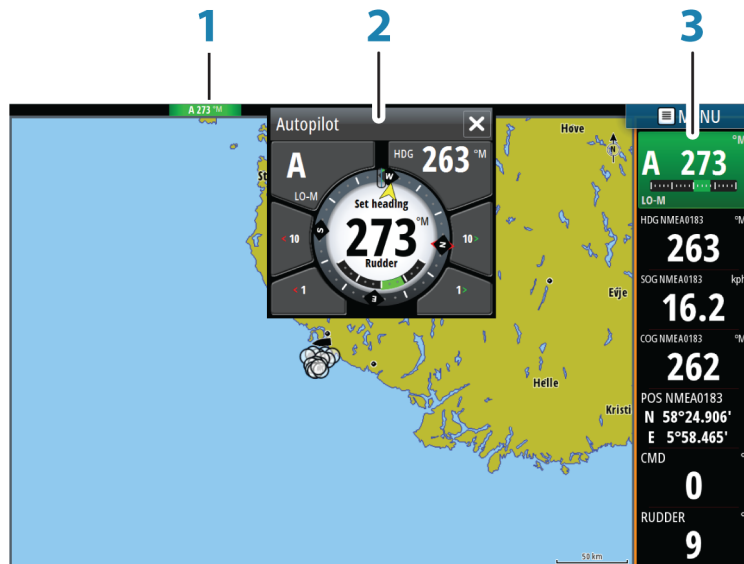

Key	Description
1	Autopilot indication in Status bar
2	Autopilot pop-up
3	Autopilot tile in Instrument bar

S HDG 252 °M

Autopilot mode indication in the Status bar

The Status bar will show autopilot information as long as an autopilot computer is connected to the network.

Icons will be included if the autopilot is passive or locked by another autopilot control unit.

Autopilot pop up

You control the autopilot from the pop-up.

The pop-up has a fixed position on the page, and it is available for all pages except when an Autopilot panel is active.

As long as the autopilot pop-up is active, you cannot operate the background panel or its menu.

You remove the pop-up from a page by tapping the **X** in the upper right corner, or by pressing the **X** key. You turn it on again by pressing and holding the **STBY/AUTO** key, or by tapping the autopilot tile in the instrument bar.

The following pop-ups are available:

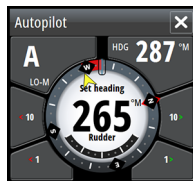

Autopilot controller, showing active mode, heading, rudder and various steering information depending on active autopilot mode. Manual adjustments to the set heading can only be made when the port and starboard arrow indicators are illuminated red and green.



Mode selection, including access to turn pattern selection



Turn pattern selection

Autopilot tile in Instrument bar

You can select to show the autopilot tile in the Instrument bar.

If the autopilot pop-up is turned off you can turn it on by tapping the tile.



The Autopilot panel

The autopilot panel are used to display navigation data. It can be shown as a full screen panel, or in a multi-panel page.

The number of data fields included in the autopilot panel is dependant on available panel size.

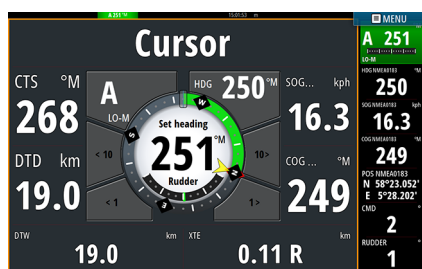

Data fields

The following abbreviations are used in the autopilot panel:

- CTS Course to steer
- DTD Distance to destination
- SOG Speed over ground
- COG Course over ground
- DTW Distance to next waypoint
- XTE Cross track error (L: left or R: right)

Mode overview

The autopilot has several steering modes. Number of modes and features within the mode depend on boat type and available inputs, as shown in table.

Mode	Feature	Description
Standby		Standby mode used when manually steering at the helm. Compass and rudder angle will be shown on the display
NFU		Non-Follow Up steering where the rudder movement is controlled by using the Port and Starboard keys in the Pilot pop-up, or by another NFU unit
FU		Follow-up steering where the rudder angle is set by the rotary knob or by another FU unit
AUTO		Automatic steering where the set heading is maintained.
	Heading capture	Aborts the turn and uses the instantaneous compass reading as set heading
	Turn patterns	Moves the vessel automatically in pre-defined turn steering patterns
	Tacking	Only available if the boat type is set to Sail. Tacking with a fixed angle.
NoDrift		Automatic steering, keeping the vessel on a straight bearing line by compensating for drift
	Dodging	Returns to NoDrift mode after a heading change
NAV		Navigation steering. Steers the vessel to a specific waypoint or through a route
WIND		Only available if the boat type is set to Sail. Automatic steering where the vessel heading is changed to maintain a set wind angle
	Tacking/Gybing	Only available if the boat type is set to Sail. Tacking/Gybing with apparent or true wind angle as reference.
WIND Nav		Automatic steering, using both wind and GPS data to steer the vessel to a specific waypoint or through a route

Standby mode

Standby (STBD) mode is used when you steer the boat at the helm.

- Switch the autopilot to STBY mode from any operation by a short press on the **STBY/AUTO** key.

Non-Follow Up (NFU, Power steering)

In NFU mode you use the port and starboard arrow buttons in the autopilot pop-up to control the rudder. The rudder will move as long as the button is pressed.

- Select NFU mode by tapping the port or starboard arrow button in the pop-up when the autopilot is in STBY or FU mode.

You return to STBY mode by a short press on the **STBY/AUTO** key.

Follow-up steering (FU)

In FU mode you use the rotary knob to set the rudder angle. The rudder will move to the commanded angle and then stop.

- You select FU mode from the autopilot menu

⚠ Warning: While in Follow-up mode you cannot take manual control of the wheel. You return to STBY mode by a short press on the **STBY/AUTO** key.

AUTO mode (auto compass)

In AUTO mode the autopilot issues rudder commands required to steer the vessel automatically on a set heading.

- You select AUTO mode from the autopilot menu. When the mode is activated, the autopilot selects the current boat heading as the set heading.

Changing set heading in AUTO mode

You adjust the set heading by using the rotary knob or the Port/Starboard arrow buttons in the autopilot pop-up.

An immediate heading change will take place. The new heading will be maintained until a new heading is set.

Heading capture

When the vessel is turning in AUTO mode, an instant reset of the mode activates the heading capture function. This will automatically cancel the turn, and the vessel will continue on the heading read from the compass the very moment you re-activated the mode.

Tacking in AUTO mode

→ **Note:** The tack function is only available when the system is set up for SAIL boat type.



Tacking should only be performed into the wind and must be tried out in calm sea conditions with light wind to find out how it works on your boat. Due to a wide range of boat characteristics (from cruising to racing boats) the performance of the tack function may vary from boat to boat.

Tacking in **AUTO** mode is different from tacking in **WIND** mode. In AUTO mode the tack angle is fixed and as defined by the user. For more details, see "*Tacking - WIND mode*" on page 43.

You initiate the tack function from **AUTO** mode.

When tacking direction is selected the autopilot changes the current set course according to the set fixed tacking angle.

You can interrupt the tack operation as long as the tack dialog is open by selecting the opposite tacking direction. When interrupted the boat will return to the previous set heading.

NoDrift mode

NoDrift mode combines the autopilot and the positioning information from the GPS.

In NoDrift mode the vessel is steered along a calculated track line in a direction set by the user. If the vessel's heading is drifting away from the original heading due to current and/or wind, the vessel will follow the line with a crab angle.

1. Turn the vessel to the desired heading
2. Activate the NoDrift mode. The autopilot will draw an invisible bearing line based on current heading from the boat's position

Unlike in AUTO (compass) mode the autopilot will now use the position information to calculate the cross track error, and automatically keep your track straight.

You use the port/starboard arrow panel buttons in the autopilot pop-up or the rotary knob to reset the bearing line while in NoDrift mode.

Dodging

If you need to avoid an obstacle when using NoDrift mode, you can set the autopilot to STBY and power steer or use the helm until the obstacle is passed.

If you return to NoDrift mode within 60 seconds you can select to continue on previous set bearing line.

If you don't respond the dialog will disappear and the autopilot will go to NoDrift mode with current heading as set bearing line.

NAV mode

⚠ Warning: NAV mode should only be used in open waters.

You can use the autopilot to automatically steer the boat to a specific waypoint location, or along a pre-defined route. The position information from the GPS will be used to change the course to steer to keep the boat on the track line and to the destination waypoint.

- *Note:* To obtain satisfactory navigation steering, the NSS evo2 must have valid position input. Autosteering must be tested and determined satisfactory prior to entering the NAV mode.

Start automatic navigating

When you start navigating a route or to a waypoint from the chart panel, you will be prompted to set the autopilot to **NAV** mode. If you reject this request, you can start **NAV** mode from the autopilot mode menu.

When **NAV** mode is initiated, the autopilot will automatically keep the vessel on the leg.

When the vessel reaches the arrival circle for a routepoint, the autopilot will give an audible warning and display a dialog with the new course information. If the required course change to the next waypoint is less than the Navigation change limit, the autopilot will automatically change the course. If the required course change to next waypoint in a route is more than the set limit, you are prompted to verify that the upcoming course change is acceptable.

- *Note:* For information about navigation settings, refer to "*Navigation settings*" on page 35.

Waypoint arrival circle

The Arrival radius defines the point at which a turn is initiated when you are navigating a route.

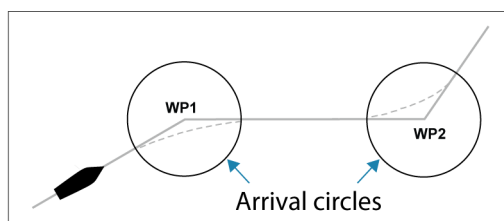

The arrival circle should be adjusted according to boat speed. The higher the speed, the wider the circle. The intention is to make the autopilot start the heading change in due time to make a smooth turn onto the next leg.

The figure below may be used to select the appropriate waypoint circle when creating the route.

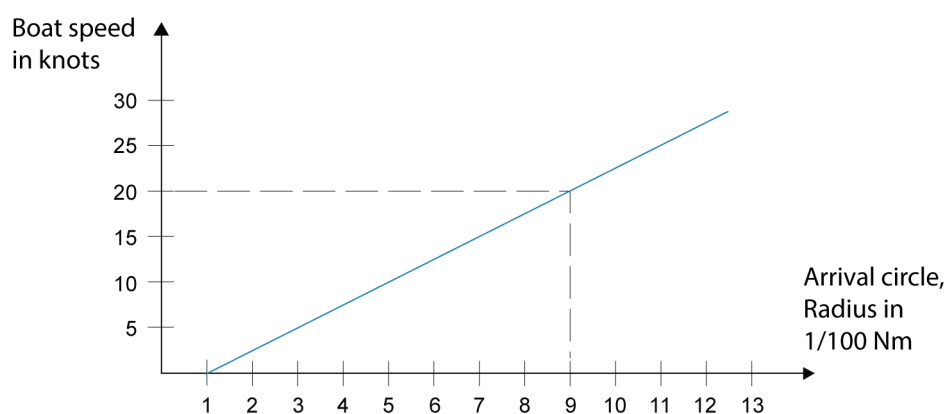

Example: With the speed of 20 knots you should use a waypoint circle with radius 0.09 nm.

- **Note:** The distance between any waypoints in a route must not be smaller than the radius of the waypoint arrival circle when using automatic waypoint shift.

WIND mode

- **Note:** The **WIND** mode is only available if the system has been set up for sailboat in the Autopilot Installation menu.

Before the **WIND** mode is started it must be verified that valid input from wind transducer is available.

Initiate wind steering as follows;

1. Switch the Autopilot to **AUTO** mode
2. Adjust the boat heading until wind angle is according to the angle you want to maintain
3. Tap the mode indication in the autopilot controller to activate the autopilot menu, and select **WIND** mode

The set course to steer (CTS) and set wind angle are entered from the compass heading and the wind transducer at the moment the **WIND** mode is selected. From that point the autopilot will change the course to maintain the wind angle as the wind direction may change.

Tacking in WIND mode

→ **Note:** The tack function is only available when the system is set up for SAIL boat type.

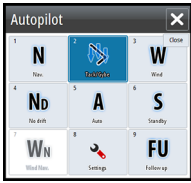

Tacking should only be performed into the wind and must be tried out in calm sea conditions with light wind to find out how it works on your boat. Due to a wide range of boat characteristics (from cruising to racing boats) the performance of the tack function may vary from boat to boat.

Tacking in **WIND** mode as compared to **AUTO** mode is performed when sailing with apparent or true wind as the reference. The true wind angle should be less than 90 degrees. The rate of turn during the tack will be given by the Tack time defined in the sailing parameter setup. The tack time is also controlled by the speed of the boat to prevent loss of speed during a tack.

You can initiate the tack function from **WIND** mode.

When you initiate the tacking, the autopilot will immediately mirror the set wind angle to the opposite side of the bow.

You can interrupt the tack operation as long as the tack dialog is open by selecting the opposite tacking direction. When interrupted the boat will return to the previous set heading.

Gybing

Gybing is possible when the true wind angle is larger than 120°.

The time to make a gybe is determined by the speed of the boat to make it as quick as possible within control.

Tack and gybe prevent

You should use the autopilot with care when beating and running.

If the sails are unbalanced when beating, yaw forces from the sails can drive the boat into the wind. If the boat is driven beyond the set minimum wind angle, the thrust from the sails will suddenly disappear and reduces the boat speed. The boat will then be more difficult to steer as the rudder will become less effective.

The tack prevent function in WIND mode has been implemented to avoid such situations. It will react immediately when the apparent wind angle becomes 5° less than the set minimum wind angle, and more rudder will be commanded.

When running, it is difficult to steer the boat with waves coming sideways or from behind. The waves may yaw the boat into an unwanted gybe; this can be hazardous for both the crew and the mast.

The gybe prevent function will be activated when the actual apparent wind angle becomes greater than 175° or gets opposite to the set wind angle. More rudder will be commanded to prevent an unwanted gybe.

The tack and gybe prevent functions are not a guarantee against getting into a hazardous situation. If the effect of the rudder and/or drive unit is not adequate, a dangerous situation may occur. Pay particular attention in such situations.

WIND Nav mode

In WIND Nav mode the autopilot steers the boat given both wind and position data.

In this mode the autopilot calculates the initial course change needed to navigate towards the active waypoint, but the pilot will also utilize the current wind direction in the calculation.



Turn pattern steering

The autopilot includes a number of automatic turn steering features for power boats when the pilot is in AUTO mode.

- **Note:** The turn steering option will not be available if the boat type is set to sailboat - instead the tack/gybe feature is implemented.

Initiating a turn

You start the turn by tapping the relevant turn icon, followed by tapping the port or starboard options in the turn dialog to select the turn direction.

Stopping the turn

You can stop the turn from within the turn dialog.

You can also at any time during a turn pressing the **STBD/AUTO** key to return to standby mode and manual steering.

Turn variables

All turn steering options, except the C-turn, have settings that you may adjust before you start a turn and at any time when the boat is in a turn.

U-turn

U-Turn changes the current set heading to be 180° in the opposite direction.

The turn rate is identical to Rate limit settings. This cannot be changed during the turn.

- **Note:** Refer to the separate NSS evo2 Installation manual for information about Rate limit settings.

C-turn

C-turn makes the boat turn in a circle.

You can adjust the Rate of turn from the turn dialog before the turn is initiated and during the turn. Increasing the turn rate makes the boat turn a smaller circle.

Spiral turn

Spiral-turn makes the boat turn in a spiral with a decreasing or increasing radius. This feature may be used for circling fish or when searching an object.

You set the initial radius before the turn is initiated, and the change per turn during the turn. If the change per turn is set to zero, the boat will turn in a circle. Negative values indicate decreasing radius while positive values indicate increasing radius.

Zigzag turns

For navigating in a zigzag pattern, you set the initial heading change before the turn is started.

During the turn you can alter the main heading, the heading change and the leg distance.

Square turn

Square-turn makes the boat automatically turn 90° after having travelled a defined leg distance.

You can at any time during the turn change the main heading and the distance of the leg until the boat makes a new 90° turn.

Lazy S-turn

In the lazy-s turn the boat will yaw around the main heading.

You set the selected heading change before the turn is started.

During the turn you can alter the main heading, the heading change and the turn radius from within the turn dialog.

Depth contour tracking, DCT™

If the system has input from an echosounder, the autopilot can be set to follow a depth contour.

⚠ Warning: Do not use this feature unless the seabed is suitable. Do not use it in rocky waters where the depth is varying significantly over a small area.

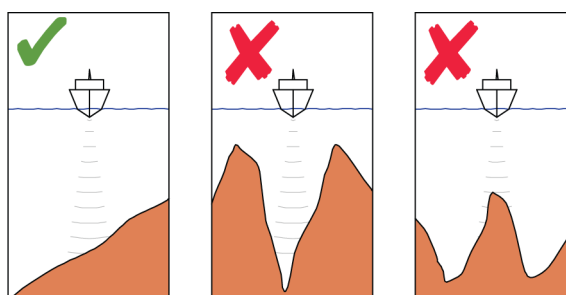

Use the following process to initiate DCT steering;

1. Ensure that you have depth reading on the NSS evo2 or on a separate depth instrument
2. Steer the boat to the depth you want to track, and in the direction of the depth contour
3. Activate **AUTO** mode, select depth contour steering and monitor the depth reading
4. Select the port or starboard option in the turn dialog to initiate the depth contour steering to follow the bottom sloping to starboard or to port

The following parameters are available for depth contour tracking:

Depth gain

This parameter determines the ratio between commanded rudder and the deviation from the selected depth contour. The higher depth gain value the more rudder is applied.

If the value is too small it will take a long time to compensate for drifting off the set depth contour, and the autopilot will fail to keep the boat on the selected depth.

If the value is set too high the overshoot will increase and the steering will be unstable.

Contour Cross Angle CCA

The CCA is an angle that is added to or subtracted from the set course.

With this parameter you can make the boat yaw around the reference depth with lazy-s movements.

The larger the CCA the bigger yawing will be allowed. If you the CCA set to zero there is no S-ing.

Using the NSS evo2 in an AP24/AP28 system

Command transfer

If your NSS evo2 unit is connected to an autopilot system including an AP24 or AP28 control unit, only one control unit can be active at the same time. An inactive NSS evo2 unit is indicated with a square with a cross symbol in autopilot controller pop-up.

You can take command from an inactive NSS evo2 unit by pressing the **STBY/AUTO** key to bring up the mode selection menu, and then confirming active mode.



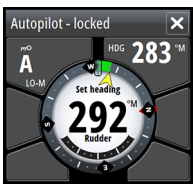

Locking remote stations

The AP24/AP28 includes a Remote Lock function that will disable autopilot control from other units. A locked NSS evo2 unit is indicated with a key symbol in autopilot controller pop-up.

When the remote lock function is enabled on an AP24/AP28 control unit, only the active control unit stays in command. No transfer of command to NSS evo2 or other autopilot control units on the system can take place,

You can only unlock the remote stations from the AP24/AP28 unit in command.

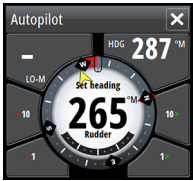

Using the autopilot in an EVC system

When the NSS evo2 is connected to an EVC system via the SG05, you can take manual control of the steering irrespective of the autopilot mode.

The mode indicator on the pilot pop-up will be replaced by a dash to indicate EVC override.

The system will return to NSS evo2 control in standby mode if no rudder command is given from the EVC system within a predefined period.

Autopilot settings

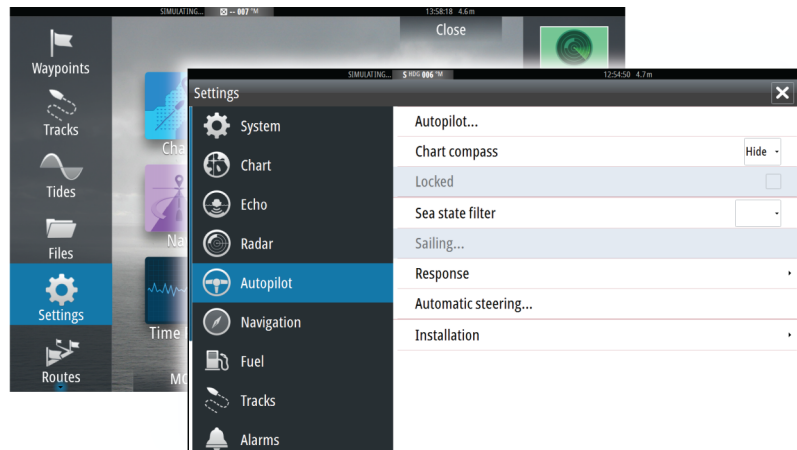
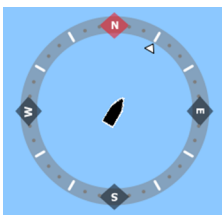

Chart compass



You can select to show a compass symbol around your boat on the chart panel. The compass symbol will be off when the cursor is active on the panel.

Locking autopilot use for other units

If two NSS evo2 units are included in the system, the non-active NSS evo2 unit can be locked to prevent unauthorized operation of the autopilot.

When the unit is locked this is indicated with a lock symbol and with text in the pop up.

When the lock function is in use, no automatic modes can be selected from the NSS evo2 unit.

→ **Note:** The lock function is not available on the NSS evo2 unit which has autopilot control!

If the NSS evo2 unit is part of an AP24/AP28 system, the unit can be locked from the AP24/AP28 control unit.

Sea state filter

The Seastate filter is used to reduce rudder activity and autopilot sensitivity in rough weather.

- OFF Seastate filter is disabled. This is default
- AUTO Reduces rudder activity and autopilot sensitivity in rough weather by an adaptive process. The AUTO setting is recommended if you want to use the seastate filter
- MANUAL Linked to the steering response control settings described previously. It may be used to manually find the optimum combination of course keeping and low rudder activity in rough but steady sea conditions

Sailing parameters

→ *Note:* Sailing parameter settings are only available if the boat type is set to Sail.

Tack time

When performing a tack in WIND mode, the rate of turn (tack time) can be adjusted. This will give single-handed sailors time to handle the boat and the sails during a tack.

A turn performed without shifting wind side, will also be made at a controlled turn rate.

Tack angle

This value is used to preset the course change used when tacking in AUTO mode. By pressing the port and starboard indicators in the autopilot pop-up the course will change as much as this value.

Wind function

With wind function set to AUTO, the autopilot will automatically select between apparent and true wind steering. AUTO is default and recommended for cruising.

When the boat is running, it will also be surfing on the waves. This may lead to significant changes in boat speed, and thereby also changes in apparent wind angle. True wind steering is therefore used when running, while steering to apparent wind is used when beating or reaching.

Apparent wind steering is preferred when you want to achieve maximum boat speed. The autopilot tries to maintain a constant apparent wind angle to get maximum thrust from a given trim of the sails.

When sailing in closed waters, the apparent wind angle may change temporarily due to wind gusts. It may then be preferred to sail to the true wind.

VMG optimizing

You can optimize the VMG to wind. When selected, the function will be active for 5–10 minutes after a new wind angle has been set and only when beating.

Layline steering

Layline steering is useful when navigating. Cross Track Error (XTE) from the navigator will keep the boat on the track line. If the XTE from the navigator exceeds 0.15 nm, the autopilot will calculate the layline and track towards the waypoint.

Response

By default the system switches between HI/LO parameter set based on speed (motor boats) or speed and wind (sail boats). You can however select to manually set which parameter set that shall be used.

HI or LO must be selected if no speed input is available.

You can manually fine tune each of the two (HI/LO) parameter sets. Level 4 is default with parameter values as set by the autotune function. If no autotune is made (not recommended) the level 4 values are the factory default values.

A low response level reduces the rudder activity and provides a more "loose" steering.

A high response level increases the rudder activity and provides a more "tight" steering. A too high response level will make the boat start S-ing.

Automatic steering

This option displays an overview of all autopilot steering parameters, and you can adjust parameters if required.

For more details, refer to the separate NSS evo2 Installation manual.

Installation

Used for autopilot installation and commissioning. See the separate NSS evo2 Installation manual.

7

Radar

The radar panel can be set up as a full screen view or combined with other panels.

The radar image can also be displayed as an overlay to existing 2D and 3D chart views. Refer to the section.

→ *Note:* Radar overlay requires data from heading sensor

The radar panel

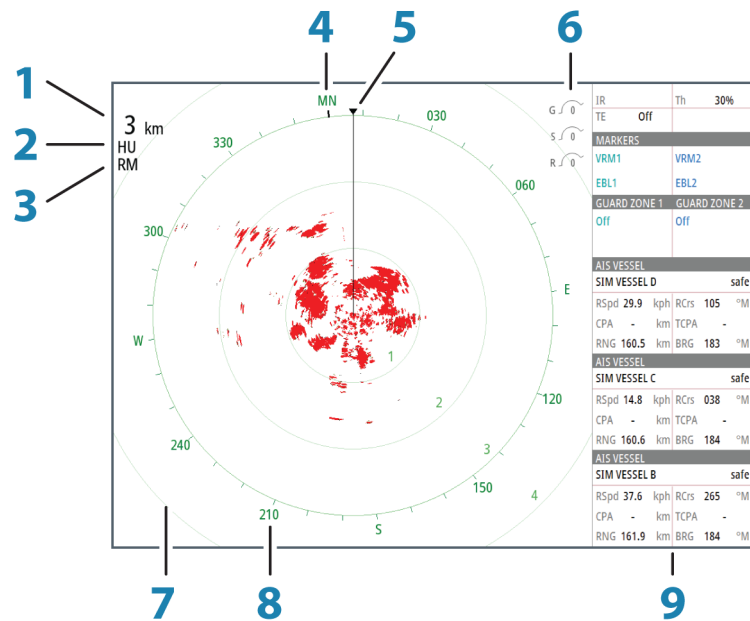

Key	Description	Comment
1	Range	
2	Orientation	
3	Motion	
4	Compass	*
5	Heading line	*
6	Rotary controls	
7	Range rings	*
8	Range markers	*
9	Data bar	

* Optional radar symbology.

Radar symbology can be turned ON/OFF collectively from the Radar menu, or individually as described in the "Radar settings panel" on page 56 section.

Radar overlay

You can overlay the Radar image on the Chart. This can help you to easily interpret the radar image by correlating the radar targets with charted objects.

When the radar overlay is selected, basic radar operational functions are available from the Chart panel's menu.

Radar operational modes

The radar's operational modes are controlled from the NSS evo2 unit. The following modes are available:

Off

The power to the radar scanner is turned off

Standby

The power to the radar scanner is on, but the radar is not transmitting.

Transmit

The scanner is on and transmitting. Detected targets will be drawn on the radar PPI (Plan Position Indicator).

Radar Range

You adjust radar range by turning the rotary knob or by tapping the zoom icons on the radar panel.

Using the cursor on a radar panel

The cursor is by default not shown on a radar panel.

When you tap the radar panel the cursor and the cursor window is activated.

The cursor can be used to measure a distance to a target, and to select targets as described later in this section.

To remove the cursor and cursor elements from the panel, select **Clear cursor** or press the **X** key.

GoTo cursor

You start navigating to a selected position on the image by tapping the screen, then using the go to cursor option in the menu.

The Cursor assist function

The cursor assist function allows for fine tuning and precision placement of the cursor without covering details with your finger.

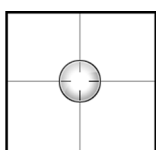

Press and hold your finger on the screen to switch the cursor symbol to a selection circle, appearing above your finger.

Without removing the finger from the screen, drag the selection circle over the desired item to display item information.

When you remove your finger from the screen the cursor reverts to normal cursor operation.

Saving waypoints

You can save a waypoint at a selected position by tapping the panel, then selecting the new waypoint option in the menu.

- If your unit has a **MARK** key, you can press this key to immediately save a waypoint. If the cursor is active the waypoint will be saved at cursor position. If the cursor is not active the waypoint will be saved at your vessel's position.

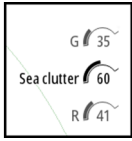

Adjusting the radar image

You may be able to improve the radar image by adjusting the radar sensitivity, and by filtering out the random echoes from sea and weather conditions.

The radar control images are located in the upper right corner of the radar panel. You select between the control images by tapping the image or by pressing the rotary knob. Active control will expand and display its name in full. You can then adjust the value by turning the rotary knob or by using the slide bar.

You can also adjust the image settings from the radar menu.

Gain

The gain controls the sensitivity of the radar receiver.

A higher gain makes the radar more sensitive to radar returns, allowing it to display weaker targets. If the gain is set too high, the image might be cluttered with background noise.

Gain has a manual and an automatic mode. You toggle between automatic and manual mode in the slide bar, or by pressing and holding the rotary knob.

Sea clutter

Sea clutter is used to filter the effect of random echo returns from waves or rough water near the vessel.

When you increase Sea clutter filtering the on-screen clutter caused by the echoes of waves will be reduced.

The system includes predefined Sea clutter settings for harbor and offshore conditions, in addition to the manual mode where you can adjust the settings. You select Sea clutter modes from the menu, or by a long press on the rotary knob. You can only adjust the Sea clutter value in manual mode.

Rain Clutter

The Rain clutter is used to reduce the effect of rain, snow or other weather conditions on the radar image.

The value should not be increased too much as this may filter out real targets.

Rejecting radar interference

Interference could be caused by radar signals from other radar units operating in the same frequency band.

A high setting will reduce the interference from other radars.

In order not to miss weak targets, the interference rejection should be set low when no interference exists.

The radar interference rejection option is available from the menu.

Advanced radar options

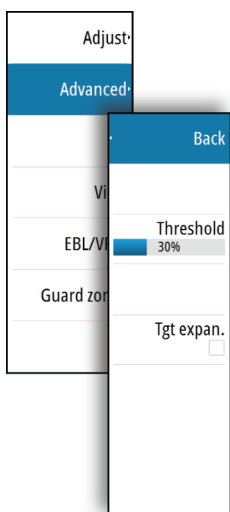

Radar threshold

The threshold sets required signal strength for the lowest radar signals. Radar returns below this limit will be filtered and not displayed.

Default value: 30%.

Target boost

The target boost option is used for increasing the size of radar targets.

Target expansion

Target expansion will override and increase the default radar pulse length, providing larger target returns.

Fast scan

(Broadband Radar™ only).

Increases the speed of the radar scanner when the range is set to 2 nm or less. This option gives faster updates on target movements within this range.

STC curve

(Broadband Radar™ only).

The STC (Sensitivity Time Control) controls the sensitivity of the radar signal close to your vessel. It compensates for distance to the radar object, making returns from equal sized objects appear with the same size on the radar image.

Radar view options

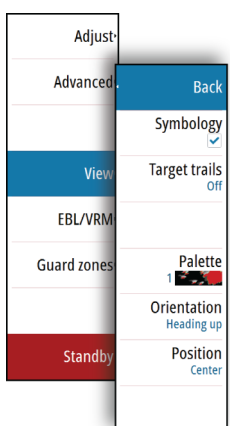

Radar symbology

Radar symbology defined in the the Radar Settings panel can be turned on/off collectively. See the radar panel illustration showing optional radar items.

Target trails

You can define how long time the trail that each target leaves should remain on your radar panel. You can also turn OFF target trails.

→ **Note:** True motion is recommended when using Target trails

Clearing target trails from the panel

When target trails are displayed on the panel, the radar menu will be expanded to include an option where you can clear target trails from your radar panel temporarily. The target trails will start to appear again unless you switch them off as described above.

The radar palette

Different colors (palettes) can be used to represent detail on your radar panel.

Radar orientation

Radar orientation is indicated on the upper left corner of the radar panel as either HU (Heading UP), NU (North Up) or CU (Course up).

Heading up

Rotates the radar image to display the current heading directly up on the radar image.

North up

Rotates the radar image with the north direction upwards.

Course up

Rotates the radar image to display the current navigation course directly up.

This option works only when the NSS evo2 is navigating an active route. If you are not navigating an active route the heading up orientation will be used until the navigation function is started.

Positioning the radar center

You can move the radar PPI center to different positions within the radar panel, and select how your vessel symbol moves on the radar image.

Radar motion is indicated on the upper left corner of the radar panel as either TM (True motion) or RM (Relative motion).

The radar position can only be changed when the radar is transmitting.

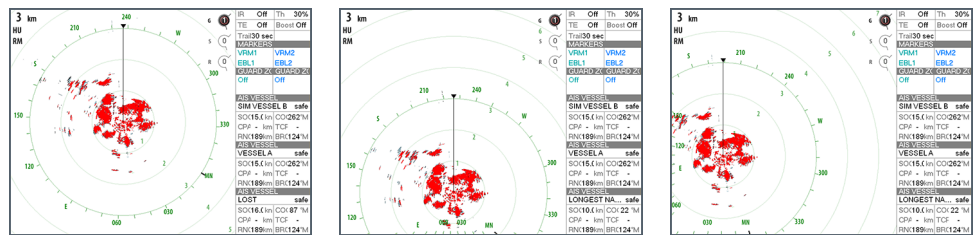

Center

Look ahead

Custom offset

Center

Default setting. The radar PPI center is centered on the radar panel.

Look Ahead

Moves the radar PPI center to the bottom of the panel to give maximum view ahead.

Offset

Allows you to move the PPI center to any location on the radar panel.

1. Select the offset option from the menu
2. Tap the screen where you want to position the radar center
3. Confirm the setting by pressing save offset option in the menu.

True motion

In True motion your vessel, and moving targets, move across the Radar screen as you travel. All stationary objects remain in a fixed position. When the vessel's symbol reaches the edge of the screen, the radar image will be redrawn with the vessel symbol repositioned in center of the screen.

When True motion is selected, the menu will expand to include a reset true motion option. This allows for manually resetting the radar image and vessel symbol to screen center.

EBL/VRM markers

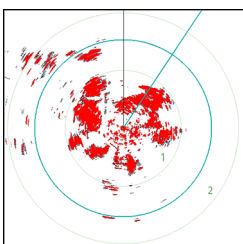

The electronic bearing line (EBL) and variable range marker (VRM) allows quick measurements of range and bearing to vessels and landmasses within radar range. Two different EBL/VRMs can be placed on the radar image.

The EBL/VRM is by default positioned from the center of the vessel. It is however possible to offset the reference point to any selected position on the radar image.

When positioned, you can turn the EBL/VRM on/off by tapping the relevant markers on the data bar or deselect the marker from the menu.

Defining an EBL/VRM marker

1. Ensure that the cursor is not active
2. Activate the menu, select **EBL/VRM**, then select **EBL/VRM 1** or **EBL/VRM 2**
3. Select the adjustment option, and adjust the marker by dragging it into position on the radar panel
4. Select the save option in the menu to save your settings.

Placing EBL/VRM markers by using the cursor

1. Tap the radar panel to position the cursor
2. Activate the menu
3. Select one of the EBL/VRM markers
 - The EBL line and the VRM circle will be positioned according to the cursor position
4. If required, reposition the marker by dragging it into position
5. Select the save option in the menu to save your settings.

Offsetting an EBL/VRM marker

1. Ensure that the cursor is not active
2. Activate the menu, select **EBL/VRM**, then select the marker you wish to offset
3. Select the set offset option
4. Tap the radar panel to set the offset position
5. Select the save option to save your settings.

You can reset the EBL/VRM center to vessel position from the menu.

Setting a guard zone around your vessel

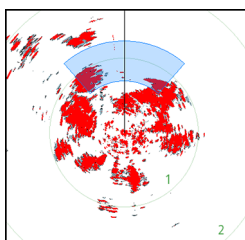

A guard zone is an area (either circular or a sector) that you can define on the radar image. When activated, an alarm will alert you when a radar target enters or exits the zone.

Defining a guard zone

1. Ensure that the cursor is not active
2. Activate the menu, select **Guard zones**, then select one of the guard zones
3. Select the shape for the zone
4. Select **Adjust** to set the range and depth for the guard zone. The values can be set from the menu or by dragging on the radar panel
5. Select the save option in the menu to save your settings.

When positioned, you can turn the guard zones on/off by tapping the relevant section on the data bar.

Alarm settings

An alarm will be activated when a radar target breaches the guard zone limits. You can select if the alarm will be activated when the target enters or exits the zone.

Sensitivity

The guard zone sensitivity can be adjusted to eliminate alarms for small targets.

MARPA targets

If the NSS evo2 system includes a heading sensor, the MARPA function (Mini Automatic Radar Plotting Aid) can be used to track up to ten radar targets.







You can define alarms to notify you if a target gets too close. Refer "*Radar settings panel*" on page 56.

MARPA tracking is an important tool for collision avoidance.

→ *Note:* MARPA requires heading data for both the radar and the NSS evo2.

MARPA target symbols

The NSS evo2 system use the target symbols shown below.

Symbol	Description
	Acquiring MARPA target. Typically it takes up to 10 full rotations of the scanner
	Tracking MARPA target, not moving or at anchor.
	Tracking and safe MARPA target with extension lines.
	Dangerous MARPA target. A target is defined as dangerous when it enters the guard zone defined on the radar panel.
	When no signals have been received within a time limit a target will be defined as lost. The target symbol represents the last valid position of the target before the reception of data was lost.
	Selected MARPA target, activated by tapping the target icon. The target will return to default target symbol when the cursor is removed.

Tracking MARPA targets

1. Tap the target on the radar panel
2. Select Acquire targets from the menu
3. Repeat process for more targets

Once your targets are identified, it may take up to 10 radar sweeps to acquire and then track the target.

Cancelling MARPA target tracking

When targets are being tracked, the radar menu will expand to include options for cancelling individual targets or to stop the tracking function.

Cancel tracking individual targets by tapping the icon before activating the menu.

Viewing MARPA target information

If the pop-up is activated, you can tap a MARPA target to display basic target information. Information for the 3 MARPA targets closest to the vessel is also displayed in the data bar.

When a target is selected, detailed information for the target can be displayed from the menu.

You can display information about all MARPA targets by using the **Vessels** option on the Home page.

MARPA alarm settings

You can define the following MARPA alarms.

Alarm ID	Description
MARPA target lost	Controls whether an alarm shall be activated when a MARPA target is lost
MARPA unavailable	Controls whether an alarm shall be activated if you do not have the required inputs for MARPA to work (valid GPS position and heading sensor connected to the radar server)

Recording radar data

You can record radar data and save the file internally in the NSS evo2 unit, or save it onto an SD card inserted into the unit's card reader.

A recorded radar file can be used for documenting an event or an operational error. A logged radar file can also be used by the simulator.

If more than one radar is available you can select which source you want to record.

Radar settings

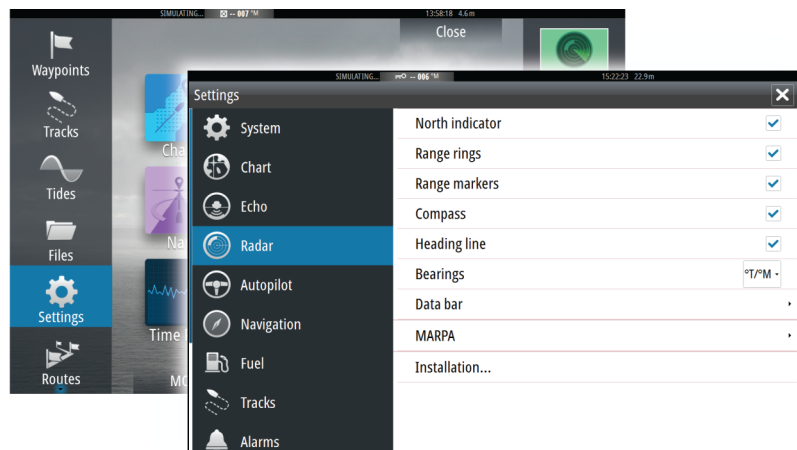

Radar symbology

You can select which optional radar items that should be turned on/off collectively from the menu. Refer to the Radar panel illustration.

Bearings

Used for selecting whether the radar bearing should be measured in relation to True Magnetic North (°T/°M) or to your relative heading (°R).

Data bar

Turns on/off the radar data bar. Refer to the radar panel illustration.

The data bar can show up to 3 targets, arranged with the most dangerous targets on top. You can select to show MARPA targets on top and before any AIS targets, even if the AIS targets are closer to your vessel.

MARPA settings

You can define the length of the MARPA trail making it easier to follow target movement.

A circle can be added around your vessel to present the danger zone. The radius of the the ring is the same as the closest point of approach as set in Dangerous Vessels dialog. See *"Defining dangerous vessels"* on page 76. An alarm will trigger if a vessel is tracking into your safe zone.

Installation

The Installation option is used for radar installation, described in the separate NSS evo2 Installation manual.

8

Echosounder

The echosounder function provides a view of the water and bottom beneath your vessel, allowing you to detect fish and examine the structure of the sea floor.

Except for the NSS evo2 M-versions, all units have built in CHIRP echosounder and StructureScan. The units may be connected to a variety of transducers.

- **Note:** StructureScan and CHIRP can not be operated simultaneously on the NSS evo2. If simultaneous operation is desired, an external module such as the LSS-2, BSM-2 or a second NSS evo2 must be fitted.

The Echosounder image

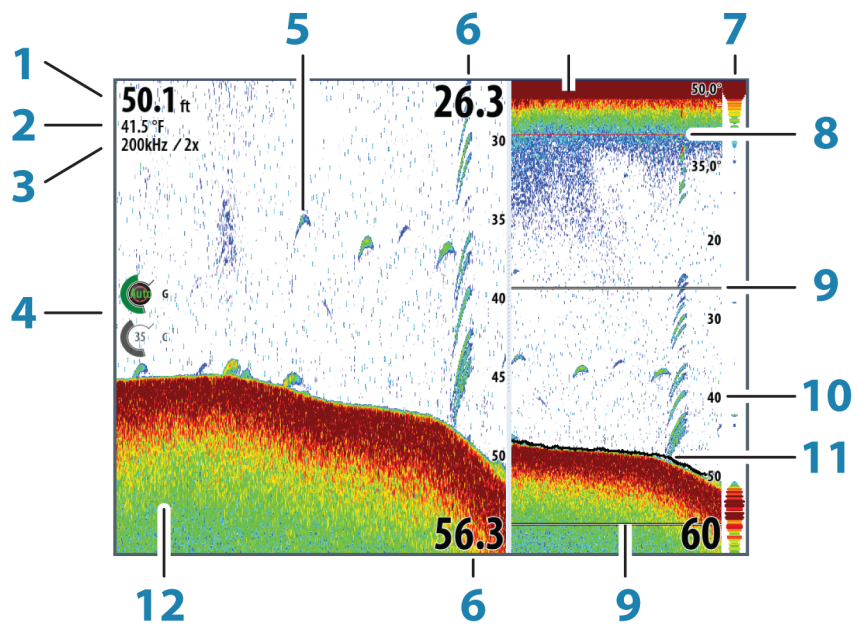

Key	Description	Comment
1	Depth	
2	Temperature	
3	Frequency / Zoom	
4	Gain / Color adjustment icons	
5	Fish arches	
6	Upper and Lower range	
7	A-Scope	*
8	Temperature graph	*
9	Zoom bars	*
10	Range scale	
11	Depth line	*
12	Bottom	

* Optional echosounder image items.

- **Note:** You turn the optional echosounder images on/off individually. See "Echosounder settings panel" on page 63.

Zooming an Echosounder image

You zoom an Echosounder image by:

- turning the rotary knob
 - using the panel zoom icons
 - by pinching or spreading on the screen
- Zoom level is shown on the upper left side of the panel.

When zooming in, the sea floor will be kept near the bottom of the screen, irrespective of whether it is in auto-range or manual range.

If the range is set considerably less than the actual depth, the unit will not be able to find the bottom when zooming.

If the cursor is active, the unit will zoom in where the cursor is pointed.

Zoom bar

The zoom bar will be displayed when you zoom the echosounder image.

Drag the zoom bar vertically to view different parts of the water column.

Using the cursor on the echosounder panel

The cursor can be used to measure a distance to a target, to mark a position, and to select targets.

The cursor is by default not shown on the echosounder image.

When you tap the screen the depth at the cursor position will be shown, the information window and the history bar will be activated.

To remove the cursor and cursor elements from the panel, select **Clear cursor** or press the **X** key.

GoTo cursor

You start navigating to a selected position on the image by tapping the screen, then using the go to cursor option in the menu.

The Cursor assist function

The cursor assist function allows for fine tuning and precision placement of the cursor without covering details with your finger.

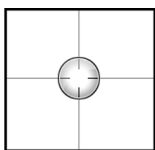

Press and hold your finger on the screen to switch the cursor symbol to a selection circle, appearing above your finger.

Without removing the finger from the screen, drag the selection circle over the desired item to display item information.

When you remove your finger from the screen the cursor reverts to normal cursor operation.

Measuring distance

The cursor can be used to measure the distance between the position of two observations on the image.

It is easier to use the measuring function when the image is paused.

1. Tap the item from where you want to measure the distance
2. Start the measuring function from the menu
3. Tap on the screen to select the second measuring point
 - A line will be drawn between the measuring points, and the distance will be listed in the Information window
4. Continue tapping the screen to position new measuring points

You can use the menu to re-position the start point and the end point as long as the measuring function is active.

When you select **Finish measuring** or press the **X** key, the image will resume to normal scrolling.

Saving waypoints

You can save a waypoint at a selected position by tapping the panel, then selecting the new waypoint option in the menu.

- If your unit has a **MARK** key, you can press this key to immediately save a waypoint. If the cursor is active the waypoint will be saved at cursor position. If the cursor is not active the waypoint will be saved at your vessel's position.

Viewing sounder history

You can view echosounder history by tapping the panel, and then panning the echosounder image.

Whenever the cursor is shown on a sounder panel, the scroll bar is shown at the bottom of the panel. The scroll bar shows the image you are currently viewing in relation to the total echosounder image history stored.

If the scroll bar is on the far right side, it indicates that you are viewing the latest soundings. If you position the cursor to the left side of the screen, the history bar will start scrolling towards left, and the automatic scrolling as new soundings are received will be turned off.

To resume normal scrolling, select **Clear cursor** or press the **X** key.

Setting up the Echosounder image

The range

The range setting determines the water depth that is visible on the screen.

Auto range

If you select Auto, the system will automatically display the whole range from the water surface to the bottom.

Preset range levels

You can select between several preset range levels.

Custom range

This option allows you to manually set both upper and lower range limits.

The echosounder panel can be setup as a single view, or with split view where the left and the right side presents different images.

Echo frequency

The NSS evo2 unit supports several transducer frequencies. Available frequencies depend on sounder module and which transducer model is connected.

You can view two frequencies at the same time by setting up a dual echosounder.

Color and gain settings

Gain and Color control images are located in the left side of the echosounder panel. You select between the control images by tapping the image or by pressing the rotary knob. Active control will expand and display its name in full. You can then adjust the value by turning the rotary knob or by using the slide bar.

You can also adjust the image settings from the echosounder menu.

Gain

The gain controls the sensitivity of the echosounder.

The more you increase the gain, the more details will be shown on the image. However, a higher gain setting may introduce more background clutter on the image. Conversely, if the gain is set too low weak echoes may not be displayed.

Auto gain

The Auto gain option will keep the sensitivity at a level that works well under most conditions.

With the gain in auto mode, you can set a positive or negative offset that gets applied to the auto gain. This is indicated as A-40 - A40.

Color

Strong and weak echo signals have different colors to indicate the different signal strengths. The colors used depend on which palette you select.

The more you increase the Color setting, the more echoes will be displayed in the color at the strong return end of the scale.

Pausing the echosounder

You can pause the sounder, allowing you to examine the sounder echoes.

This function is useful when you need to position a waypoint exactly on the echosounder panel, and if you are using the cursor to measure a distance between 2 elements on the image.

Advanced Echosounder options

Noise rejection

Signal interference from bilge pumps, engine vibration and air bubbles can clutter the image.

The noise rejection option filters the signal interference and reduces the on-screen clutter.

TVG

The TVG (Time Variable Gain) option compensate for distance to the object, making echoes from equal sized objects appear with the same size on the echosounder image.

Scroll speed

You can select the scrolling speed of the echosounder image on the screen. A high scroll speed will update the image fast, while a low scroll speed will present a longer history.

The ping speed

The Ping Speed controls the rate the transducer transmits into the water. A high ping speed will make the image move fast on the screen, while a low ping speed will present a longer history on the screen. The reverberation potentially caused by too high ping speed can cause interference on the screen.

Recording echosounder data

You can record echosounder and StructureScan data and save the file internally in the NSS evo2 unit, or save it onto an SD card inserted into the unit's card reader.

The function is activated from the **Advanced** menu option.

The following options are available:

Bytes per sounding

Select how many bytes per seconds that are to be used when saving the log file. More bytes yield better resolution, but will cause the record file to increase in size compared to using lower byte settings.

Log all channels

Logs all available sonar data simultaneously.

When logging all channels, logs are saved in .sl2 format instead of .slg format.

Log in XTF format

Optional logging format for SideScan data. This will only be shown when StructureScan data is available.

This format does not log all channels into one file. The format is used for third party application support on PC (like SonarWiz) that needs access to the StructureScan data.

Create StructureMap when completed

If StructureScan is available on the network, you can convert the loggings to StructureMap format (.smf) after recording. The file can also be converted to StructureMap format from the Files option.

Viewing the recorded sounder data

Both internally and externally stored sounder records may be reviewed when selected.

The log file is displayed as a paused image, and you control the scrolling and display from the replay menu.

You can use the cursor on the replay image, and pan the image by tapping and dragging on the screen as on a normal echo image.

If more than one channel was recorded in the selected echo file, you can select which channel to display.

You exit the replay mode by pressing the **X** key or the symbol in the upper right corner.

Echosounder view options

Split screen options

Zoom

The Zoom mode presents a magnified view of the sounder image on the left side of the panel.

By default the zoom level is set to 2x. You can select up to 8x zoom from the drop-down menu.

The range zoom bars on the right side of the display shows the range that is magnified. If you increase the zooming factor the range will be reduced. You will see this as reduced distance between the zoom bars.

Bottom lock

The bottom lock mode is useful when you want to view echoes close to the bottom.

In this mode the left side of the panel shows an image where the bottom is flattened. The range scale is changed to measure from the seabed (0) and upwards. The bottom and the zero line will always be shown on the left image, independent on range scale.

The scaling factor for the image on the left side of the panel is adjusted as described for the Zoom option.

Palettes

You can select between several display palettes optimized for a variety of fishing conditions.

Temperature graph

The temperature graph is used to illustrate changes in water temperature.

When toggled on a colored line and temperature digits are shown on the echosounder panel.

Depth line

A depth line can be added to the bottom surface to make it easier to distinguish the bottom from fish and structure.

A-Scope

The A-scope is a display of real-time echoes as they appear on the panel. The strength of the actual echo is indicated by both width and color intensity.

Zoom bars

The zoom bars shows the range that is magnified on a split panel with zoom view.

Fish ID

You can select how you want the echoes to appear on the screen. You can also select if you want to be notified by a beep when a fish ID appear on the panel.

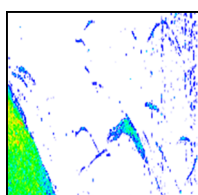

Traditional fish echoes

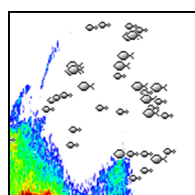

Fish symbols

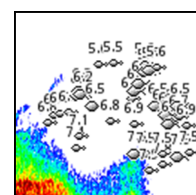

Fish symbols and depth indication

→ *Note:* Not all fish symbols are actual fish.

Echosounder settings

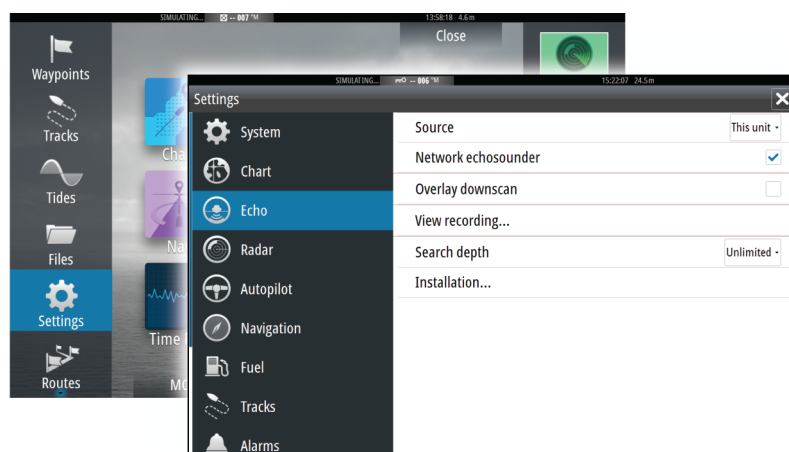

Echosounder source

If you have more than one echosounder on your network, you can select which sounder to be the preferred source on this NSS evo2 unit.

Network echosounder

You can share the echosounder connected to this NSS evo2 unit on the network.

For more information about how to setup echosounders, refer to the separate NSS evo2 Installation manual.

Overlay downscan

When a StructureScan unit is connected to your NSS evo2 system, you can overlay DownScan images on the regular echo image.

When activated, the echosounder menu will expand to include basic StructureScan options.

View echosounder recording

Used to view internally stored echosounder recordings.

The log file is displayed as a paused image, and you control the scrolling and display from the menu.

You can use the cursor on the image, measure distance and set view options as on a live echosounder image. If more than one channel was recorded in the selected echosounder file, you can select which channel to display.

You exit the view function by tapping the **X** in the upper right corner.

Search depth

Noise may cause the echosounder to search for unrealistic depths.

By setting the search depth manually the system will only display echoes received from objects within the set depth range.

Installation

Used for echosounder installation and setup. See the separate NSS evo2Installation manual.

9

StructureScan™

StructureScan HD™ uses high frequencies to provide a high resolution, picture-like image of the seabed.

StructureScan™ provides a 150 m (480 ft) wide coverage in high detail with SideScan, while the DownScan™ provides picture perfect images of structure and fish directly below your boat, down to 90 m (300 ft).

StructureScan™ is integrated on NSS evo2Combo units. For NSS evo2Mapping units an optional hardware module must be connected to use the StructureScan features.

The StructureScan™ image

The view

The StructureScan panel can be set up as a traditional downscan image, or showing left/right side scanning.

The DownScan image can also be added as an overlay to the traditional Echosounder image.

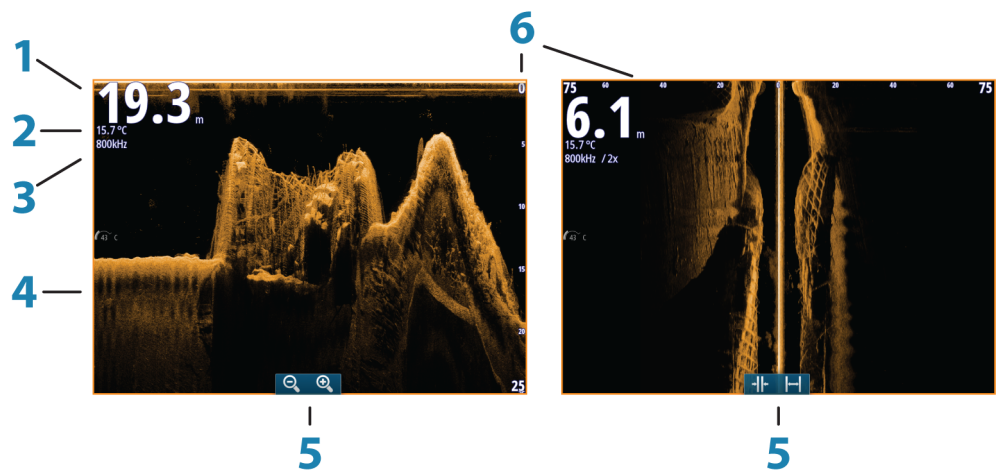

Key	Description
1	Depth
2	Temperature
3	Frequency
4	Bottom
5	Zoom (downscan) / Range (sidescan) icons
6	Range scale

Zooming the StructureScan image

You zoom a StructureScan image by:

- turning the rotary knob (when the cursor not is active)
- using the panel zoom icons
- by pinching or spreading on the screen

Zoom level is shown on the upper left side of the panel.

Using the cursor on the StructureScan™ panel

The cursor is by default not shown on the StructureScan image.

When you tap the screen the cursor will appear, and the information window and the history bar will be activated. On a SideScan image the left/right distance from the vessel to the cursor are shown at the cursor position. On a DownScan image the depth will be shown at cursor position.

To remove the cursor and cursor elements from the panel, press **X** key or select the **Clear cursor** option.

GoTo cursor

You start navigating to a selected position on the image by tapping the screen, then using the go to cursor option in the menu.

The Cursor assist function

The cursor assist function allows for fine tuning and precision placement of the cursor without covering details with your finger.

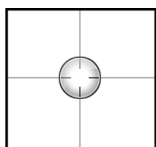

Press and hold your finger on the screen to switch the cursor symbol to a selection circle, appearing above your finger.

Without removing the finger from the screen, drag the selection circle over the desired item to display item information.

When you remove your finger from the screen the cursor reverts to normal cursor operation.

Measuring distance

The cursor can be used to measure the distance between the position of two observations on the image.

It is easier to use the measuring function when the image is paused.

1. Tap the item from where you want to measure the distance
2. Start the measuring function from the menu
3. Tap on the screen to select the second measuring point
 - A line will be drawn between the measuring points, and the distance will be listed in the Information window
4. Continue tapping the screen to position new measuring points

You can use the menu to re-position the start point and the end point as long as the measuring function is active.

When you select **Finish measuring** or press the **X** key, the image will resume to normal scrolling.

Saving waypoints

You can save a waypoint at a selected position by tapping the panel, then selecting the new waypoint option in the menu.

- If your unit has a **MARK** key, you can press this key to immediately save a waypoint. If the cursor is active the waypoint will be saved at cursor position. If the cursor is not active the waypoint will be saved at your vessel's position.

Viewing StructureScan™ history

Whenever the cursor is active on a StructureScan panel, the scroll bar is shown at the bottom of the panel. The scroll bar shows the image you are currently viewing in relation to the total StructureScan image history stored.

Depending of the view selected, the scroll bar is on the far right side (DownScan) or at the bottom of the screen (SideScan).

You can pan the image history by dragging up/down (SideScan) or left/right DownScan.

To resume normal StructureScan scrolling, press **Clear cursor**.

Setting up the StructureScan image

Range

The range setting determines the water depth that is visible on the screen.

Auto range

When the range is set to Auto the system will automatically set the range depending on the water depth.

Preset range levels

You can select between several preset range levels.

Custom range

This option allows you to manually set both upper and lower range limits.

The StructureScan panel can be set up as a single view, or with split view where the left and the right side presents different images.

StructureScan frequencies

StructureScan supports two frequencies. 455 kHz is ideal for greater depth penetration and while 800 kHz provides better definition especially at shallower depths.

Contrast

The contrast determines the brightness ratio between light and dark areas of the screen. This makes it easier to distinguish object from the background.

To adjust the contrast setting:

1. Tap the contrast icon or activate the contrast option in the menu
 - The color adjustment bar is displayed
2. Drag the bar or use the rotary knob to set the value

Palettes

You can select between several display palettes optimized for a variety of fishing conditions.

Pausing the StructureScan image

You can pause the StructureScan image, allowing you to examine the structures and other images in more depth and detail.

This function is useful when you need to position a waypoint exactly on the StructureScan image, and if you are using the cursor to measure a distance between 2 elements on the image.

Recording StructureScan data

You can record StructureScan data and save the file internally in the NSS evo2 unit, or onto an SD card as described in *"Recording echosounder data"* on page 61.

Advanced StructureScan settings

Noise rejection

Signal interference from bilge pumps, engine vibration and air bubbles can clutter the image.

The noise rejection option filters the signal interference and reduces the on-screen clutter.

TVG

The TVG (Time Variable Gain) option compensate for distance to the object, making echoes from equal sized objects appear with the same size on the echosounder image.

Flipping the Structure image left/right

If required, the left/right SideScanning images can be flipped to match the corresponding side of you vessel.

Range Lines

Range lines can be added to the image to make it easier to estimate depth (Downscan) and distance (SideScan).

10

StructureMap

The StructureMap™ feature overlays SideScan images from a StructureScan source on the map. This makes it easier to visualize the underwater environment in relation to your position, and aids in interpreting SideScan images.

The StructureMap image

The example below shows a chart panel with Structure overlay, combined with a traditional SideScan panel.

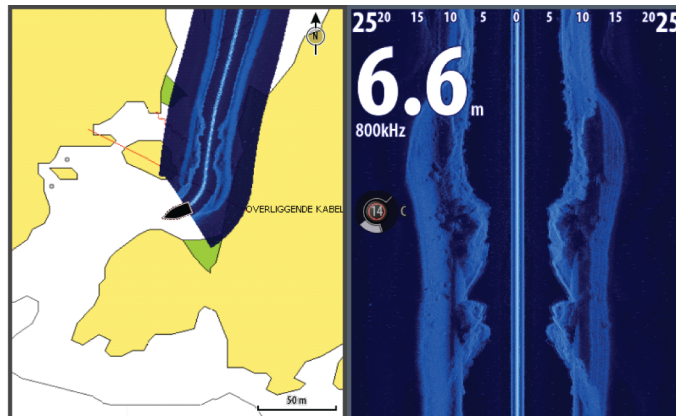

You move around in the chart as usual when you have a Structure overlay;

- zoom the chart and the scanned image by turning the rotary knob, by using the zoom icons, or by using pinch and spread gesture
 - move the chart to view the scanned image by dragging your finger in the selected direction
- Pressing the **X** key or selecting the **Clear cursor** option will remove the cursor from the panel, and the chart center will be positioned at the vessel.

Activating Structure overlay

1. Turn on Structure overlay from the chart menu
 - The chart menu will be increased to show Structure options
 - Structure data will start to appear on the chart screen as soon as Structure overlay is enabled
 2. Select Structure source
 - Live data is default
- *Note:* Structure overlay can also be activated by selecting a saved StructureMap file in the files browser.

StructureMap sources

Two sources can be used to overlay Structure logs on the charts;

- Live data, used when StructureScan units are connected to the NSS evo2 system
- Saved files. These are recorded StructureScan (*.sl2) data that are converted to StructureMap (*.smf) format. Saved *.smf files can be used on NSS evo2 units even if no StructureScan units are connected.

Live source

When live data is selected the SideScan imaging history is displayed as a trail behind the vessel icon. The length of this trail will vary depending on available memory in the unit and range settings. As the memory fills up the oldest data will automatically be deleted as new data is added. When increasing the search range the ping speed of the StructureScan transducer is reduced, but the width and the length of the image history will be increased.

- *Note:* Live mode does not save any data. If the unit is turned off, all recent data is lost.

Saved files

When Saved files are selected, the StructureMap file is overlaid on the map based on position information in the file.

If the chart scale is large, the StructureMap area will be indicated with a boundary box until the scale is large enough to show Structure details.

Saved mode is used to review and examine StructureMap files, and to position the vessel on specific points of interest on a previous scanned area.

- *Note:* When saved files are used as source, the NSS evo2 displays all StructureMap files found on the SD card and in the system's internal memory. If there is more than one StructureMap of the same area, the images will overlap and clutter the chart. If several logs of the same area are required, the maps should be put on separate SD cards.

StructureMap tips

- To get a picture of taller structure (a wreck, etc) — don't drive over it. Steer the boat so the structure will be on the left or right side of your boat
- Don't use Autorange when using SideScan. Set your structure range to a significantly greater level (two-to-three times) than the water depth to ensure a complete scan and to maximize conversion accuracy
- Don't overlap history trails when conducting a side-by-side scan of an area

Recording StructureScan data

StructureScan data can be recorded from a chart panel with Structure overlay enabled.

StructureScan recordings can also be started from a StructureScan panel.

When StructureScan data is being recorded, there will be a flashing red symbol and a message will appear periodically at the bottom of the screen.

- *Note:* The message includes information about file size. Keep the size of your sonar logs to 100MB or less to allow for faster file conversion.

The sounder recording is stopped by re-selecting the record function.

Converting StructureScan data to StructureMap format

A StructureScan log file (.sl2) is converted to StructureMap format (.smf) after recording from the recording dialog, or from the files browser.

You can create standard or high resolution files. High resolution .smf files capture more detail, but take longer to convert and are larger than standard resolution files.

To save disc space it is recommended to remove the StructureScan (*.sl2) files after conversion.

Using StructureMap with mapping cards

StructureMap allows you to maintain full chart capability and can be used with embedded cartography as well as Navionics, Insight and other third-party charting cards compatible with the NSS evo2 systems.

When using StructureMap with mapping cards, copy the StructureMap (.smf) files to the unit's internal memory. We recommend keeping copies of StructureMap files on external SD cards.

Structure options

You adjust the StructureMap settings from the Structure options menu. The menu is available when Structure overlay is enabled.

Not all options are available when saved StructureMap files are used as source. Unavailable options are greyed.

Range	Sets the search range
Transparency	Sets the opaqueness of the Structure overlay. With minimum transparency settings the chart details will be almost hidden by the StructureMap overlay
Palette	Selects Structure palette
Contrast	Determines the brightness ratio between light and dark areas of the screen.
Water column	Shows/hides the water column in Live mode. If turned OFF schools of bait fish might not be seen on the SideScan image. If turned ON the accuracy of the SideScan image on the map might be affected by the water depth.
Frequency	Sets the transducer frequency used by the unit. 800 kHz offers the best resolution, while 455 kHz has greater depth and range coverage
Noise rejection	Filters the signal interference and reduces the on-screen clutter
Clear live history	Clears existing live mode history trails from the screen and begins showing only the most current data
Record data	Records StructureScan data
Source	Selects StructureMap source

11

AIS

If an NAIS400, an AI50 or a NMEA 2000 VHF that can do AIS (Automatic Identification System) is connected to the NSS evo2 system, any targets detected by this devices can be displayed and tracked. You can also see messages and position for DSC transmitting devices within range.

AIS targets can be displayed as overlay on radar and chart images, making this feature an important tool for safe travelling and collision avoidance.

You can define alarms to notify you if an AIS target gets too close or if the target is lost.

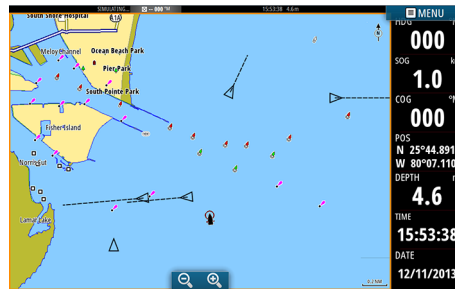

AIS vessels on a chart panel

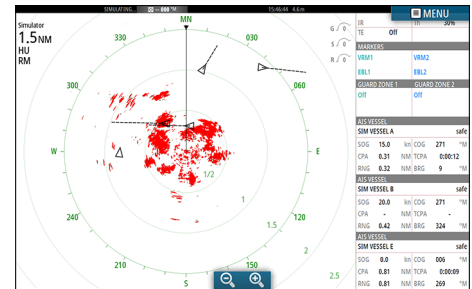

AIS vessels on a radar panel

AIS target symbols

The NSS evo2 system use the AIS target symbols shown below:

Symbol	Description	
	Sleeping AIS target (not moving or at anchor).	
	Moving and safe AIS target with course extension line.	
	Dangerous AIS target, illustrated with bold line.	A target is defined as dangerous based on the CPA and TCPA settings. Refer "Defining dangerous vessels" on page 45.
	Lost AIS target.	When no signals have been received within a time limit a target will be defined as lost. The target symbol represents the last valid position of the target before the reception of data was lost.
	Selected AIS target, activated by tapping on a target symbol.	The target will return to default target symbol when the cursor is moved.

Viewing information about AIS targets

Searching for AIS items

You can search for AIS targets from any panel by using **Find** option in the Tools panel.

From a chart panel you can search for AIS targets by using the **Find** option in the menu. If the cursor is active, the system will search for vessels around cursor position. Without an active cursor the system will search for vessels around your vessel's position.

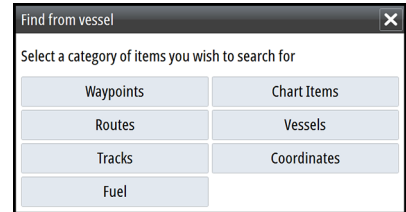

Viewing information about single AIS targets

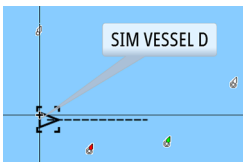

When you tap an AIS icon on the chart or radar panel the symbol will change to Selected target symbol, and the vessel name will be displayed.

You can display detailed information for a target by tapping the AIS pop-up, or from the menu when the target is selected.



AIS information on radar panels

AIS VESSEL				
SIM VESSEL A safe				
SOG	15.0	km	COG	271 °M
CPA	0.31	NM	TCPA	0:00:12
RNG	0.32	NM	BRG	9 °M
AIS VESSEL				
SIM VESSEL B safe				
SOG	20.0	km	COG	271 °M
CPA	-	NM	TCPA	-
RNG	0.42	NM	BRG	324 °M
AIS VESSEL				
SIM VESSEL E safe				
SOG	0.0	km	COG	006 °M
CPA	0.81	NM	TCPA	0:00:09
RNG	0.81	NM	BRG	269 °M

The radar data bar includes information on up to 3 AIS targets.

The targets are listed with the closest target on top, and are color coded to indicate target status.

AIS SART

When an AIS SART (Search And Rescue beacon) is activated, it starts transmitting its position and identification data. This data is received by your AIS device.

If your AIS receiver is not compliant with AIS SART, it interprets the received AIS SART data as a signal from a standard AIS transmitter. An icon is positioned on the chart, but this icon is an AIS vessel icon.

If your AIS receiver is compliant with AIS SART, the following take place when AIS SART data is received:

- An AIS SART icon is located on the chart in the position received from the AIS SART
 - An alarm message is displayed
- If you have enabled the siren, the alarm message will be followed by an audible alarm.

→ **Note:** The icon will be green if the received AIS SART data is a test and not an active message.



The following section describes the options available when an AIS SART message is received by a Navico NAIS-400 transponder.

AIS SART alarm message

When data is received from an AIS SART, an alarm message is displayed on the NSS evo2. This message includes the AIS SART's unique MMSI number, its position and its distance and bearing from your vessel. You have three options:

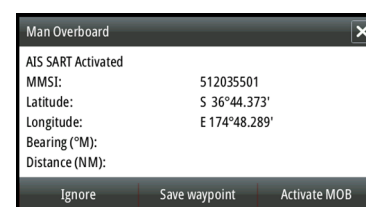

1. Ignore the alarm
 - The alarm is muted and the message closed. The alarm will not reappear
- **Note:** If you ignore the alarm, the AIS SART icon remains visible on your chart, and the AIS SART remains in the Vessels list.
- If the AIS stops receiving the AIS SART message, the AIS SART remains in the Vessels list for 10 minutes after it receives the last signal.
2. Save the waypoint
 - The waypoint is saved to your waypoint list. This waypoint name will be prefixed with MOB AIS SART - followed by the unique MMSI number of the SART. e.g. MOB AIS SART - 12345678.
 3. Activate the MOB function
 - The display switches to a zoomed chart panel, centered on the AIS SART position
 - The NSS evo2 creates an active route to the AIS SART position
- **Note:** If the MOB function is already active, this will be terminated and replaced by the new route towards the AIS SART position!
- If you tap the AIS SART icon on the chart you will see the AIS MOB details.

Vessel alarms

You can define several alarms to alert you if a target shows up within predefined range limits, or if a previously identified target is lost.

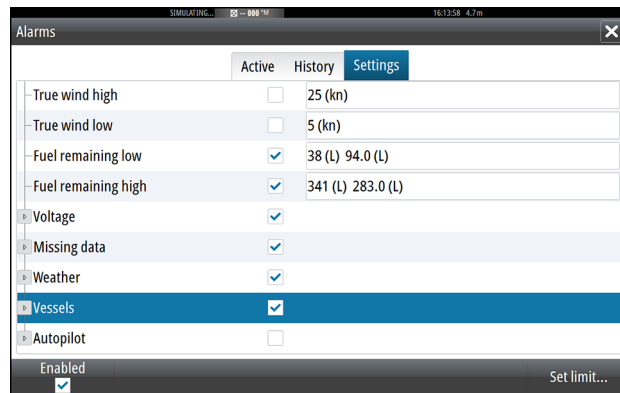

Alarm ID	Description
Dangerous vessel	Controls whether an alarm shall be activated when a vessel comes within the predefined CPA or TCPA. See “Defining dangerous vessels” on page 45.
AIS vessel lost	Sets the range for lost vessels. If a vessel is lost within the set range this will trigger an alarm → <i>Note:</i> The check box controls whether the alarm pop-up box is displayed and if the siren will sound. The CPA and TCPA defines when a vessel is dangerous regardless of the enabled/disabled state.
Vessel message	Controls whether an alarm shall be activated when a message is received from an AIS target

Vessel settings

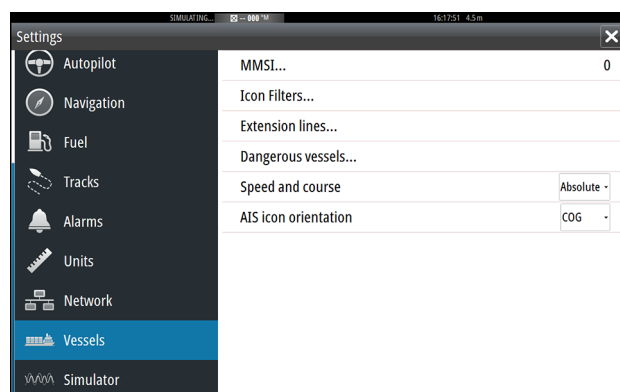

Your vessel's MMSI number

You need to have your own MMSI (Maritime Mobile Service Identity) number entered in the NSS evo2 system to be able to receive addressed messages from AIS and DSC vessels.

It is also important to have the MMSI number entered to avoid seeing your own vessel as an AIS target on the chart.

- **Note:** The Vessel message option in the alarm settings must be toggled on if any MMSI message shall be displayed.

Icon filters

All targets are by default shown on the panel if an AIS device is connected to the NSS evo2 system.

You can select not to show any targets, or to filter the icons based on security settings, distance and vessel speed.

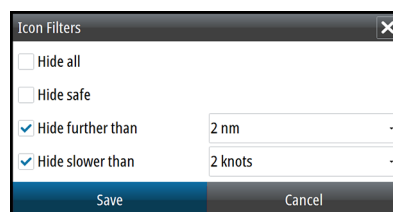

Extension lines

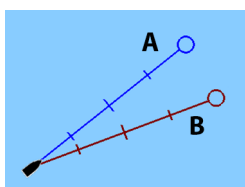

The length of the extension lines for your vessel and for other vessels can be set by the user.

- A: Heading
- B: Course Over Ground (COG)

The length of the extension lines is either set as a fixed distance, or to indicate the distance the vessel will move in the selected time period. If no options are ticked on for **This vessel** then no extension lines will be shown for your vessel.

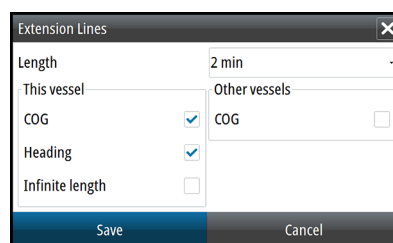

For own vessel heading information is read from active heading sensor, and COG information is as received from the active GPS.

For other vessels COG data is included in the message received from the AIS system.

Defining dangerous vessels

You can define an invisible guard zone around your vessel. When a target comes within this distance from your vessel, the symbol will change to the "dangerous" target symbol. An alarm will be triggered if activated in the Alarm settings panel.

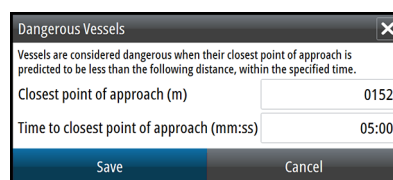

Speed and course indication

The extension line can be used to indicate speed and course for targets; either as absolute (true) motion in the chart or relative to your vessel.

Different line style is used on the extension lines to indicate motion as shown below.



AIS vessels shown with Absolute motion



AIS vessels shown with Relative motion

AIS icon orientation

Sets the orientation of the AIS icon; either based on heading or COG information.

12

Instrument panels

The instrument panels consists of multiple gauges - analog, digital and bar - that can be customized to display selected data. The instrument panel displays data on dashboards, and you can define up to ten dashboards within the instrument panel.

→ **Note:** To include fuel/engine information, engine and tank information has to be configured from the Settings panel.

Dashboards

Three dashboard layouts are predefined to display gauges showing information about vessel, navigation information and angler requirement.

You switch between a panel's dashboards by tapping the left and right side of the panel, or by selecting the dashboard from the menu.

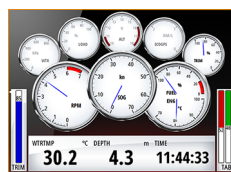

Vessel dashboard

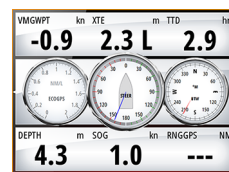

Navigation dashboard

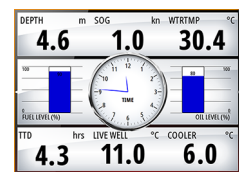

Angler dashboard

→ **Note:** Additional dashboards can be activated from the menu if other systems (i.e. CZone or Mercury) are present on the network.

Customizing the Instrument panel

You can customize the Instrument panel by changing the data for each of the gauges in the dashboard, by changing the dashboard layout, and by adding new dashboards. You can also set limits of analog gauges.

All edit options are available from the Instrument panel menu.

Available editing options will depend on which data sources that are connected to your system.

Edit a dashboard

Activate the dashboard you want to edit, then;

1. Activate the menu
2. Select the edit option
3. Tap the gauge you want to change. Selected gauge is indicated with a blue background
4. Select information to be display, limits and eventually change the source for the information
5. Save your changes by selecting the save option in the menu

13

Audio

If a SonicHub server or a FUSION marine entertainment system is connected to the NMEA 2000 network, you can use the NSS evo2 to control and customize the audio solution on your vessel.

When connected to a WM-2 or WM-3 Satellite module you can subscribe and include Sirius™ audio on your NSS evo2system. You can also connect a Sirius radio via a FUSION system. Sirius™ audio and weather service covers inland US waters and coastal areas into the Atlantic and Pacific oceans, Gulf of Mexico and the Caribbean Sea. The Sirius™ audio products received vary depending on your selected subscription package. For more information refer to www.sirius.com.

Before you can start using your audio equipment, it must be installed according to the NSS evo2 Installation manual and the documentation included with the audio device.

Enabling audio

Compatible audio device connected to the NMEA 2000 network should automatically be identified by the NSS evo2. If not, enable the feature from the **Advanced Settings** dialog.

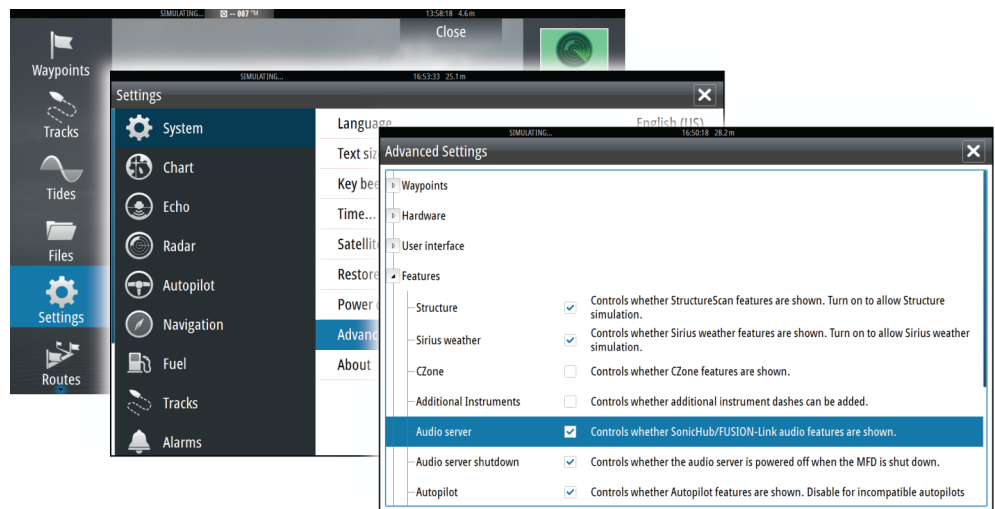

The Audio panel

You activate the audio panel by tapping the audio tile in the Instrument bar.

The control buttons, tools and options vary from one audio source to another as described later in this chapter.









Key	Description
1	Audio source
2	Audio control buttons
3	Audio tile
4	Audio tools

Audio control buttons

Icon	Tuner	VHF	DVD	Playback
	Tap to display the list of available sources			
	Tap to select previous/next frequency Press and hold to tune in a channel		Tap to rewind/ play fast forward	Tap to select previous/next track
	Tap to select next/previous favourite channel		N/A	N/A
	N/A	N/A	Tap to start	
	N/A	N/A	Tap to pause playback	
	Tap to display the volume slider			

Audio tools

Icon	Tuner	VHF	Playback
	Signal strength	N/A	N/A
	N/A	N/A	Tap to toggle on/off repeat function. The icon is colored when the function is active.
	N/A	N/A	Tap to toggle on/off shuffle mode. The icon is colored when the function is active.
	Tap to display menus used for settings up zones and master control		
	Tap to display the favourite stations for the tuner	Tap to display the favourite channels for the VHF	Tap to display the native menu for active source
	Tap to display optional settings for active source		

Setting up the audio system

The speakers

Speaker zones

The NSS evo2 can be set up to control different audio zones. Number of zones depends on the audio server connected to your NSS evo2 system.

You can adjust balance, volume and volume limit settings individually for each zone. Adjustments to the bass and treble settings will alter all zones.

Master volume control

By default the volume for all speaker zones are adjusted when you adjust the volume on an NSS evo2 unit. You can define which zones shall be altered when you increase/decrease the volume from the NSS evo2 unit.

Selecting tuner region

Before playing FM or AM radio and before using a VHF radio you must select the appropriate region for your location.

Detaching Sirius from the AUX source

If a Sirius radio is connected to the FUSION radio/server, the AUX source will be automatically attached to the Sirius feed. **Sirius** will then appear in the source list when the FUSION server is active.

To use the AUX source for a different device, the Sirius must be detached from the AUX source.

→ *Note:* To use SiriusXM an optional SiriusXM tuner must be connected to the FUSION server.

Operating the audio system

1. Tap the Audio tile in the Instrument bar to activate the Audio overlay
2. Tap the options icon and select the audio server
3. Tap the source icon to select the audio source
 - Number of sources depends on active audio server
4. Use the panel buttons to control your audio system.

Refer to the overview of audio control buttons and tools previously in this chapter.

For available options and features for the audio equipment, refer to the documentation following the audio equipment.

Favourite channels

When a tuner or VHF channel is tuned in, you can add the channel to your favourite list. The favourite channels can be viewed, selected and deleted from within the Favourite list.

You page through favourite channels by using the up/down audio panel buttons.

Using Sirius radio (North America only)

Channels list

The channels list displays all available Sirius channels, whether or not you have a subscription for the channel.

Favorite list

You can create a list of your favorite Sirius channels from within the channels list. You will not be able to add unsubscribed channels.

Locking channels

You can lock selected Sirius channels from being broadcasted unless an unlock code is entered.

When the function is activated, a 4 digit code must be entered before the locking is activated.

The same code must be entered before a locked channel can be released.

14

Weather

GRIB weather

The NSS evo2 includes a GRIB data viewer. You can import weather data in GRIB format via an SD card inserted into the card reader, and overlay the information onto your charts. Weather data in GRIB format is available for download from various web sites.

Importing GRIB data

GRIB data must be imported into memory before it can be used. The file can be imported from any location that can be seen in the file explorer.

→ **Note:** GRIB data that is imported from an SD card will not be saved in the NSS evo2. The data will be lost when new GRIB data is imported.

Select the GRIB file to import the data.

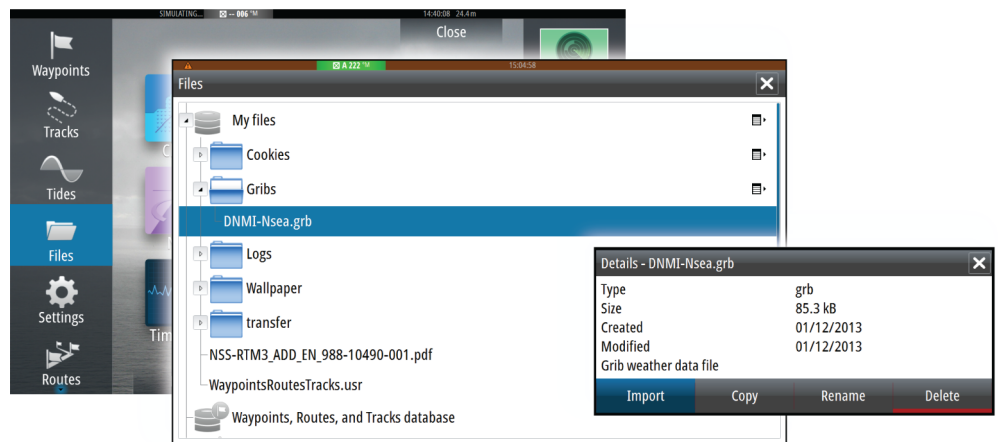

The GRIB weather display

Imported GRIB weather data can be displayed as an overlay on your chart panel.

When the GRIB weather overlay is selected, the chart menu will increase to show GRIB weather options. From this menu you can select which weather symbols you want to display, set the distance between the barbs, and you can adjust the opaqueness of the weather symbols.

From this menu you can also animate the weather forecast as described later in this chapter.

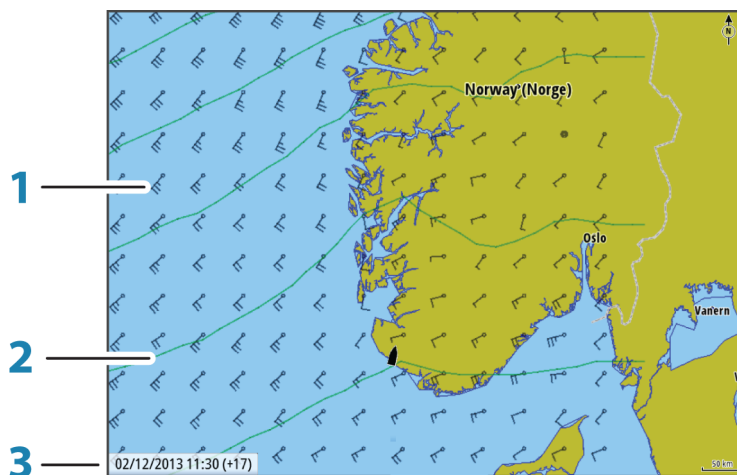





Key	Description
1	Wind barbs
2	Pressure contours
3	GRIB information window

Wind barbs

The rotation of the wind barbs indicate the relative wind direction, with the tail showing the direction the wind is coming from. In the graphics below the wind comes from northwest.

Wind speed is indicated by a combination of small and large barbs at the end of the wind tail.

	Zero knots / Indeterminate wind direction
	Small barb = 5 knots
	Large barb = 10 knots
	Arrow barb = 50 knots

If a combination of 5 and 10 knot barbs are shown on a tail then these will need to be added together to give you the total wind speed. The example below shows 3 x large barb + 1 x small barb = 35 knots, and 60 knots indicated with 1 x arrow barb + 1 x large barb.



Wind speed: 35 knots



Wind speed: 60 knots

GRIB information window

The GRIB information window shows the date and time for the GRIB weather forecast, and the selected forecast time in brackets. A negative value in the brackets indicates historic weather data.

If you tap a position on the chart the information window will expand to include weather details for the selected position.

Animating GRIB weather forecast

The GRIB data contains forecast information for a set number of days. It is possible to animate the weather data and to show the predicted forecast for a specific time and date. The time scales will vary depending on the file you are using.

The time shift is shown in brackets in the GRIB information window. The time will be relative to the current time as provided by a GPS device connected to the NSS evo2.

Select time and animation speed from the menu.

SiriusXM™ weather

When connected to a Navico Weather module, you can subscribe and include Sirius™ audio and Sirius™ Marine Weather Service on your NSS evo2 system (North America only).

Sirius™ audio and weather service covers inland US waters and coastal areas into the Atlantic and Pacific oceans, Gulf of Mexico and the Caribbean Sea.

The audio and weather products received vary depending on your selected subscription package. For more information refer to www.siriusxm.com/marineweather

Sirius status panel

When the weather module is connected to the system, you will get access to the Sirius™ status panel.

Signal strength is indicated as 1/3 (weak), 2/3 (good) or 3/3 (preferred).

The ESN shows the electronic serial number for the WM-2 module.

Sirius weather display

The Sirius weather can be displayed as an overlay on your chart panel.

When weather overlay is selected, the chart menu will increase to show the available weather options.

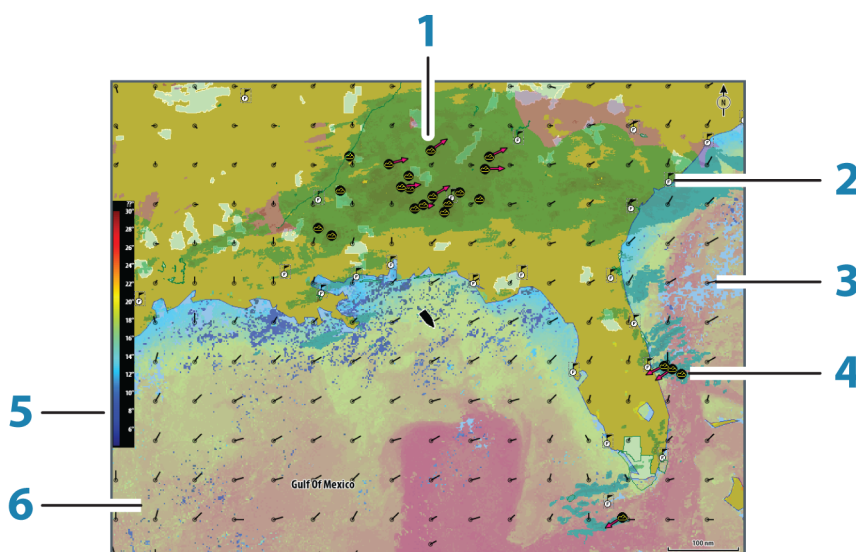

Key	Description
1	Precipitation color shading
2	City forecast icon
3	Wind barb
4	Storm icon
5	SST color bar
6	SST color shading

Use the Sirius weather option menu to select which weather symbology that should be displayed and how they should appear on the chart panel.

Precipitation

Shades of color are used to show precipitation type and intensity. Darkest color indicates highest intensity.

Precipitation type	Color code
Rain	From light green (light rain) - yellow - orange - to dark red (heavy rain)
Snow	Blue
Mixed	Pink

Sea Surface Temperature (SST)

Can be shown as color shading or text.

When color coding is selected, the SST color bar will be shown on the left side of the display. You can define which temperature range that shall be color coded as described later in this section.

Wave indication





Colors are used to indicate forecasted wave height. Dark red indicate the highest waves, while blue are used for the lowest.

You can define which height range shall be color coded as described later in this section.

Wind barbs

The rotation of the wind barbs indicate the relative wind direction, with the tail showing the direction the wind is coming from. In the graphics below the wind comes from northwest.

Wind speed is indicated by a combination of small and large barbs at the end of the wind tail.





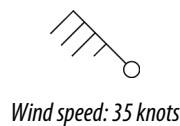



	Zero knots / Indeterminate wind direction
	Small barb = 5 knots
	Large barb = 10 knots
	Arrow barb = 50 knots

If a combination of 5 and 10 knot barbs are shown on a tail then these will need to be added together to give you the total wind speed. The example below shows 3 x large barb + 1 x small barb = 35 knots, and 60 knots indicated with 1 x arrow barb + 1 x large barb.



Weather icons

Several weather icons are available to show current or predicted weather conditions. You can tap an icon to display detailed weather information.

Icon	Description
	City forecast
	Surface observation
	Tropical storm tracking; past (grey) - present (red) - future (yellow)
	Hurricane (category 1-5) tracking; past (grey) - present (red) - future (yellow)
	Tropical disturbance/depression tracking; past (grey) - present (red) - future (yellow)
	Storm attributes
	Lightning
	Watch box location and warning
	Marine zone location

Color Shading

You can define the sea surface temperature range and wave height color coding.

The temperature above warm and below cool values will be displayed as progressively darker red and darker blue.

Waves higher than the maximum value will be indicated with progressively darker red. Waves lower than the minimum value will not be color coded.

Marine zones

Sirius™ service includes access to weather reports for all U.S. Marine Zones, with the exception of the high seas zones.

You can setup the system to read the forecast for a selected area.

Tap the selected zone, and use the menu to confirm your selection.

Tropical statements

You can read tropical statements including information about tropical weather conditions. These statements are available for the entire Atlantic and the Eastern Pacific.

Showing Sirius weather details

When you tap a shaded weather area, available information will be shown in the cursor window.

If pop-up is enabled, you can tap an weather icon to display the identity of the observation. If you tap the pop-up detailed information about the observation is displayed. You can also display the detailed information from the menu when the icon is selected.

Animating Sirius™ weather graphics

The NSS evo2 records the weather information you have turned on, and this information can be used to animate past or future weather conditions. The amount of information available in the system depends on the amount of weather activity; the more complex it is, the less time will be available for animation.

You can animate the past or the future, depending on which weather view you have turned on:

- if the precipitation overlay was turned on, you can animate for the past and only assume weather conditions in the immediate future.
- if the colored wave height overlay was turned on, you can animate the future (the predictions).

When activated, the time for the current graphic animation will be displayed in the lower left corner of the chart panel.

Weather alarms

You can setup the lightning or storm alarms to be within a certain range of your vessel.

You can also get an alarm as a severe weather forecast alarm issued for your chosen marine zone.

A watchbox is defined by the National Weather Service. When the alarm is turned on you will get an alarm when your vessel is inside or is entering into a watchbox.

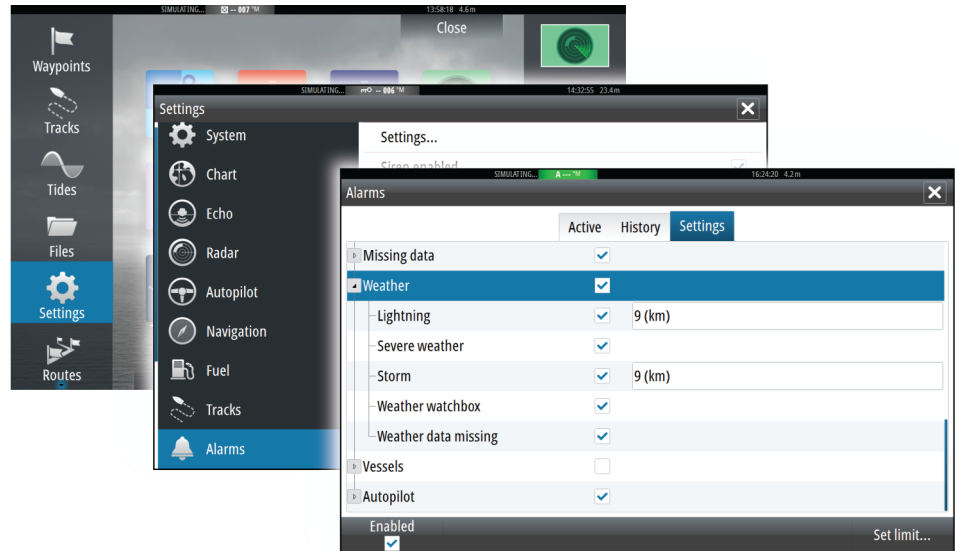

15

Video

The video function allows you to view videos or camera sources on your NSS evo2.

→ **Note:** The video images will not be shared via the network. You can only view the video on the unit connected to the video source.

If a FLIR camera is available on the Ethernet network, you can display the video and control the camera from the NSS evo2.

For information about how to connect the camera, see the separate NSS evo2 Installation manual.

The Video panel

A video panel can be set up as a single panel, or as one of the panels on a multiple panel page.

The video image will be proportionally scaled to fit into the video panel. Area not covered by the image will be colored black.

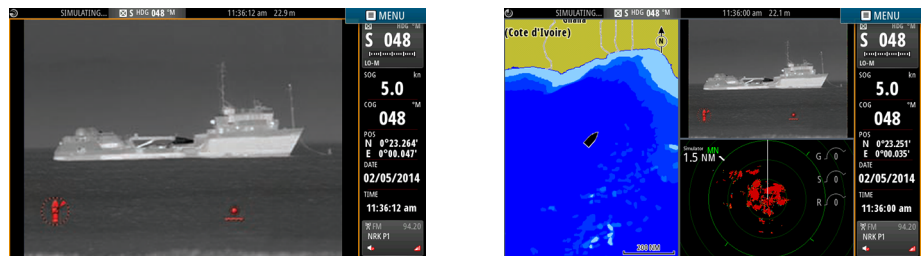

Setting up the video panel

Video source

NSS evo2 supports two video input channels. You can select to view one channel only, or to cycle the image between available video cameras.

The cycle period can be set from 5 to 120 seconds.

Video standard

NSS evo2 supports NTSC and PAL video. The two channels are set up individually. Check the local video standard or the standard of your cameras.

Adjusting the video image

You can optimize the video display by adjusting the video image settings. The settings are adjusted individually for each video source. Default for all settings: 50%.

FLIR camera control

When the connection is established to a FLIR camera, the menu will change to include access to FLIR camera controls.

→ **Note:** You can take over camera control from any NSS evo2 connected to the Ethernet network.

Establishing connection with the FLIR video camera

When a video panel is active, the NSS evo2 will automatically recognize a Flir camera if this is available on the network.

→ **Note:** When there is DHCP server present on the Ethernet network, FLIR camera will need to be configured and set to have Static IP Address before the connection can be established. For instructions on how to configure your specific FLIR camera model please refer to FLIR documentation.

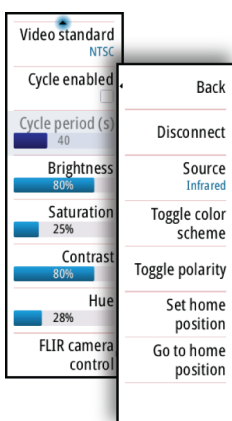

→ **Note:** Only one FLIR camera can be connected to the Ethernet network at a time.

When you activate a video panel, the system will start searching the network for a FLIR camera.

If the connection later is lost, this will be indicated by a panel key. Tap this key to reestablish the connection.

When the connection is established the menu will change to include access to FLIR camera control.

→ **Note:** You can take over camera control from any NSS evo2 unit connected to the Ethernet network.

Panning and tilting the FLIR camera

When the connection to the FLIR camera is established, pan and tilt panel buttons appear on the video panel. The left and right arrow buttons control the camera's pan, while the up and down arrow buttons tilt the camera.

Press one of the arrow buttons on the panel to control the camera. The camera will move as long as you press the button.

Zooming the FLIR video image

You zoom the video image by using the zoom panel buttons.

There are two different zoom options available, depending on selected FLIR camera source option.

Digital zoom

Only available when the camera is in Infrared mode.

In this mode the zoom is represented in levels (0, 2 and 4 times zoom). Each press on a zoom button will increment or decrement the zoom level.

Optical zoom

Available in daylight mode.

In this mode the camera will zoom as long as you press a zoom panel button.

The FLIR camera source options

The FLIR camera includes both daylight and infrared video sources.

When the infrared source is selected, the following options are available:

Toggle color scheme	Cycles through FLIR's video output color scheme. Each of these schemes maps a different color to a different temperature
Toggle polarity	Inverts the color scheme. For example, instead of: White = Hot and Black = Cold, it will become Black = Hot and White = Cold

The FLIR camera's home position

You can set the current pan and tilt position as the camera's home position.

You can later quickly return to this camera position.

16

Time plots

The NSS evo2 can present data history in different plots. The plots can be displayed in full page, or combined with other panels.

You can select which data to present, and you can define the time range for each plot.

The Time plot panel

The Time plot panel consists of two predefined layouts. You switch between the layouts by tapping the left and right panel arrows or by selecting the layout from the menu.

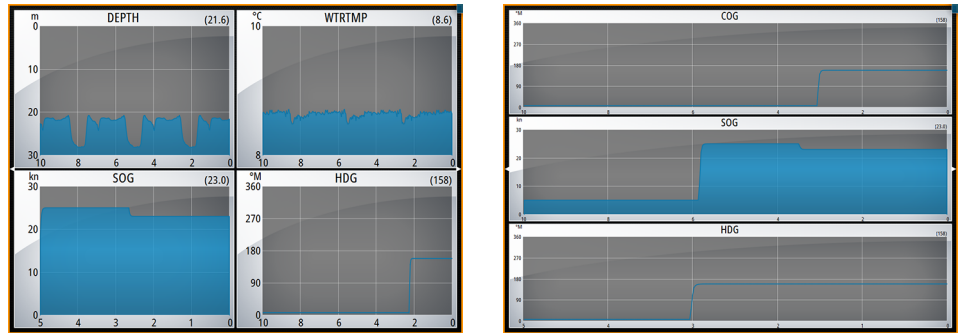

Layout 1

Layout 2

Missing data

If the data is unavailable, the relevant plot will turn into a dashed line and flatten out at the point the data was lost. When the data becomes available again a dashed line will join up the two points showing an average trend line bridging the missing data.

Selecting data

Each data field can be changed to show the preferred data type and the time range.

1. Select the edit option from the menu
2. Activate the field for which you want to edit the data
3. Change the information type and eventually the range
4. Save your changes

The data available for the Time plots are by default the sources used by the system. If more than one data source is available for a data type you can select to show alternative data source in the Time plot. You change the data type by using the data source option in the menu.

17

Alarms

Alarm system

The system will continuously check for dangerous situations and system faults while the system is running. When an alarm situation occurs, an alarm message pops up on the screen. An alarm icon is displayed in the status bar, and the status bar pulses the color of the alarm.

If you have enabled the siren, the alarm message will be followed by an audible alarm, and the switch for external alarm will go active.

The alarm is recorded in the alarm listing so that you can see the details and take the appropriate corrective action.

Type of messages

The messages are classified according to how the reported situation will affect your vessel. The following color codes are used:

Color	Importance
Red	Critical
Orange	Important
Yellow	Standard
Blue	Warning
Green	Light warning

Single alarms

A single alarm is displayed with the name of the alarm as the title, and with details for the alarm.

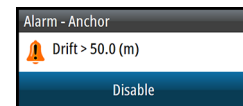

Multiple alarms

If more than one alarm is activated simultaneously, the alarm message will display a list of up to 3 alarms. The alarms are listed in the order they occur with the alarm activated first at the top. The remaining alarms are available in the Alarms dialog.

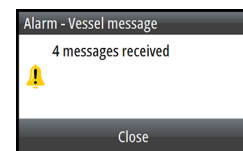
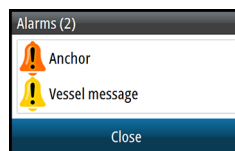

Acknowledging a message

The following options are available in the alarm dialog for acknowledging a message:

Option	Result
Close	Sets the alarm state to acknowledged, meaning that you are aware of the alarm condition. The siren / buzzer will stop and the alarm dialog will be removed. The alarm will however remain active in the alarm listing until the reason for the alarm has been removed.
Disable	Disables the current alarm setting. The alarm will not show again unless you turn it back on in the Alarms dialog.

There is no time-out on the alarm message or siren. They remain until you acknowledge the alarm or until the reason for the alarm is removed.

Alarms dialog

All alarms are setup in the Alarms Settings dialog.

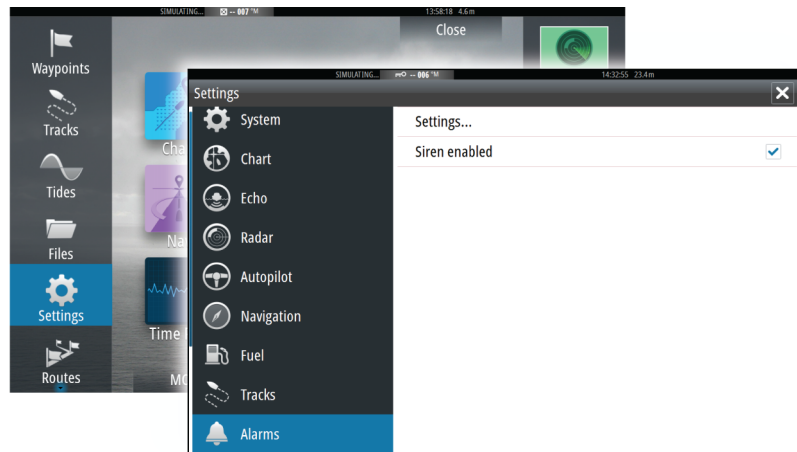

The alarm dialogs can also be activated from the Tools panel.

The alarm dialogs includes information about active alarms and alarm history.

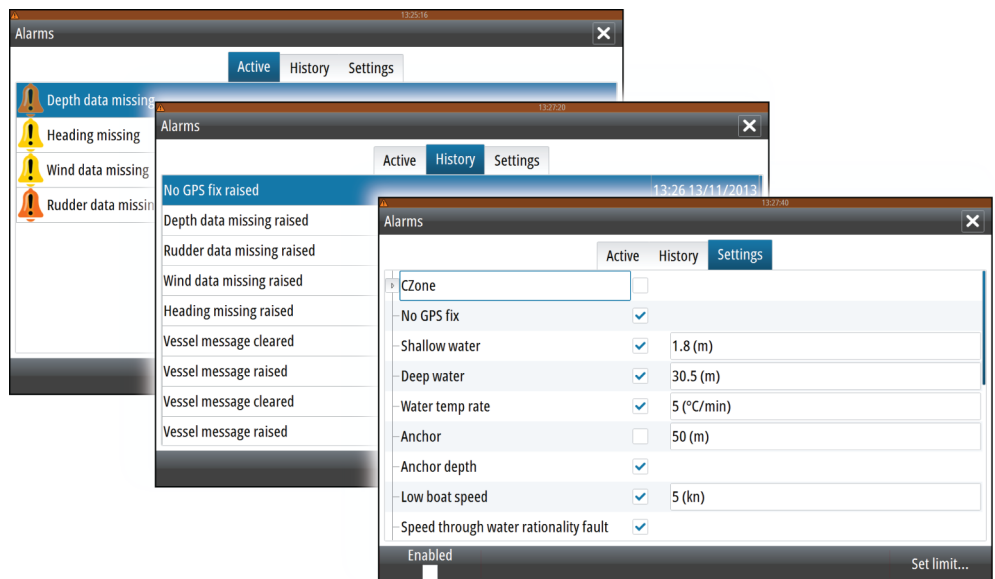

18

Tools

The Tools panel includes access to options and tools that are not specific to any panel.

Waypoints/routes/tracks

List of waypoints, routes and tracks with details.

Tap on the waypoint, route or track you wish to edit or delete

Tides

Displays tide information for the tide station nearest to your vessel.

Tap the arrow panel buttons to change date, or tap the date field to access the calendar function.

Available tide stations can be selected from the menu.

Alarms

Active alarms

List of active alarms.

Alarm history

List of all alarms with time stamp.

Alarm settings

List of all available alarm options in the system, with current settings.

Settings

Provides access to application and system setting.

Vessels

Status listing

List of all AIS, MARPA, and DSC vessels with available information.

Message listing

List of all messages received from other AIS vessels with time stamp.

Sun/moon

Displays sunrise, sunset, moonrise and moonset for a position based on entered date and the position's latitude/longitude.

Trip calculator

Trip 1 / Trip 2

Displays voyage and engine information, with reset option for all data fields.

Today

Displays voyage and engine information for current date. All data fields will be automatically reset when the date changes.

Files

File management system for files, waypoints, routes, tracks and settings.

Find

Search function for several chart items.

19

Simulator

About the simulator

The simulation feature lets you see how the unit works in a stationary position and without being connected to echosounder, radar, GPS etc.

Use the simulator to help you become familiar with your unit before using it out on the water.

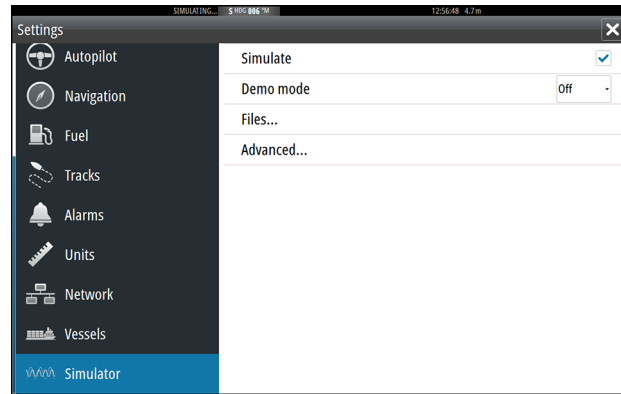

When the simulator is toggled on this is indicated in the status bar.

Demo mode

In this mode the unit automatically runs through the main features of the product; it changes pages automatically, adjusts settings, opens menus etc.

If you tap the screen or press a key when demo mode is running, the demonstration will pause. After a time-out period, demo mode will resume.

Selecting simulator source files

You can select which data files to be used by the simulator.

A set of source files is included in your system, and you can import files by using an SD card inserted into the unit's card reader.

You can also use your own recorded echosounder files in the simulator.

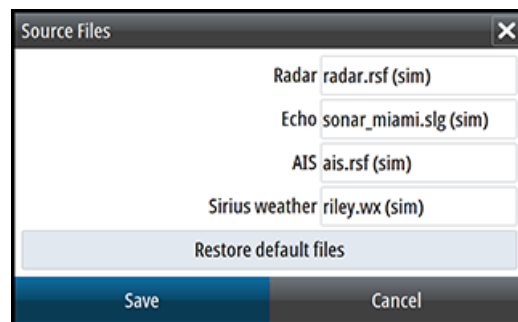

Advanced simulator settings

The advanced simulator settings allow you to define how to run the simulator. When the settings are saved these will be used as default when starting the simulator mode.

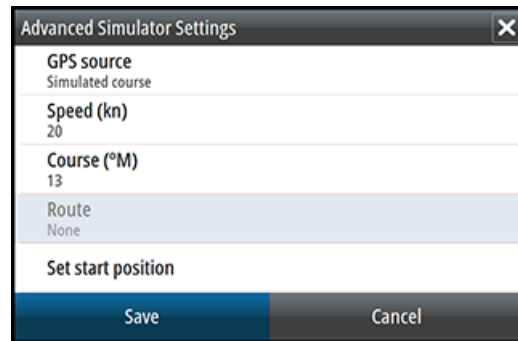

GPS source

Selects where the GPS data is generated from.

Speed, Course and Route

Used for manually entering values when GPS source is set to Simulated course or Simulated route. Otherwise, GPS data including speed and course comes from the selected echosounder or radar files.

Set start position

Moves the vessel to current cursor position.

→ *Note:* This option is only available when the GPS source is set to Simulated course.

20

Maintenance

Preventive maintenance

The NSS evo2 unit does not contain any field serviceable components, therefore the operator is required to perform only a very limited amount of preventative maintenance.

It is recommended that you always fit the supplied protective sun cover when the unit is not in use.

Cleaning the display unit

The supplied cleaning cloth should be used to clean the screen, where possible. Use plenty of water to dissolve and take away salt remains. Crystallized salt may scratch the coating if using a damp cloth. Apply minimal pressure to the screen.

Where marks on the screen can't be removed by the cloth alone, use a 50/50 mixture of warm water and isopropyl alcohol to clean the screen. Avoid any contact with solvents (acetone, mineral turpentine etc.), or ammonia based cleaning products, as they may damage the anti-glare layer or plastics bezel.

To prevent UV damage to the plastic bezel, it is recommended that the sun cover be fitted when the unit is not in use for an extended period.

Cleaning the media port door

Clean the media port door regularly to avoid that salt crystallize on the surface, causing water to leak into the card slot.

Checking the keys

Make sure that no keys are stuck in the down position. If one is stuck, wiggle the key to free it back to normal.

Checking the connectors

The connectors should be checked by visual inspection only.

Push the connector plugs into the connector, if the connector plugs are equipped with a lock; ensure that this is in the correct position.

NMEA 0183 Data logging

All serial output sentences sent over the NMEA 0183 TCP connection are logged to an internal file. You can export and review this file for service and fault finding purposes.

The maximum file size is predefined. If you have added several other files to the system (sonar and/or StructureMap recordings, music, pictures, pdf files), this may reduce the allowed file size for the log file.

The system logs as much data as possible within the file size limitation, then it starts overwriting the oldest data.

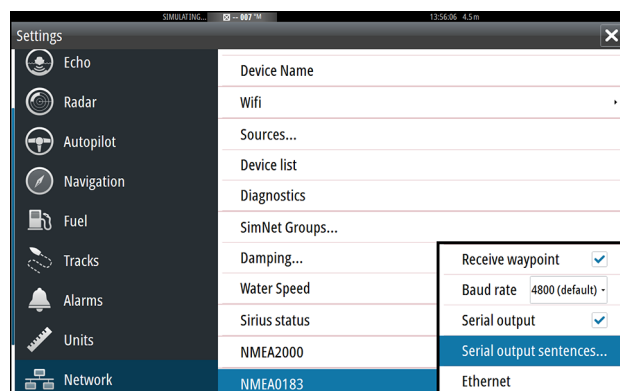

Exporting the log file

The log file can be exported from the files browser.

When you select the Log database you are prompted to select a destination folder and filename. Once accepted the log file is written to the chosen location.

Software upgrades

The latest software for the NSS evo2 will be available for download from our website; www.simrad-yaching.com

Detailed instructions for how to install the software will follow the upgrade files.

Backing up your system data

Waypoints, routes, tracks that you create are filed in your system. It is recommended to regularly copy these files and your system settings files as part of your back-up routine.

The files can be copied to an SD card inserted in the card slot on the front of the unit.

Different output formats are available:

User Data File version 5	This is used to import and export waypoints and routes with a standardized universally unique identifier (UUID), which is very reliable and easy to use. The data includes such information as the time and date when a route was created etc.
User Data File version 4	This is best used when transferring data from one NS* system to another, since it contains all the extra bits of information these systems store about items.
User Data file version 3 (w/depth)	Should be used when transferring user data from an NS* system to a legacy Lowrance (LMS, LCX, etc)
User data file version 2 (no depth)	
GPX (GPS Exchange)	This is the format most used on the web that shares among most GPS systems in the world. Use this format if you are taking data to a competitors unit.
Northstar.dat (no Tracks)	Used to transfer data to a legacy Northstar device.

The graphics shows how to export waypoints, routes and tracks.

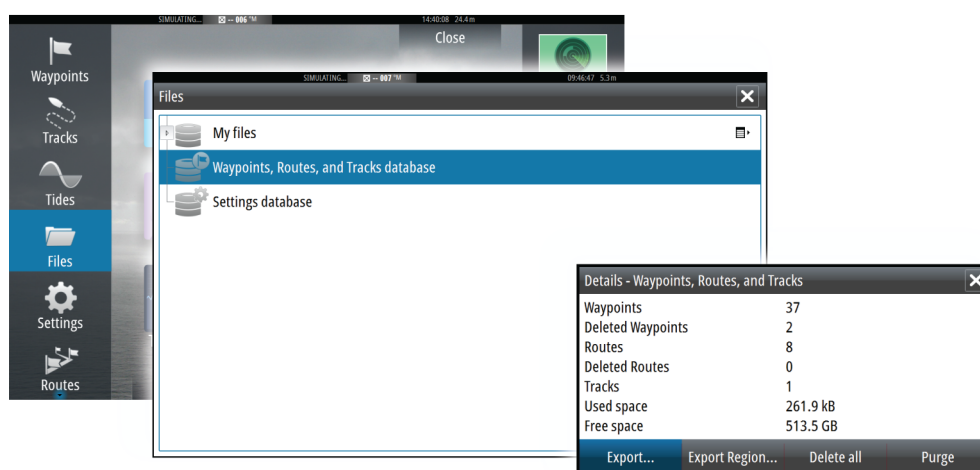

1. Select the files option from the home page
2. Select the data you want to export
3. Tap the export option in the dialog
4. Select export format
5. Select destination folder
6. Enter name for exported file.



SIMRAD