

Fitting remote

Cradle at fixed position

1. Mark holes for the fixing screws.

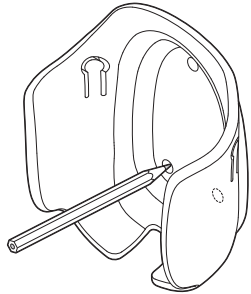

2. Drill three 1/8 inch (3.4 mm) pilot holes for the fixing screws

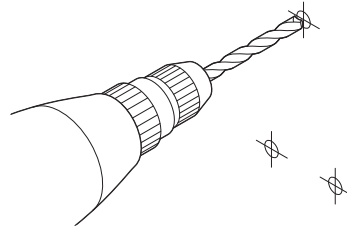

3. Countersink the pilot holes to prevent damage to the mounting surface.

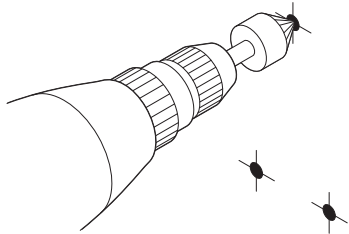

4. Use the three No. 8 screws to secure the cradle to the mounting surface

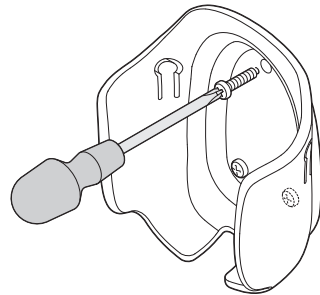

Base Station & Wireless Controller Installation guide

Parts supplied

Base Station

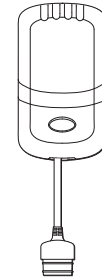

No. 6 size
No. 8 size
Self-tapping screws



S100 Remote OR

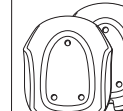

Cradles x2

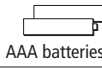

AAA batteries x2

Smart Controller

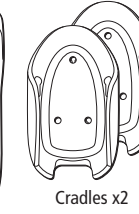

Cradles x2

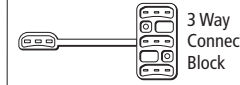

3 Way
Connector
Block

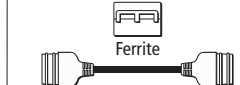

Ferrite



SeaTalk Cable

Charging Cable

Tools Required



Power Drill



Pozidriv screwdriver

1/8 inch (3.4 mm) drill

7/64 inch (2.7 mm) drill

Locating Base Station

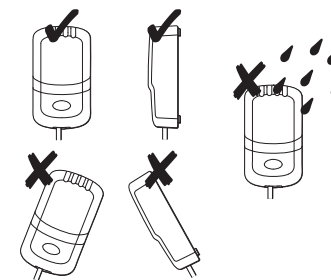

Fit as high up as possible, in a dry location

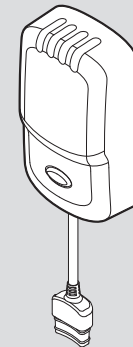
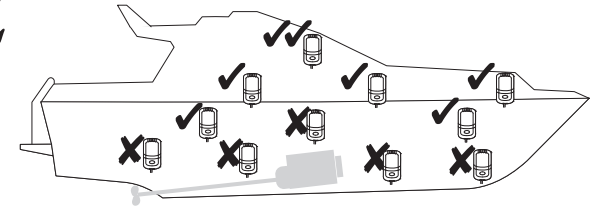

Min 3ft 3in (1m)

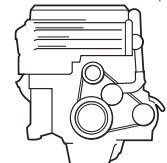
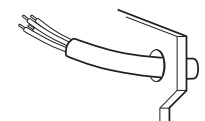
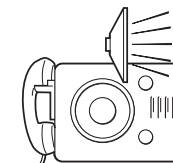
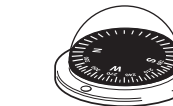

Raymarine®

Document: 87042-6

Date: 08-2020

www.raymarine.com

Fitting Base Station

1. Remove cover

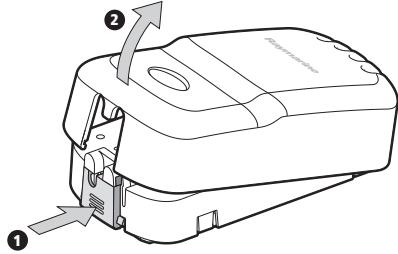

2. Mark holes for the fixing screws.

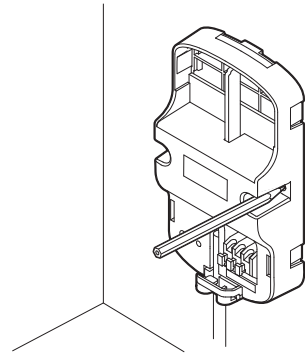

3. Drill two $\frac{7}{64}$ inch (2.7 mm) pilot holes for the fixing screws

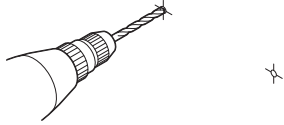

4. Countersink the pilot holes to prevent damage to the mounting surface

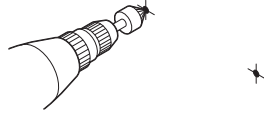

5. Use the two No. 6 screws to secure the Base Station to the mounting surface

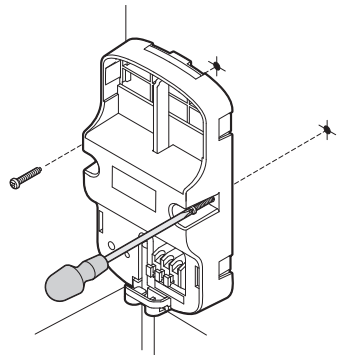

6. Replace cover

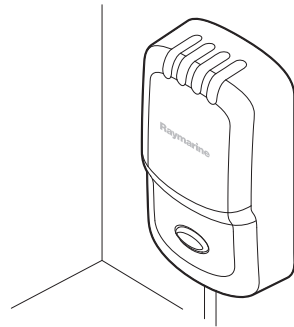

Connecting Base Station to SeaTalkng system

Important: Before connecting the Base Station, ensure that the 12 V supply on the SeaTalkng system is protected by 5 A fuse.

Provided you do not want to connect to NMEA2000, you can connect the S100 or Smart Controller to a SeaTalkng system using a suitable SeaTalkng bridging product (such as SeaTalk to STng converter, or ST70 Instrument), and a suitable SeaTalk(1) to SeaTalkng adaptor cable. If you intend doing this, please note:

- 1) If connecting via SeaTalk to STng converter, the converter must ONLY be powered by the SeaTalkng bus.
- 2) You can connect a **single** SeaTalk(1) network to SeaTalkng in the way described above;
- 3) You can connect **two** SeaTalk(1) networks to SeaTalkng in the way described above, but **the two SeaTalk(1) networks must NOT be connected together**. For more detail, refer to SeaTalkng Networking Guide (81300).

Connecting Base Station to SeaTalk system

Important:

Before connecting the Base Station, ensure that the 12 V supply on the associated SeaTalk system is protected by a 5 A fuse.

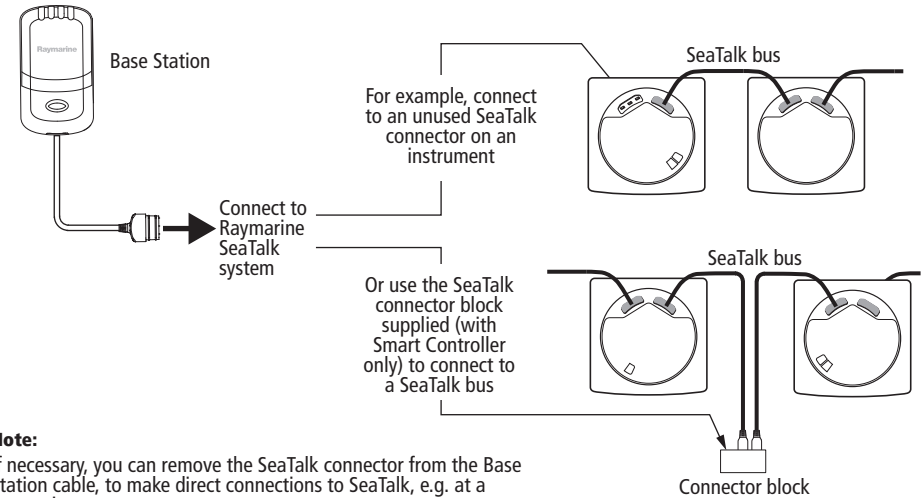

Note:

If necessary, you can remove the SeaTalk connector from the Base Station cable, to make direct connections to SeaTalk, e.g. at a Raymarine course computer.

SeaTalk color coding: Yellow: SeaTalk data; Red: +12 V; Screen: 0 V

Connecting Smart Controller charging cable

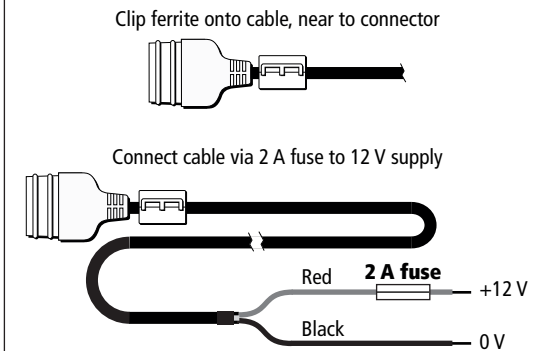

Fitting batteries to S100 Remote

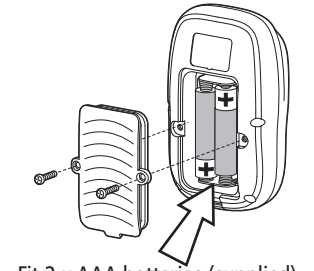

Fit 2 x AAA batteries (supplied).
When replacing, use only high-quality alkaline, AAA size batteries.

Testing wireless range

Individual installation environments have a significant impact on wireless range; each vessel is different. Move around your vessel while observing the wireless signal strength gauge. This provides an indication of the wireless range you can expect to experience when using the remote at various locations around your vessel. If you have any issues or questions about this, please contact Product Support.