



## INSTRUCTION MANUAL

VHF MARINE TRANSCEIVER

# IC-M73 IC-M73EURO

This device complies with Part 15 of the FCC Rules. Operation is subject to the condition that this device does not cause harmful interference.

**Icom Inc.**



IC-M73

IC-M73EURO

(These transceivers use the FA-S64V)

Thank you for purchasing this Icom product. The IC-M73/IC-M73EURO VHF MARINE TRANSCEIVER is designed and built with Icom's state of the art technology and craftsmanship. With proper care, this product should provide you with years of trouble-free operation.

---

## IMPORTANT

---

**READ ALL INSTRUCTIONS** carefully and completely before using the transceiver.

**SAVE THIS INSTRUCTION MANUAL** — This instruction manual contains important operating instructions for the IC-M73/IC-M73EURO.

Icom is not responsible for the destruction, damage to, or performance of any Icom or non-Icom equipment, if the malfunction is because of:

- Force majeure, including, but not limited to, fires, earthquakes, storms, floods, lightning, other natural disasters, disturbances, riots, war, or radioactive contamination.
- The use of Icom transceivers with any equipment that is not manufactured or approved by Icom.

Icom, Icom Inc. and Icom logo are registered trademarks of Icom Incorporated (Japan) in Japan, the United States, United Kingdom, Germany, France, Spain, Russia, Australia, New Zealand, and/or other countries.

---

## EXPLICIT DEFINITIONS

---

WORD	DEFINITION
⚠ <b>DANGER!</b>	Personal death, serious injury or an explosion may occur.
⚠ <b>WARNING!</b>	Personal injury, fire hazard or electric shock may occur.
<b>CAUTION</b>	Equipment damage may occur.
<b>NOTE</b>	If disregarded, inconvenience only. No risk of personal injury, fire or electric shock.

---

## PRECAUTIONS

---

**⚠ DANGER! NEVER** short the terminals of the battery pack.

**⚠ DANGER!** Use and charge only specified Icom battery packs with Icom transceivers or Icom chargers. Only Icom battery packs are tested and approved for use with Icom transceivers or charged with Icom chargers. Using third-party or counterfeit battery packs or chargers may cause smoke, fire, or cause the battery to burst.

**⚠ WARNING! NEVER** connect the transceiver to an AC outlet. This may pose a fire hazard or result in an electric shock.

**⚠ WARNING! NEVER** hold the transceiver so that the antenna is closer than 2.5 cm (1 inch) from exposed parts of the body, especially the face or eyes, while transmitting. The transceiver will perform best if the microphone is 5 to 10 cm (2 to 4 inches) away from the lips and the transceiver is vertical.

**CAUTION: NEVER** connect the transceiver to a power source other than the products specified by Icom. Such a connection will ruin the transceiver.

**CAUTION: MAKE SURE** the flexible antenna and battery pack are securely attached to the transceiver, and that the antenna and battery pack are dry before attachment. Exposing the inside of the transceiver to water will result in serious damage to the transceiver.

**BE CAREFUL!** The transceiver meets IPX8 requirements for waterproof protection. However, once the transceiver has been dropped, waterproof protection cannot be guaranteed because of possible damage to the transceiver's case or the waterproof seal.

**NEVER** place the transceiver in an insecure place to avoid inadvertent use by unauthorized persons.

**DO NOT** use or place the transceiver in direct sunlight or in areas with temperatures below  $-20^{\circ}\text{C}$  ( $-4^{\circ}\text{F}$ ) or above  $+60^{\circ}\text{C}$  ( $+140^{\circ}\text{F}$ ) for the EXP/USA versions, below  $-15^{\circ}\text{C}$  ( $+5^{\circ}\text{F}$ ) or above  $+55^{\circ}\text{C}$  ( $+131^{\circ}\text{F}$ ) for the CHN/EUR/FRG/HOL/UK versions, and below  $-10^{\circ}\text{C}$  ( $+14^{\circ}\text{F}$ ) or above  $+55^{\circ}\text{C}$  ( $+131^{\circ}\text{F}$ ) for the AUS versions.

**DO NOT** use harsh solvents such as benzene or alcohol when cleaning, as they will damage the transceiver surfaces.

**DO NOT** push [PTT] when not actually intending to transmit.

**DO NOT** modify the transceiver. The transceiver warranty does not cover any problems caused by unauthorized modification.

**DO NOT** operate the transceiver near unshielded electrical blasting caps or in an explosive atmosphere.

**KEEP** the transceiver out of the reach of children.

**KEEP** the transceiver at least 0.9 meter (3.0 feet) away from your vessel's magnetic navigation compass.

---

# PRÉCAUTIONS

---

**⚠ DANGER ! NE JAMAIS** court-circuiter les bornes du bloc-batterie.

**⚠ DANGER !** Utiliser et charger exclusivement les packs batteries Icom spécifiés avec des émetteurs-récepteurs Icom ou un chargeurs Icom. Seuls les packs batteries Icom ont été testés et homologues pour l'utilisation avec des émetteurs-récepteurs ou des chargeurs Icom. L'utilisation de packs batterie ou de chargeurs tiers ou de contrefaçon peut être à l'origine de fumées, d'incendie ou faire éclater la batterie.

**⚠ AVERTISSEMENT ! NE JAMAIS** brancher l'émetteur-récepteur directement à une prise secteur. Cela risquerait de provoquer un incendie ou un choc électrique.

**⚠ AVERTISSEMENT ! NE JAMAIS** rapprocher l'émetteur-récepteur à moins de 2,5 cm (1 pouce) des parties exposées du corps, particulièrement le visage et les yeux, en cours émission. Les performances de l'émetteur-récepteur sont optimales quand le microphone est tenu entre 5 et 10 cm (2 et 4 pouces) de la bouche de l'utilisateur et quand l'émetteur-récepteur est vertical.

**MISE EN GARDE : NE JAMAIS** brancher l'émetteur-récepteur à une source d'alimentation autre que celle des produits recommandés par Icom. Cela pourrait endommager l'émetteur-récepteur.

**MISE EN GARDE : VEILLER** à fixer et à connecter correctement l'antenne souple et le pack batterie à l'émetteur-récepteur. Vérifier qu'ils sont absolument secs avant de les connecter. L'infiltration d'eau à l'intérieur de l'émetteur-récepteur peut entraîner des dommages irréversibles.

**MISE EN GARDE !** L'émetteur-récepteur est conforme aux exigences IPX8 en matière d'étanchéité. Toutefois, lorsque l'émetteur-récepteur a été immergé, l'étanchéité ne peut pas être garantie, en raison des risques de dommages pouvant affecter le boîtier ou le joint d'étanchéité de l'émetteur-récepteur.

**NE** placez **JAMAIS** l'appareil dans un endroit non sécurisé pour éviter toute utilisation par des personnes non autorisées.

**NE PAS** utiliser ou placer l'émetteur-récepteur en plein soleil ou dans des zones dans lesquelles les températures sont inférieures à  $-20^{\circ}\text{C}$  ( $-4^{\circ}\text{F}$ ) ou supérieures à  $+60^{\circ}\text{C}$  ( $+140^{\circ}\text{F}$ ) pour les versions EXP/USA, inférieures à  $-15^{\circ}\text{C}$  ( $+5^{\circ}\text{F}$ ) ou supérieures à  $+55^{\circ}\text{C}$  ( $+131^{\circ}\text{F}$ ) pour les versions CHN/EUR/FRG/HOL/UK, et inférieures à  $-10^{\circ}\text{C}$  ( $+14^{\circ}\text{F}$ ) ou supérieures à  $+55^{\circ}\text{C}$  ( $+131^{\circ}\text{F}$ ) pour les version AUS.

**NE PAS** nettoyer l'émetteur-récepteur avec des produits chimiques tels que l'essence ou l'alcool susceptibles d'endommager la surface de la radio.

**NE PAS** appuyer sur la touche [PTT] sans intention réelle d'émettre.

**NE PAS** modifier l'émetteur-récepteur. La garantie de l'émetteur-récepteur ne couvre pas les problèmes résultant d'une modification non autorisée.

**NE PAS** utiliser l'émetteur-récepteur à proximité de détonateurs électriques non blindés ou dans une atmosphère explosive.

**GARDEZ** l'émetteur-récepteur hors de la portée des enfants

**MAINTENIR** l'émetteur-récepteur au moins 0,9 m (3,0 pieds) du compas de route magnétique du navire.

---

# SAFETY TRAINING INFORMATION

---



Your Icom radio generates RF electromagnetic energy while transmitting. This radio is designed for and classified as for “Occupational Use Only.” This means it must be used only during the course of employment by individuals aware of the hazards, and the ways to minimize such hazards. This radio is NOT intended for use by the “General Population” in an uncontrolled environment. This radio has been tested and complies with the FCC and IC RF exposure limits for “Occupational Use Only.” In addition, your Icom radio complies with the following Standards and Guidelines with regard to RF energy and electromagnetic energy levels and evaluation of such levels for exposure to humans:

- FCC KDB Publication 447498 D03, Evaluating Compliance with FCC Guidelines for Human Exposure to Radio Frequency Electromagnetic Fields.
- American National Standards Institute (C95.1-2019), IEEE Standard for Safety Levels with Respect to Human Exposure to Radio Frequency Electromagnetic Fields, 0 Hz to 300 GHz.
- American National Standards Institute (C95.3-2002), IEEE Recommended Practice for the Measurement of Potentially Hazardous Electromagnetic Fields— RF and Microwave.
- The accessories listed on page 43 are authorized for use with this product. Use of accessories other than those specified may result in RF exposure levels exceeding the FCC and IC requirements for wireless RF exposure.
- Health Canada Safety Code 6 - Limits of Human Exposure to Electromagnetic Energy in the Frequency Range from 3 kHz to 300 GHz.



To ensure that your exposure to RF electromagnetic energy is within the FCC and IC allowable limits for occupational use, always adhere to the following guidelines:

- **DO NOT** operate the radio without a proper antenna attached, as this may damage the radio and may also cause you to exceed FCC and IC RF exposure limits. A proper antenna is the antenna supplied with this radio by the manufacturer or an antenna specifically authorized by the manufacturer for use with this radio.
- **DO NOT** transmit for more than 50% of the total radio use time (“50% duty cycle”). Transmitting more than 50% of the time can cause FCC and IC RF exposure compliance requirements to be exceeded. The radio is transmitting when “TX” is displayed on the function display. You can cause the radio to transmit by pushing the “PTT” switch.
- **ALWAYS** keep the antenna at least 2.5 cm (1 inch) away from the body when transmitting, and only use the Icom belt-clips listed on page 43 when attaching the radio to your belt, or other place, to ensure FCC and IC RF exposure compliance requirements are not exceeded.

The information listed above provides the user with the information needed to make him or her aware of RF exposure, and what to do to assure that this radio operates within the FCC and IC RF exposure limits of this radio.

## **Electromagnetic Interference/Compatibility**

During transmissions, your Icom radio generates RF energy that can possibly cause interference with other devices or systems. To avoid such interference, turn off the radio in areas where signs are posted to do so. **DO NOT** operate the transmitter in areas that are sensitive to electromagnetic radiation such as hospitals, aircraft, and blasting sites.

## **Occupational/Controlled Use**

The radio transmitter is used in situations in which persons are exposed as a consequence of their employment, provided those persons are fully aware of the potential for exposure and can exercise control over their exposure.

# INFOMATION EN MATIÈRE DE SÉCURITÉ



AVERTISSEMENT

Votre radio Icom produit une énergie électromagnétique de radiofréquences (RF), en mode de transmission. Cette radio est conçue pour un «usage professionnel seulement» et classée comme tel, ce qui signifie qu'elle doit être utilisée uniquement dans le cadre d'un travail par des personnes

conscientes des dangers et des mesures visant à minimiser ces dangers. Elle N'EST PAS conçue pour une «utilisation grand public», dans un environnement non contrôlé. Cet appareil a été évalué et jugé conforme, aux limites d'exposition aux RF de la FCC et d'IC, pour une «utilisation grand public». En outre, votre radio Icom satisfait les normes et directives qui suivent en matière de niveaux d'énergie et d'énergie électromagnétique de RF et d'évaluation de tels niveaux en ce qui concerne l'exposition humaine:

- Publication 447498 D03 de la FCC KDB, «Evaluating Compliance with FCC Guidelines for Human Exposure to Radio Frequency Electromagnetic Fields».
- Norme de l'American National Standards Institute (ANSI): IEEE C95.1-2019 sur les niveaux de sécurité compatibles avec l'exposition humaine aux champs électromagnétiques de radiofréquences (0 Hz à 300 GHz).
- Norme de l'ANSI: IEEE C95.3-2002 sur la méthode d'évaluation recommandée du champ magnétique potentiellement dangereux des radiofréquences et des micro-ondes.
- Les accessoires illustrés à la p. 43 sont approuvés pour une utilisation avec ce produit. L'utilisation d'accessoires autres que ceux précisés peut entraîner des niveaux d'exposition aux RF supérieures aux limites établies par la FCC et d'IC en matière d'exposition aux RF sans fil.
- Le Code de sécurité 6 de Santé Canada - Les limites d'exposition humaine à l'énergie électromagnétique dans la gamme de fréquences de 3 kHz à 300 GHz.



MISE EN GARDE

Afin de vous assurer que votre exposition à une énergie électromagnétique de RF se situe dans les limites permises par la FCC et d'IC pour une utilisation grand public, veuillez en tout temps respecter les directives suivantes :

- **NE PAS** faire fonctionner la radio sans qu'une antenne appropriée y soit fixée, car ceci risque d'endommager la radio et causer une exposition supérieure aux limites établies par la FCC et d'IC. L'antenne appropriée est celle qui est fournie avec cette radio par le fabricant ou une antenne spécialement autorisée par le fabricant pour être utilisée avec cette radio.
- **NE PAS** émettre pendant plus de 50% du temps total d'utilisation de l'appareil («50% du facteur d'utilisation»). Émettre pendant plus de 50% du temps total d'utilisation peut causer une exposition aux RF supérieure aux limites établies par la FCC et d'IC. La radio est en train d'émettre lorsque le témoin du "TX" s'affiche sur l'écran ACL. La radio émettra si vous appuyez sur le bouton du microphone.
- **TOUJOURS** tenir l'antenne éloignée d'au moins 2,5 cm de votre corps au moment d'émettre et utiliser uniquement l'attache pour ceinture Icom illustrée à la p. 43, lorsque vous attachez la radio à votre ceinture, ou à autre chose, de façon à vous assurer de ne pas provoquer une exposition aux RF supérieure aux limites fixées par la FCC et d'IC.

Les renseignements ci-dessus fournissent à l'utilisateur toute l'information nécessaire sur l'exposition aux RF et sur ce qu'il faut faire pour assurer que cette radio fonctionne en respectant les limites d'exposition aux RF établies par la FCC et d'IC.

## Interférence électromagnétique et compatibilité

En mode de transmission, votre radio Icom produit de l'énergie de RF qui peut provoquer des interférences avec d'autres appareils ou systèmes. Pour éviter de telles interférences, mettez la radio hors tension dans les secteurs où une signalisation l'exige. **NE PAS** faire fonctionner l'émetteur dans des secteurs sensibles au rayonnement électromagnétique tels que les hôpitaux, les aéronefs et les sites de dynamitage.

## Usage professionnel/contrôlé

Ce radio émetteur est utilisé dans des cas où des personnes sont exposées en raison de leur travail, pourvu qu'elles soient conscientes du risque d'exposition qu'elles puissent exercer un contrôle sur cette exposition.

---

## IN CASE OF EMERGENCY

---

If your vessel requires assistance, contact other vessels and the Coast Guard by sending a distress call on Channel 16.

○ **USING CHANNEL 16**

### **DISTRESS CALL PROCEDURE**

1. "MAYDAY MAYDAY MAYDAY."
2. "THIS IS ....." (name of vessel)
3. Say your call sign or other indication of the vessel.
4. "LOCATED AT ....." (your position)
5. State the nature of the distress and assistance required.
6. Give any other information which might facilitate the rescue.

---

## RECOMMENDATION

---

**CLEAN THE TRANSCEIVER THOROUGHLY IN A BOWL OF FRESH WATER** after exposure to saltwater, and dry it before operating. Otherwise, the transceiver's keys, switches and controllers may become unusable, due to salt crystallization, and/or the charging terminals of the battery pack may corrode.

**NOTE: IF** the transceiver's waterproof protection appears defective, carefully clean it with a soft, damp (fresh water) cloth, then dry it before operating. The transceiver may lose its waterproof protection if the case, jack cap, or connector cover is cracked or broken, or the transceiver has been dropped. Contact your Icom distributor or your dealer for advice.

---

# TABLE OF CONTENTS

---

IMPORTANT .....	i	■ About the function mode .....	17
EXPLICIT DEFINITIONS .....	i	■ Manual recording function (Depending on versions) .....	18
PRECAUTIONS .....	ii	■ Automatic recording function (Depending on versions) .....	19
PRÉCAUTIONS .....	iii	■ Play back function (Depending on versions) .....	20
SAFETY TRAINING INFORMATION .....	iv	■ Channel naming function .....	21
INFOMATION EN MATIÈRE DE SÉCURITÉ .....	v	■ Opening comment entry function .....	22
IN CASE OF EMERGENCY .....	vi	■ ATIS code programming (For only the Dutch and German versions) .....	23
RECOMMENDATION .....	vi	■ Backlight function .....	24
<b>1 OPERATING RULES .....</b>	<b>1</b>	<b>8 SET MODE .....</b>	<b>25–30</b>
<b>2 SUPPLIED ACCESSORIES AND ATTACHMENTS .....</b>	<b>2–3</b>	■ SET mode programming .....	25
■ Supplied accessories .....	2	■ SET mode items .....	26
■ Attachments .....	2	<b>9 BATTERY CHARGING .....</b>	<b>31–34</b>
<b>3 PANEL DESCRIPTION .....</b>	<b>4–7</b>	■ Battery cautions .....	31
■ Front, top and side panels .....	4	■ Supplied battery charger .....	33
■ Function display .....	6	■ Optional battery chargers .....	34
<b>4 BASIC OPERATION .....</b>	<b>8–13</b>	<b>10 OPTIONAL SWIVEL BELT CLIP .....</b>	<b>35</b>
■ Channel selection .....	8	■ Attaching .....	35
■ Receiving and transmitting .....	11	■ Detaching .....	35
■ Call channel programming .....	12	<b>11 OPTIONAL SPEAKER-MICROPHONE .....</b>	<b>36</b>
■ Lock function .....	12	■ HM-167 descriptions .....	36
■ Monitor function .....	12	■ Attaching .....	36
■ Adjusting the squelch level .....	13	<b>12 TROUBLESHOOTING .....</b>	<b>37</b>
■ AquaQuake water draining function .....	13	<b>13 SPECIFICATIONS .....</b>	<b>38–39</b>
<b>5 SCAN OPERATION (Except for the Dutch version) .....</b>	<b>14–15</b>	<b>14 VHF MARINE CHANNEL LIST .....</b>	<b>40–42</b>
■ Scan types .....	14	<b>15 OPTIONS .....</b>	<b>43</b>
■ Setting Favorite channels .....	15	<b>16 INFORMATIONS .....</b>	<b>44</b>
■ Starting a scan .....	15	■ FCC INFORMATION .....	44
<b>6 DUALWATCH/TRI-WATCH (Except for the Dutch version) .....</b>	<b>16</b>	■ INFORMATION FCC .....	44
■ Description .....	16	■ ABOUT CE AND DOC .....	44
■ Operation .....	16	■ DISPOSAL .....	44
<b>7 FUNCTION MODE OPERATION .....</b>	<b>17–24</b>	<b>INDEX .....</b>	<b>45–46</b>



## ◇ Priorities

- Read all rules and regulations pertaining to call priorities, and keep an up-to-date copy handy. Safety and distress calls take priority over all others.
- You must monitor Channel 16 when you are not operating on another channel.
- False or fraudulent distress calls are prohibited under law.

## ◇ Privacy

- Information overheard, but not intended for you, cannot lawfully be used in any way.
- Indecent or profane language is prohibited.

## ◇ Radio licenses

### (1) SHIP STATION LICENSE

You may require a current radio station license before using the transceiver. It is unlawful to operate a ship station which is not licensed, but required to be.

If required, contact your dealer or the appropriate government agency for a Ship-Radiotelephone license application. This government-issued license states the call sign which is your craft's identification for radio purposes.

### (2) OPERATOR'S LICENSE

A Restricted Radiotelephone Operator Permit is the license most often held by small vessel radio operators when a radio is not required for safety purposes.

If required, the Restricted Radiotelephone Operator Permit must be posted or kept with the operator. If required, only a licensed radio operator may operate a transceiver.

However, non-licensed individuals may talk over a transceiver if a licensed operator starts, supervises, ends the call and makes the necessary log entries.

A current copy of the applicable government rules and regulations is only required to be on hand for vessels in which a radio telephone is compulsory. However, even if you are not required to have these on hand it is your responsibility to be thoroughly acquainted with all pertinent rules and regulations.

**NOTE:** Even though the transceiver is capable of operation on VHF marine channels 1021, 1023, 1081, 1082 and 1083, according to FCC regulations these simplex channels cannot be lawfully used by the general population in USA waters.

## ■ Supplied accessories

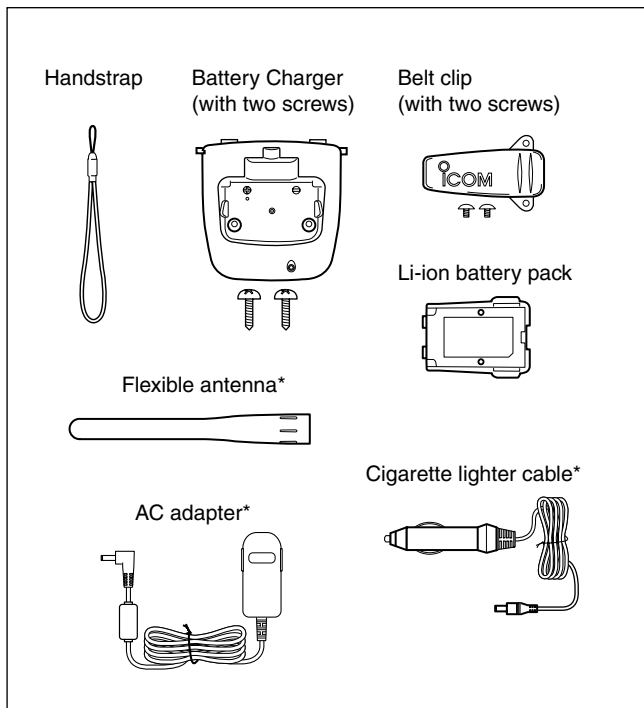

\* Not supplied or different type may be supplied depending on the transceiver version.

## ■ Attachments

### ◇ Flexible antenna

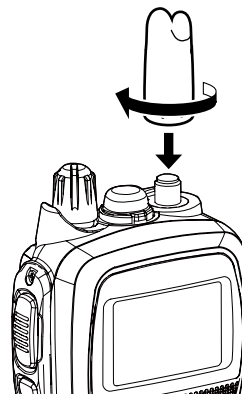

Connect the supplied flexible antenna to the antenna connector.

#### CAUTION:

- **NEVER** carry the transceiver by holding the antenna.
- **DO NOT** transmit without an antenna.

### ◇ Handstrap

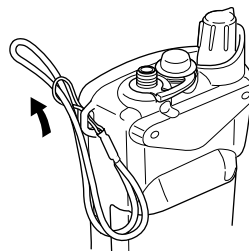

Pass the handstrap through the loop on the top corner of the transceiver, as illustrated to the left. This facilitates carrying the transceiver.

### ◇ Battery pack

- ① Attach the battery pack into the transceiver.

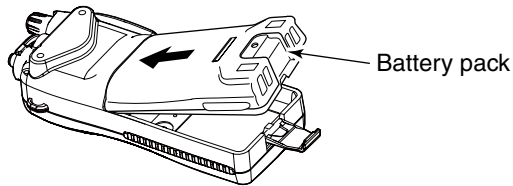

- ② Lock the battery pack with the latch.

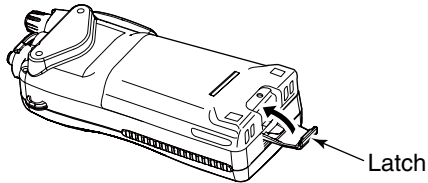

### CAUTION:

**NEVER** remove or attach the battery pack when the transceiver is wet or soiled. This may result in water or dust getting into the transceiver and battery pack, and may result in them being damaged.

**Be careful!** The latch is tightly locked, so use caution when releasing it. **DO NOT** use your finger nail. Use the edge of a coin or screwdriver tip to carefully release it.

### ◇ Belt clip

- Attach the belt clip to the transceiver.

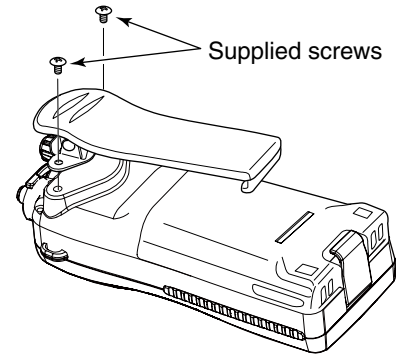

## ■ Front, top and side panels

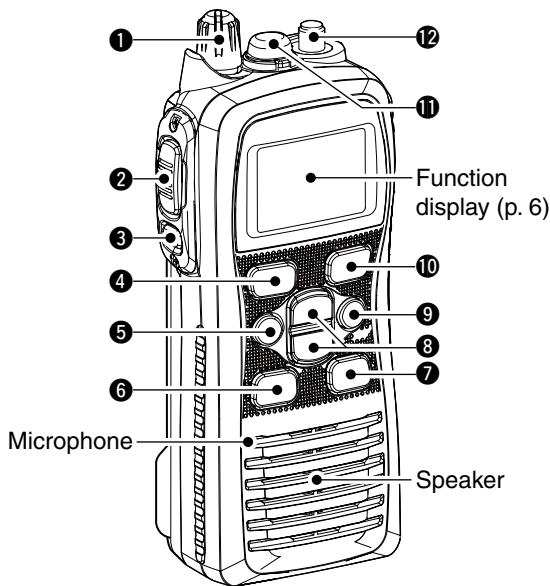

### ① VOLUME CONTROL [VOL]

Turns ON power and adjusts the audio level.

### ② PTT SWITCH [PTT]

Hold down to transmit; release to receive.

### ③ MONITOR KEY [M]

- Manually opens the squelch to monitor the channel while held down. (p. 12)
- Push this switch, then adjust the squelch level with [▲]/[▼]. (p. 13)
- While holding down this switch, turn the ON power to enter the SET mode. (p. 25)

### ④ CHANNEL 16 KEY [16/C]

- Selects Channel 16 when pushed. (p. 8)
- Selects the Call channel when pushed for 1 second. (p. 8)
- Enters the Call channel write mode when the Call channel is selected and this key is held down for 3 seconds. (p. 12)

### ⑤ FUNCTION KEY [F]

- Enters the Function mode when pushed. (p. 17)
- The AquaQuake function is activated when held down for 1 second. (p. 13)
- While holding down this key, turn ON the power to enter the recording counter mode.

**6 SCAN KEY [SCAN•DUAL]**

This key may not be available depending on the transceiver version.

- Starts and stops normal or priority scan when pushed. (pp. 14, 15)
- Enters the Watch mode when held down for 1 second. (p. 16)

**7 CHANNEL/WEATHER CHANNEL KEY [CH/WX•U/I/C] (IC-M73), [CH] (IC-M73EURO)**

- Selects and toggles the regular channels and weather channel\* when pushed. (pp. 9, 10)
- Selects the U.S.A., International, Canadian or ATIS channel group\* when held down for 1 second. (p. 9)  
- The function display shows which channel group is active.
- Push to return to the display before you selected the channel when the priority channel or the Call channel is selected.

\* Selectable contents differ depending on the transceiver version.

 **NOTE:** [CH/WX•U/I/C] and [CH] are described as [CH/WX•U/I/C] in this instruction manual.

**8 CHANNEL UP/DOWN KEYS [▲]/[▼]**

- Selects the operating channel. (pp. 8–10)
- Selects the SET mode option of the item. (p. 25)
- Selects the SET mode item when pushed along with [(F)]. (p. 25)
- Checks Favorite (TAG) channels, or changes the scanning direction during a scan. (p. 15)
- Selects the Function mode item. (p. 17)

**9 TRANSMIT POWER/LOCK KEY [H/L•LOCK]**

- Selects high, middle or low power when pushed. (p. 11)
- Toggles the lock function ON/OFF when held down for 1 second. (p. 12)

**10 FAVORITE (TAG) KEY [FAV•★]**

- Push this key to sequentially select the Favorite (TAG) channels, while ignoring untagged channels, in a channel group. (p. 15)
- Hold down for 1 second to set or clear the displayed channel as a Favorite (TAG) channel. (p. 15)
- While holding down this key, turn ON power to clear or set all Favorite (TAG) channels in the selected channel group. (p. 15)

**11 SPEAKER-MICROPHONE CONNECTOR [SP MIC]**

Connects the optional external speaker-microphone. (p. 36)

 **NOTE:** Attach the [SP MIC] cap when the optional speaker-microphone is not used.

**12 ANTENNA CONNECTOR**

Connects the supplied antenna. (p. 2)

### 3 PANEL DESCRIPTION

## ■ Function display

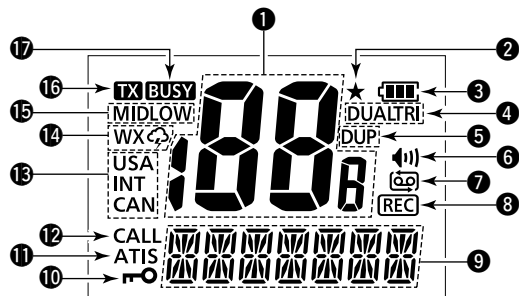

#### 1 CHANNEL NUMBER READOUT





- Indicates the selected operating channel number.
- In the SET mode, indicates the selected value.

#### 2 FAVORITE CHANNEL ICON (p. 15)

Appears when a Favorite (TAG) channel is selected.

#### 3 BATTERY ICON

Indicates remaining battery power.

Indication				
Battery level	Full	Middle	Low	No battery (Charging required)

 blinks when the battery is overcharged (or over voltage).

#### 4 DUALWATCH/TRI-WATCH ICONS (p. 16)

“DUAL” blinks during dualwatch; “TRI” blinks during tri-watch. This may not appear depending on the transceiver version.

#### 5 DUPLEX ICON (p. 9)

Appears when a duplex channel is selected.

#### 6 MONITOR ICON (p. 12)

Appears when the monitor function is activated.

#### 7 AUTOMATIC RECORDING ICON (p. 19)

Appears when the automatic recording is activated. This may not appear depending on the transceiver version.

#### 8 RECORDING ICON

Appears while the receiving audio is recording. (pp. 18, 19)  
This may not appear depending on the transceiver version.

#### 9 CHANNEL NAME FIELD

- Indicates or scrolls the operating channel name, comment or ATIS code\*. (pp. 21–23)
- \*For only the Dutch and German versions.
- In the SET and Function mode, indicates or scrolls the selected item. (pp. 25–30)
- “SCAN 16” is displayed during a Priority scan; “SCAN” appears during a Normal scan. (p. 15)

#### 10 LOCK ICON (p. 12)

Appears when the lock function is activated.

**11 ATIS ICON** (pp. 9, 23)

Appears when the channel group, in which ATIS function is activated, is selected or while programming an ATIS code.

- For only the HOL and FRG versions.

**12 CALL CHANNEL ICON** (p. 8)

Appears when the Call channel is selected.

**13 CHANNEL GROUP ICON** (p. 9)

“USA” appears when U.S.A.\*1; “INT” appears when International; “CAN” appears when the Canadian\*2; “ATIS” appears when ATIS\*3 channel group is selected.

\*1Only USA, UK, EXP, CHN and AUS versions.

\*2Only USA, EXP and CHN versions.

\*3Only HOL version.

**14 WEATHER CHANNEL/WEATHER ALERT ICONS\*** (p. 10)

- “WX” appears when the Weather channel group is selected.
- “WX” appears when the Weather alert function is activated.

\*Selectable on only the USA, EXP, AUS and CHN versions.

**15 TRANSMIT POWER ICONS** (p. 11)

- “LOW” appears when low power is selected.
- “MID” appears when mid power is selected.
- No indication appears when high power is selected.

**16 TRANSMIT ICON** (p. 11)

Appears during transmit.

**17 BUSY ICON** (pp. 11, 12)

Appears when a signal is received, or the squelch opens.

## ■ Channel selection

**IMPORTANT!** Prior to using the transceiver for the first time, fully charge the battery pack. This will help maximize the capability and life of the battery. To avoid damage to the transceiver, turn OFF the radio while charging.

### ◇ Channel 16

Channel 16 is the distress and safety channel. It is used for establishing initial contact with another station, and for emergency communications. Channel 16 is automatically monitored during both Dualwatch and Tri-watch. While standing by, you must monitor Channel 16.

- ① Push **[16/C]** to select Channel 16.
- ② Push **[CH/WX•U/I/C]** to return to the condition before selecting Channel 16, or push **[▲]/[▼]** to select the operating channel.

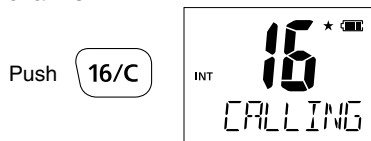

### ◇ Call channel

Each regular channel group has separate leisure-use call channels. The Call channel is monitored during Tri-watch. The Call channels can be reprogrammed (p. 12) and may be used to store your most often-used channels in each channel group for quick recall.

- ① Hold down **[16/C]** for 1 second to select the Call channel.
  - “CALL” and the call channel number appear.
  - The Call channel can be re-programmed. See the “Call channel programming” on page 12 for details.
- ② Push **[CH/WX•U/I/C]** to return to the screen before you selected Call channel, or push **[▲]/[▼]** to select an operating channel.

Hold down **[16/C]**  
for 1 second





◇ U.S.A., International, Canadian and ATIS channels

The transceiver has U.S.A.\*1, International, Canadian\*2 and ATIS\*3 channels. You must select the proper channels for the operating area.

\*1Only USA, UK, EXP, CHN and AUS versions.  
 \*2Only USA, EXP and CHN versions.  
 \*3Only HOL version.

- ① Push [CH/WX•U/I/C] to select a regular channel.
  - If the weather channel appears, push [CH/WX•U/I/C] again.
- ② Push [▲]/[▼] to select a channel.
  - “DUP” appears for duplex channels.
- ③ To change the channel group, hold down [CH/WX•U/I/C] for 1 second.
  - Repeat until you reach the desired channel group.

For U.K. and Australia versions

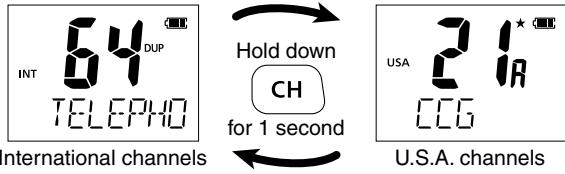

For Dutch version

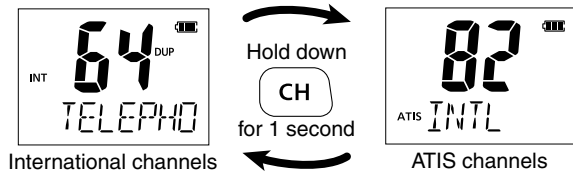

For U.S.A., Export, and China versions

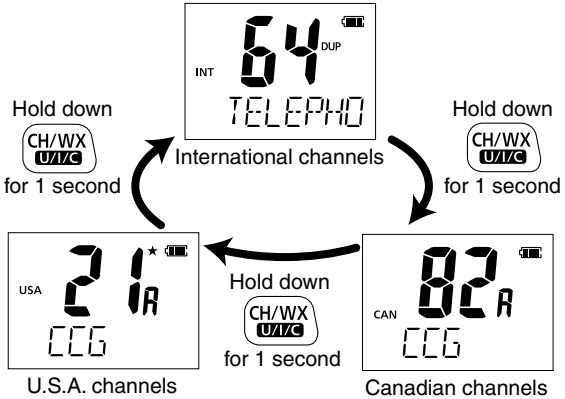

## 4 BASIC OPERATION

### ◇ Weather channels

The transceiver has 10 pre-programmed weather channels\*. These are used for monitoring broadcasts from NOAA (National Oceanographic and Atmospheric Administration.) The transceiver can automatically detect a weather alert tone on the selected weather channel or while scanning.

See the “SET mode items” on page 26 for details.

\* For only the USA, EXP, AUS and CHN versions.

- ① Push **[CH/WX•U//C]** to select the weather channel group.
- ② Push **[▲]/[▼]** to select a weather channel.
- ③ Push **[CH/WX•U//C]** to return to the screen before you selected the Weather channel group.

The Weather channel list

WX channel	Frequency (MHz)	
	Transmit	Receive
1	RX only	162.550
2	RX only	162.400
3	RX only	162.475
4	RX only	162.425
5	RX only	162.450
6	RX only	162.500
7	RX only	162.525
8	RX only	161.650
9	RX only	161.775
10	RX only	163.275

## ■ Receiving and transmitting

**CAUTION: DO NOT** transmit without an antenna.

- ① Rotate **[VOL]** clockwise to turn ON power.
  - An opening comment scrolls across the function display.
  - Push **[16/C]** to skip the opening comment.
- ② Set the volume and squelch level.
  - ➔ Push **[L/R]**, and push **[▼]** to open the squelch.
  - ➔ Rotate **[VOL]** to set the volume level.
  - ➔ Push **[L/R]**, and push **[▲]/[▼]** to set the squelch level.
- ③ Push **[▲]/[▼]** to select the desired channel.
  - Pushing **[FAV•★]** selects only Favorite channels.
  - When receiving a signal, the “**BUSY**” icon appears while audio is heard from the speaker.
  - Further adjustment of **[VOL]** may be necessary at this point.
- ④ Push **[H/L•LOCK]** to select the output power, if necessary.
  - “LOW” appears when low power is selected; “MID” appears when mid power is selected; no indication is displayed when high power is selected.
  - Choose low or mid power to conserve battery power; choose high power for longer distance communications.
  - Some channels are for only low transmission.
- ⑤ Hold down **[PTT]** to transmit, and speak at your normal voice level.
  - The **TX** appears while transmitting.
  - Channel 70 cannot be used for transmission.
- ⑥ Release **[PTT]** to receive.

**IMPORTANT:** To maximize the readability of your transmitted signal, pause a second after pushing **[PTT]**. Hold the microphone 5 to 10 cm (2 to 4 inches) from your mouth, and speak at your normal voice level.

**NOTE:** The transceiver has a power save function to conserve the battery power. The power save function automatically activates when no signal is received for 5 seconds.

The Time-out Timer function\* cuts OFF transmission after 5 minutes of continuously transmitting, to prevent prolonged transmission.

10 seconds before transmission is cut OFF, a beep sounds and “TOT” blinks to indicate that the transmission will be cut OFF. After it is cut OFF, “TIME OUT” is displayed for 10 seconds, and you cannot transmit until it disappears.

\* This function may not be installed in some transceiver versions.

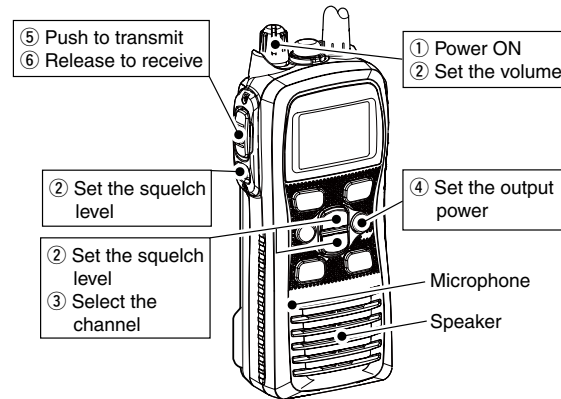

## 4 BASIC OPERATION

### ■ Call channel programming

The Call channel key is used to select Channel 9\* by default. However, you can program your most often-used channel in each channel group for quick recall.

\* The channel may differ, depending on the transceiver version.

① Hold down **[CH/WX•U/I/C]** for 1 second several times to select the desired channel group (USA, INT, CAN, ATIS) to be programmed.

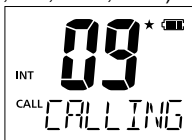

② Hold down **[16/C]** for 1 second to select the Call channel.

• “CALL” and Call channel number appear.

③ Hold down **[16/C]** again for 3 seconds (until a long beep changes to 2 short beeps) to enter the Call channel programming mode.

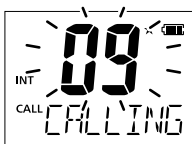

• The Call channel number to be programmed blinks.

④ Push **[▲]/[▼]** to select the desired channel.

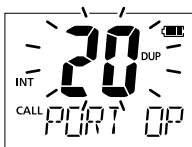

⑤ Push **[16/C]** to program the displayed channel as the Call channel.

• The Call channel number stops blinking.

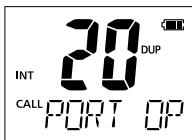

### ■ Lock function

This function electronically locks all keys (except for **[PTT]**, **[MUTE]** and **[H/L•LOCK]**) to prevent accidental channel changes and function access.

➔ Push **[H/L•LOCK]** for 1 second to turn the lock function ON or OFF.

Hold down  for 1 second

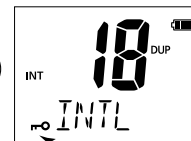

← Appears while the lock function is in use.

### ■ Monitor function

The monitor function releases the noise squelch mute to check the volume level. See page 27 for details of the monitor switch action.

➔ Hold down **[MUTE]** for 1 second to activate the monitor function.

• “**[MUTE]**” and “**BUSY**” appear and audio is heard.

Hold down  for 1 second

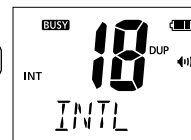

← Appears while the monitor function is in use.

## ■ Adjusting the squelch level

To adjust the transceiver's squelch level, use the [▲]/[▼] keys, as described below. In order to properly receive signals, as well as for the scan to function effectively operate, the squelch must be adjusted to the proper level.

- ① Push [(M)], then adjust the squelch level with [▲]/[▼].
  - "SQL" and the squelch level are displayed.
  - There are 11 squelch levels to choose from: OP is completely open; 10 is tight squelch; 1 is loose squelch level.
  - When no key is pushed for 5 seconds, the transceiver returns to its normal condition.
- ② Push [(M)] again to return to normal operating mode.

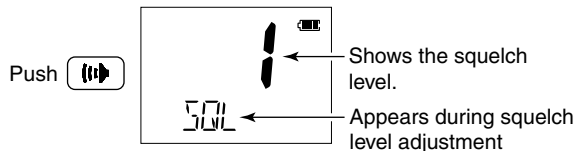

## ■ AquaQuake water draining function

The AquaQuake water draining function clears water away from the speaker grill. Without this function, water may muffle the sound coming from the speaker. The transceiver emits a vibrating beep when this function is activated.

- ➔ While holding down [F], the AquaQuake function is activated to clear water away from the speaker grill.
  - Beep sounds, regardless of the volume level setting.
  - Activates for 10 seconds in maximum to drain water.
  - The transceiver never accepts key operation while the AquaQuake function is activated.
  - The AquaQuake function can not be activated when an optional speaker-microphone is connected.

## ■ Scan types

Scanning is an efficient way to quickly locate signals over a wide frequency range. The transceiver has a priority scan setting and normal scan setting.

In addition, the “Weather alert\*” and “Auto scan” functions are also selectable for scanning. These functions can be simultaneously activated, depending on the settings in the SET mode. (pp. 26, 27)

\* For only the USA, EXP, AUS and CHN versions.

### NORMAL SCAN

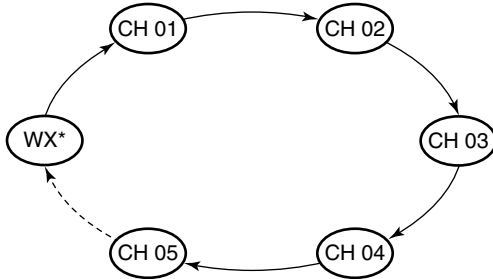

\* Previously selected weather channel when weather alert function is ON.

Normal scan, like priority scan, sequentially searches through all Favorite channels. However, unlike priority scan, Channel 16 is not checked unless it is set as a Favorite channel.

Set the Favorite channels (scanned channel) before scanning. Clear those Favorite channels which are not needed or inconveniently stop scanning, such as digital communications.

/// Choose priority or normal scan in the SET mode. (p. 26)

### PRIORITY SCAN

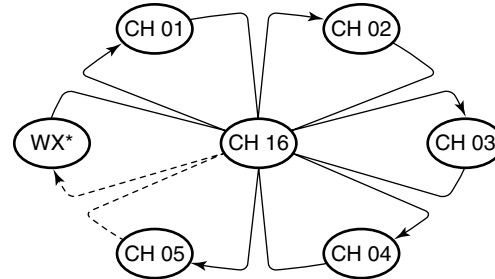

\* Previously selected weather channel when weather alert function is ON

Priority scan sequentially searches through all Favorite channels while monitoring Channel 16. When a signal is detected on Channel 16, the scan pauses until the signal disappears; when a signal is detected on a channel other than Channel 16, scan becomes Dualwatch until the signal disappears.

## ■ Setting Favorite channels

For more efficient scanning, add desired channels as Favorite channels, or clear the Favorite for unwanted channels. Untagged channels will be skipped during scanning. Favorite channels can be independently assigned to each channel group (USA, INT, CAN, ATIS) independently.

- ① Select the desired channel to set as a Favorite channel.
- ② Hold down **[FAV•★]** for 1 second to set the displayed channel as a Favorite channel.
  - “★” appears on the function display.
- ③ To cancel the Favorite channel setting, hold down **[FAV•★]** for 1 second.
  - “★” disappears.

### Clearing (or setting) All Favorite Channels in the Selected Channel Group

While holding down **[FAV•★]**, turn ON power to clear all the Favorite channel settings in the channel group.

- Repeat above procedure to set all channels as Favorite channels.

## ■ Starting a scan

First, set the weather alert function, priority scan function, scan resume timer and auto scan function, using the SET mode. (pp. 26, 27)

- ① Make sure the desired channel group (e.g., USA, CAN, INT, ATIS) is selected. Move between channel groups by repeatedly pushing **[CH/WX•U//C]** for 1 second at a time.
  - When the weather alert function\* is in use, select the desired weather channel with **[CH/WX•U//C]** and **[▲]/[▼]**.
  - \* For only the USA, EXP, AUS and CHN versions.
- ② Push **[SCAN•DUAL]** to start a priority or normal scan.
  - “SCAN” blinks in the function display.
  - “16” appears on the comment indicator during a priority scan.
  - When a signal is received, the scan pauses until the signal disappears, or resumes after pausing 5 seconds, depending on the scan resume timer setting. (Channel 16 is still monitored during a priority scan.)
  - Push **[▲]/[▼]** to check the scanning of Favorite channels, change the scanning direction or resume the scan manually.
- ③ To stop the scan, push **[SCAN•DUAL]**.
  - “SCAN” disappears.

**[Example]:** Starting a normal scan.

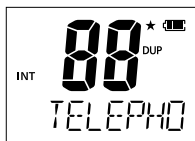

Scan starts

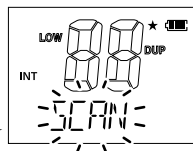

“SCAN” indication blinks

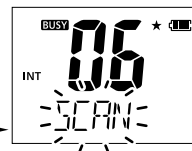

When receiving a signal, “SCAN” indication blinks and audio is heard.



to stop the scan

## ■ Description

Dualwatch monitors Channel 16 while you are receiving on another channel; Tri-watch monitors Channel 16 and the call channel while receiving on another channel.

### DUALWATCH/TRI-WATCH SIMULATION

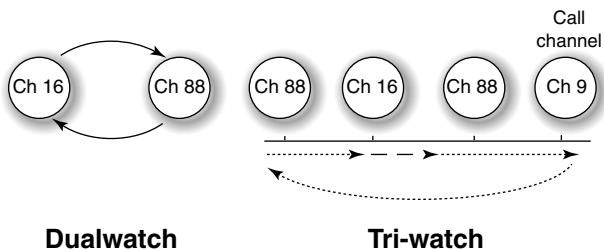

- If a signal is received on Channel 16, Dualwatch/Tri-watch pauses on Channel 16 until the signal disappears.
- If a signal is received on the Call channel during Tri-watch, Tri-watch becomes Dualwatch until the signal disappears.
- To transmit on the selected channel during Dualwatch/Tri-watch, hold down [PTT].

## ■ Operation

- ① Select a desired operating channel.
- ② Hold down [SCAN•DUAL] for 1 second to start Dualwatch or Tri-watch (depending on the SET mode setting; p. 27).
  - “DUAL” blinks during Dualwatch; “TRI” blinks during Tri-watch.
  - A beep tone sounds when a signal is received on Channel 16.
  - Tri-watch becomes Dualwatch when receiving a signal on the Call channel.
- ③ To cancel Dualwatch/Tri-watch, push [SCAN•DUAL] again.

**[Example]:** Operating tri-watch on INT channel 07.

Hold down **SCAN**  
**DUAL** for 1 second

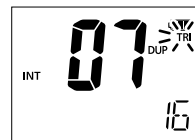

Tri-watch starts.

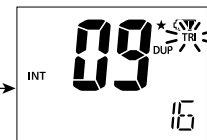

A signal is received on the Call channel.

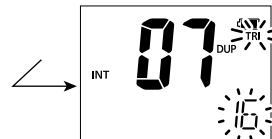

A signal received on Channel 16 always takes priority.

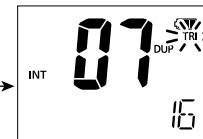

Tri-watch resumes after the signal disappears.



## ■ About the function mode

There are 7 transceiver functions<sup>‡</sup> in the function mode: Play back function<sup>‡</sup>, Manual recording function<sup>‡</sup>, Automatic recording function<sup>‡</sup>, backlight function, channel naming function, opening comment entry function and the ATIS code programming function<sup>†</sup>.

<sup>†</sup>For only the Dutch and German versions.

<sup>‡</sup>Depending on versions.

### ◇ Entering the function mode

- ① Push **[F]** to enter the function mode.
  - “PLAY” (Play back function) appears.
  - When no key is pushed for 5 seconds, the transceiver returns to its normal condition.
- ② Push **[▲]/[▼]** to select the desired item.
- ③ Push **[H/L•LOCK]** to select or decide the desired option of the item.
  - Some items exit the function mode when pushing **[H/L•LOCK]**.
- ④ To exit the function mode, push **[F]**.

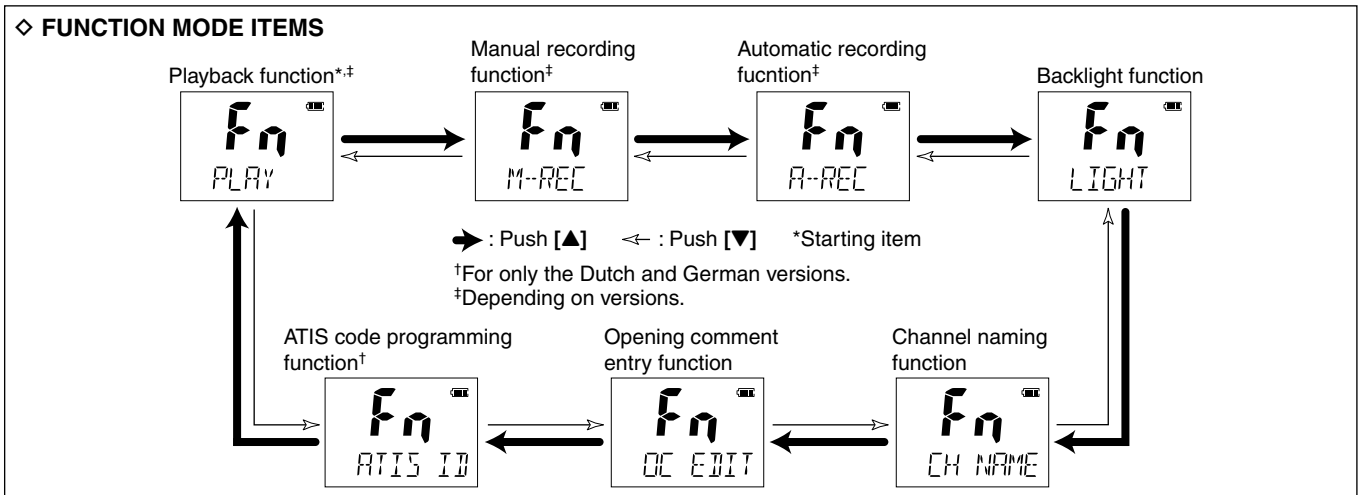

## Manual recording function (Depending on versions)

You can record the received signal whenever you want by using the manual recording function.

This function can record the received signal for maximum 30 seconds.

- ▨ The transmitted signal cannot be recorded.
- ▨ The previously recorded signal will be overwritten when you record the next audio using this function.

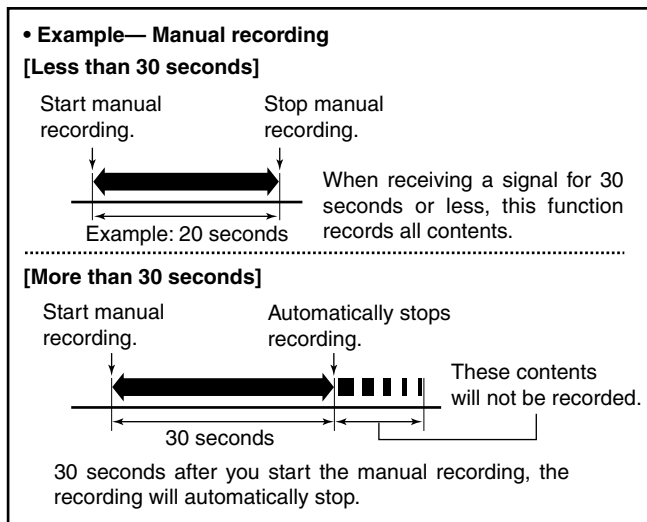

- ① Push **[F]** to enter the function mode, and then push **[▲]/[▼]** to select the manual recording function.
  - “M-REC” appears.
- ② Push **[H/L•LOCK]** to start recording.
  - “REC” appears.
  - When the signal disappears, the transceiver continues recording without audio.
- ③ Push **[F]** to stop the recording.
  - The recording will automatically stop after 30 seconds.



Manual recording mode appears.



“REC” appears while recording.

# ■ Automatic recording function (Depending on versions)

When this function is turned ON, the transceiver automatically records the received signal into the memory. The maximum recording time is 60 seconds.

- The transmit signal cannot be recorded.
- If a signal less than 60 seconds is recorded, the next recorded signal is added into the same data.
- The recording threshold level can be set in the set mode. See page 30 for details.

**NOTE:** Even if you turn OFF the transceiver, this function remains ON.

**• Example— Automatic recording**  
**[Less than 60 seconds]**  
 Starts recording      Stops recording

Example: 40 seconds      When receiving a signal for 60 seconds or less, this function records all contents.

---

**[More than 60 seconds]**  
 Starts recording      Stops recording

These contents won't be recorded.      After 60 seconds has passed from starting the automatic recording, this function records the 60 seconds before stopping to record.

- ① Push **[F]** to enter the function mode, and then push **[▲]/[▼]** to select the automatic recording function.
  - “A-REC” appears.
- ② Push **[H/L•LOCK]** to turn the function ON or OFF.
  - The automatic recording icon appears when the function is turned ON.
  - After pushing **[H/L•LOCK]**, exits the function mode.
- ③ When a signal is received, the transceiver automatically starts recording.
  - “REC” appears while recording.
  - The recording will automatically stop when the received signal disappears, or the received signal strength becomes weaker than the set threshold level in the set mode (p. 30).



Automatic recording mode appears.

Automatic recording icon appears.



“REC” is appeared while recording.

## ■ Play back function (Depending on versions)

This transceiver has two voice recorders. One is the manual recording function which can record for 30 seconds. The other is the automatic recording function which can record the last 60 seconds of the receiving signal. There are three play-back modes as follows.

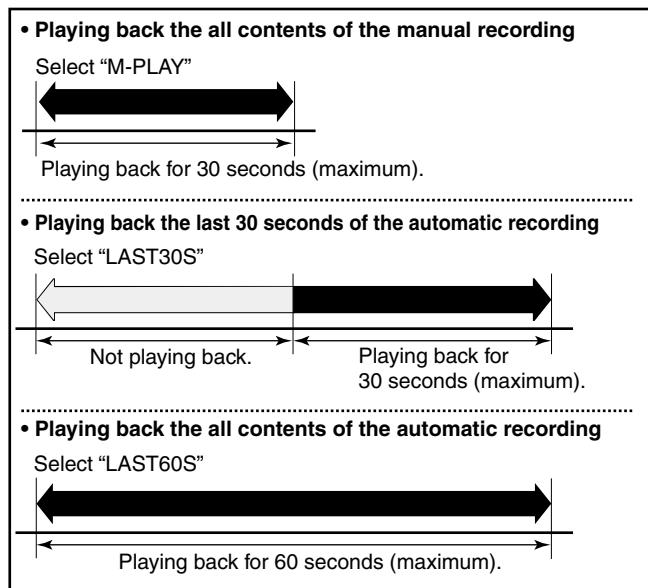

- ① Push **[F]** to enter the function mode.
  - "PLAY" appears.
- ② Push **[H/L•LOCK]** to enter the play back selection mode, and then push **[▲]/[▼]** to select the desired play back mode from "M-PLAY," "LAST30S," or "LAST60S." If there is no recorded signal in the transceiver, "BLANK" appears.

- M-PLAY : Play back the manually recorded signal.
- LAST30S: Play back the last 30 seconds of the automatically recorded signal.
- LAST60S: Play back the automatically recorded signal for 60 seconds.

Blinks while playbacking.



Playback mode appears.

- ③ Push **[H/L•LOCK]** to play back the recorded signal.
  - "PL" blinks.
  - To stop the play back, push **[H/L•LOCK]** again.

**DO NOT** detach the battery pack while the transceiver is turned ON. Otherwise, the data could be lost or deleted.



"BLANK" appears when the transceiver has no recorded signal.

### **Deleting a recorded signal:**

While selecting the desired data to delete, hold down **[FAV•★]** for 3 seconds until 2 short beeps sound.

## ■ Channel naming function

The IC-M73/IC-M73EURO can assign up to 10-character channel names for each operating channel, including each weather channel. This provides easy recognition of the channel in use, or station names.

When shipped from the factory, the IC-M73/IC-M73EURO is programmed with default names for each VHF marine channel. These defaults can be changed, if desired.

### ◇ Usable characters

-- (=)	※ (*)	+ (+)	-- (-)	, (,)	' (/)	0 (0)	1 (1)	2 (2)	3 (3)
4 (4)	5 (5)	6 (6)	7 (7)	8 (8)	9 (9)	(Space)	A (A)	B (B)	C (C)
D (D)	E (E)	F (F)	G (G)	H (H)	I (I)	J (J)	K (K)	L (L)	M (M)
N (N)	O (O)	P (P)	Q (Q)	R (R)	S (S)	T (T)	U (U)	V (V)	W (W)
X (X)	Y (Y)	Z (Z)	a (a)	b (b)	c (c)	d (d)	e (e)	f (f)	g (g)
h (h)	i (i)	j (j)	k (k)	l (l)	m (m)	n (n)	o (o)	p (p)	q (q)
r (r)	s (s)	t (t)	u (u)	v (v)	w (w)	x (x)	y (y)	z (z)	

### ◇ Channel name programming

- ① Push [▲]/[▼] to select a channel to program.
  - Hold down [CH/WX•U//C] for 1 second to select a channel group, if necessary.
- ② Push [F] to enter the function mode, and then push [▲]/[▼] to select the channel naming function.
  - “CH NAME” appears.
- ③ Push [H/L•LOCK] to edit the channel name.
  - The 1st character of the currently programmed name blinks.
- ④ Push [▲]/[▼] to select a character.
- ⑤ Push [CH/WX•U//C] to move to the right; then push [▲]/[▼] to select a character.
  - Push [SCAN•DUAL] to move to the left.
- ⑥ Continue until the desired characters have been selected, then push [H/L•LOCK] to return to normal operation.

#### **Deleting a channel name (All clear):**

While selecting the desired channel name in the channel name editing mode, push [FAV•★] to delete the selected channel name.



## ■ Opening comment entry function

The IC-M73/IC-M73EURO can assign up to 16-character opening comments.

You may replace the factory-set opening comment with a comment of your own. The opening comment appears each time the IC-M73/IC-M73EURO is powered ON. The comment may be up to 16 characters long.

You can use same characters as “Channel naming function.” (p. 21)

### ◇ Opening comment programming

- ① Push **[F]** to enter the function mode, and then push **[▲]/[▼]** to select the opening comment programming mode.
  - “OC EDIT” appears.
- ② Push **[H/L•LOCK]** to edit the opening comment.
  - The 1st character of the currently programmed comment blinks.



- ③ Push **[▲]/[▼]** to select a character.
- ④ Push **[CH/WX•U/I/C]** to move to the right; then push **[▲]/[▼]** to select a character.
  - Pushing **[SCAN•DUAL]**, moves to left.
- ⑤ Continue until the desired characters have been entered, then push **[H/L•LOCK]** to return to normal operation.



### Deleting the opening comment (All clear):

While in the opening comment editing mode, push **[FAV•★]** to delete.

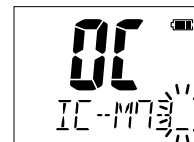

- ▨ The programmed opening comment is briefly displayed or scrolled when the transceiver is powered ON.
- ▨ However, the opening comment display can be skipped by pushing **[16/C]**.

## ■ ATIS code programming (For only the Dutch and German versions)

The 10-digit ATIS code can be programmed and confirmed with the following operation.

/// The ATIS code programming is not necessary and confirmation can only be performed when the ATIS code has been programmed by your dealer. The code programming can be performed 1 time only, if the code has not been programmed by your dealer.

- ① Push **[F]** to enter the function mode, and then push **[▲]/[▼]** to select the ATIS code programming function.
  - “ATIS ID” appears.
- ② Push **[H/L•LOCK]** to edit the ATIS code.
  - “Id” and “ATIS” appear, and the 1st character of the code blinks.
- ③ Push **[▲]/[▼]** to select a number.
- ④ Push **[CH/WX•U/I/C]** to move to the right; then push **[▲]/[▼]** to select a number.
  - Push **[SCAN•DUAL]** to move to the left.

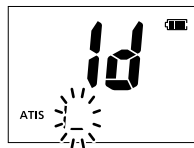

- ⑤ After inputting the 10-digit ATIS code, push **[H/L•LOCK]** to write the code into the memory, then goes to the ATIS code confirmation mode.

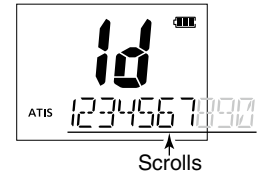

### *Deleting the ATIS code (All clear):*

While in the ATIS code editing mode, push **[FAV•★]** to delete.

### ◇ ATIS code confirmation

(When the ATIS code has been programmed)

- ① Push **[F]** to enter the function mode, and then push **[▲]/[▼]** to select the ATIS code programming function.
  - “ATIS ID” appears.
- ② Push **[H/L•LOCK]** to confirm the ATIS code.
  - “Id” and “ATIS” appear.
  - The ATIS code is displayed and scrolls in the channel comment display.
- ③ Push **[H/L•LOCK]** to return to normal operation.

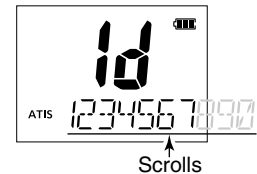

### ■ Backlight function

This function is convenient for nighttime operation. The backlighting can also be turned OFF in the SET mode. (p. 27)

- Push any key other than **[PTT]** to turn ON the backlighting.
  - The backlighting is automatically turned OFF after 5 seconds of inactivity.

- ① Push **[F]** to enter the function mode, and then push **[▲]/[▼]** to select the backlighting function.

- "LIGHT" appears.

- ② Push **[H/L•LOCK]** to turn the function ON or OFF.

- After pushing **[H/L•LOCK]**, exits from the function mode.



Backlight mode  
appears.



## ■ SET mode programming

The SET mode is used to change the status of 17 transceiver functions†: Beep tone function, Weather alert function†, Priority scan, Scan resume timer, Auto scan start function, Dual/Tri-watch function, Monitor key action, Display backlight, LCD contrast selection, Power save function, Scroll type selection, Scroll speed selection, RX noise cancel function†, TX noise cancel function†, RX bass boost function†, TX bass boost function† and the Automatic recording threshold level selection†.

### ◇ SET mode operation

- ① Turn OFF power.
- ② While holding down [F], turn ON power to enter the SET mode.
  - The “BEEP” (Beep tone function setting) appears.
- ③ Push [F], or push [F] and [▲]/[▼] to select the desired item.
- ④ Push [▲]/[▼] to select the desired option of the item.
- ⑤ To exit the SET mode, push [16/C].

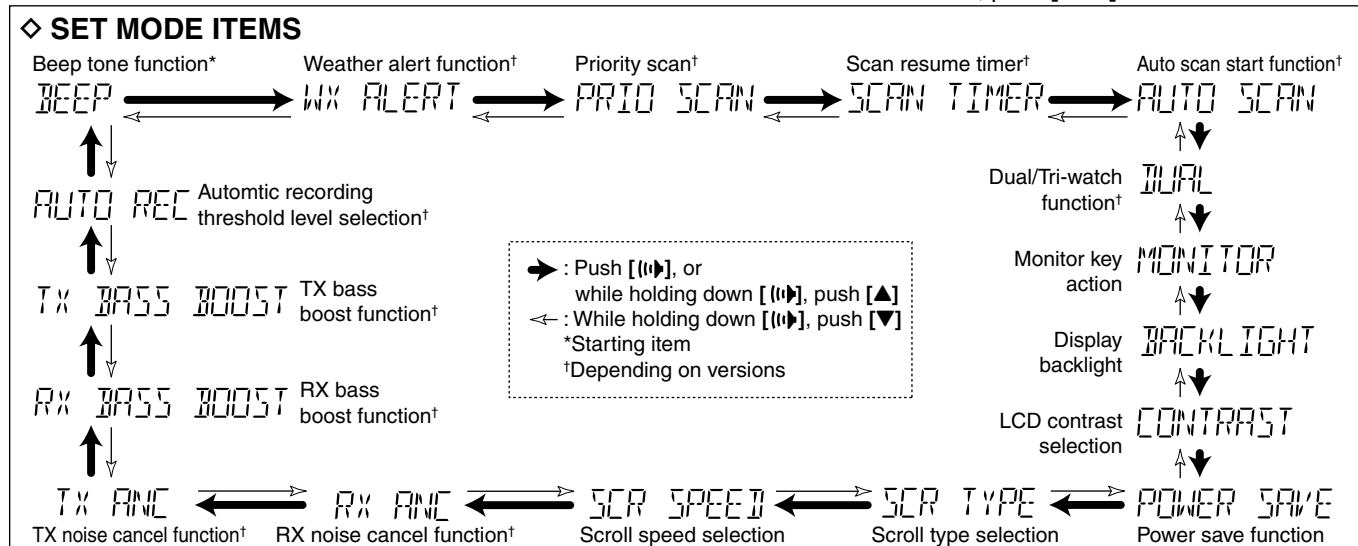

## ■ SET mode items

### ◇ Beep tone function

“BEEP”

Turns ON the key touch beep sound or AJ, or turns OFF the sound OFF.

- ON : A fixed beep sounds (default)
- AJ : The preset beeps (example: do, re, mi) sound
- OFF : Silent operation

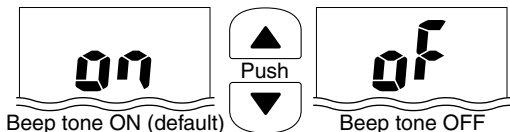

### ◇ Weather alert function

“WX ALERT”

For only the USA, EXP, AUS and CHN versions, a NOAA broadcast station transmits a weather alert tone before any important weather announcements. When the weather alert function is turned ON, any detected weather alert will make the IC-M73/IC-M73EURO activate a blinking “WX” alert icon on the function display and repeatedly sound a beep tone. The blinking and beeping stops when the radio is picked up and operated. The previously selected weather channel is checked any time during standby, or while scanning, when the power save function is activated.

- “WX” appears when the function is turned ON.

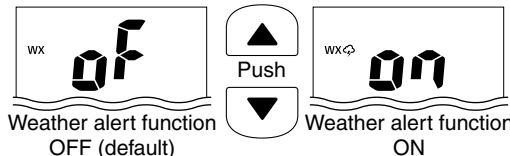

### ◇ Priority scan function

“PRIO SCAN”

Except for the HOL version, the transceiver has 2 scan types— normal (OFF) and priority (ON) scans. Normal scan searches all Favorite (TAG) channels in the selected channel group. Priority scan sequentially searches all Favorite (TAG) channels while monitoring Channel 16.

- The default setting may differ, depending on the version.

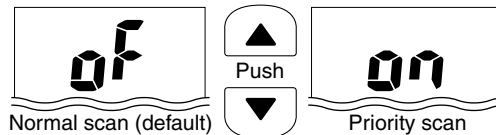

### ◇ Scan resume timer

“SCAN TIMER”

Except for the HOL version, the scan resume timer can be set as a pause (OFF) or timer scan (ON). When OFF is selected, the scan pauses until a received signal disappears. When ON is selected, the scan pauses for 5 seconds after receiving a signal and then resumes even if a signal has been received.

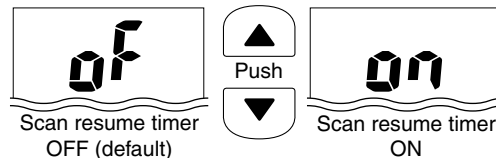

◇ **Auto scan function**

“AUTO SCAN”

Except for the HOL version, the auto scan function automatically starts the desired scan when no signal is received, and no operation is performed for 30 seconds

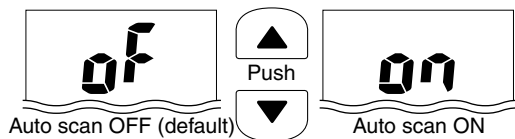

◇ **Dual/Tri-watch function**

“DUAL”

Except for the HOL version, this item selects Dual or Tri-watch as desired. See page 16 for details.

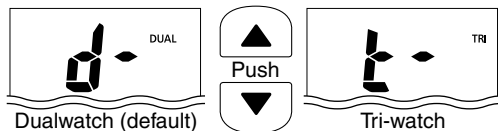

◇ **Monitor key action**

“MONITOR”

The monitor key action temporarily cuts off the squelch function. This key action contains PUSH (Pu) or HOLD (Ho) settings, as shown below.

- Pu (PUSH): After pushing [MON] for 1 second, the squelch opens and audio is heard. The squelch is held open while continuously holding down [MON]. (default)
- Ho (HOLD): After pushing [MON] for 1 second, the squelch opens and audio is heard even if [MON] is released. To close the squelch, push any key.

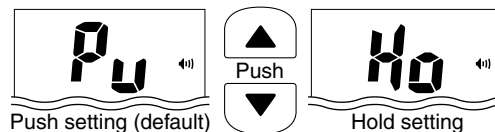

◇ **Backlight function**

“BACKLIGHT”

This function is convenient for nighttime operation. The backlight can be turned ON or OFF.

- The backlight is automatically activated when any key except for [PTT] is pushed.
- The backlight is automatically turned OFF after 5 seconds of inactivity.

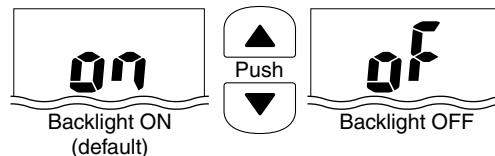

## 8 SET MODE

### ◇ LCD contrast selection

“CONTRAST”

The contrast of the LCD can be set to Hi (default) or Lo.

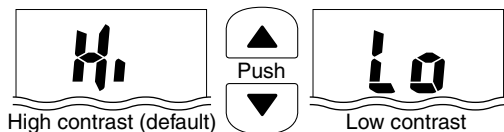

### ◇ Auto power save function

“POWER SAVE”

The auto power save function reduces current drain by deactivating the receiver circuit for preset intervals.

- ON : The power save function is turned ON. The power save function will activate when no signal is received, and no operation is performed for 5 seconds
- OFF : The power save function is turned OFF.

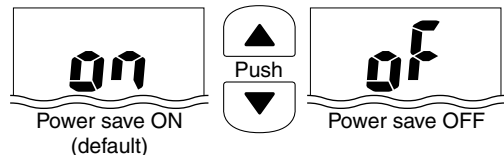

### ◇ Channel name scroll type

“SCR TYPE”

Set the channel name/comment scroll type to 1 or 2.

- 1: The first 7 characters are displayed for approximately 1 second then scrolls. When the channel name or comment is 7 character or less, it does not scroll (default).
- 2: The channel name or comment scrolls regardless of the number of characters after no name or comment (blank) is displayed for 1 second.

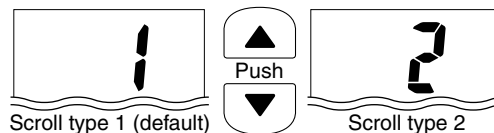

### ◇ Scrolling speed

“SCR SPEED”

Selects the channel name/comment scroll speed.

- 1: Scrolls 3.33 characters in a second.
- 2: Scrolls 2.5 characters in a second.
- 3: Scrolls 2 characters in a second.

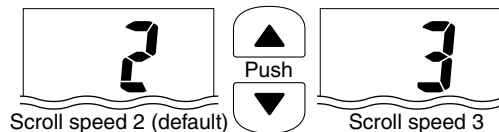

### ◇ RX Noise Cancel function

“RX ANC”

Set the Noise Cancel function for reception. The function may not be available, depending on the transceiver version.

- OFF : Turns OFF the function.
- 1 : The Noise Cancel function reduces random noise components in the received signal to approximately one half.
- 2 : The Noise Cancel function reduces random noise components in the received signal to approximately one third.
- 3 : The Noise Cancel function reduces random noise components in the received signal to approximately one tenth.

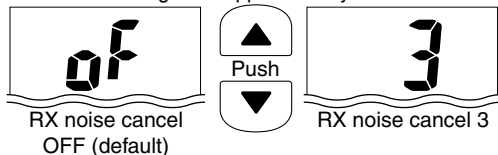

### ◇ TX Noise Cancel function

“TX ANC”

Set the Noise Cancel function for transmission. The function may not be available, depending on the transceiver version.

- OFF : Turns OFF the function.
- ON : The Noise Cancel function reduces random noise components in the transmitted signal to one third.

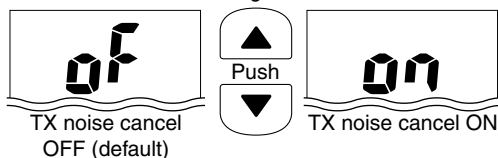

### ◇ RX bass boost function

“RX BASS BOOST”

Set the bass boost function for reception. The function may not be available, depending on the transceiver version.

- OFF : Turns OFF the function.
- ON : The RX bass boost function boosts the bass level of the receive audio tone.

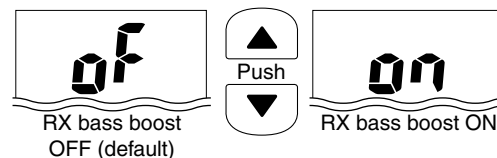

### ◇ TX bass boost function

“TX BASS BOOST”

Set the bass boost function for transmission. The function may not be available, depending on the transceiver version.

- OFF : Turns OFF the function.
- ON : The TX bass boost function boosts the bass level of the transmit audio tone.

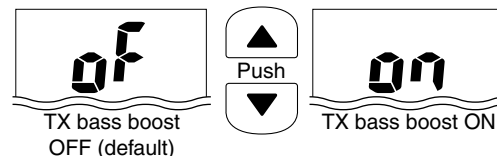

## 8 SET MODE

### ◇ Automatic recording threshold level

*“AUTO REC”*

Set the automatic recording threshold level. The function may not be available, depending on the transceiver version.

- 1 : Set the threshold level to shallow. Weak signals will automatically be recorded into memory.
- 2 : Set the threshold level to mid.
- 3 : Set the threshold level to deep. Weak signals will not automatically be recorded into memory.

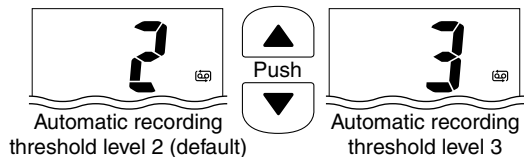

## ■ Battery cautions

Misuse of Li-ion batteries may result in the following hazards: smoke, fire, or the battery may rupture. Misuse can also cause damage to the battery or degradation of battery's performance.

### ◇ Battery caution

⚠ **DANGER! DO NOT** hammer or otherwise impact the battery. Do not use the battery if it has been severely impacted or dropped, or if the battery has been subjected to heavy pressure. Battery damage may not be visible on the outside of the case. Even if the surface of the battery does not show cracks or any other damage, the cells inside the battery may rupture or catch fire.

⚠ **DANGER! NEVER** use or leave battery pack in areas with temperatures above +60°C (+140°F). High temperature build-up in the battery, such as could occur near fires or stoves, inside a sun-heated car, or by setting the battery in direct sunlight may cause the battery to rupture or catch fire. Excessive temperatures may also degrade battery performance or shorten battery life.

⚠ **DANGER! NEVER** incinerate a used battery pack since internal battery gas may cause a rupture or explosion.

⚠ **DANGER! DO NOT** expose the battery to rain, snow, seawater, or any other liquids. Do not charge or use a wet battery. If the battery gets wet, be sure to wipe it dry before using. The battery by itself is not waterproof.

⚠ **DANGER! NEVER** solder the battery terminals, or **NEVER** modify the battery pack. This may cause heat generation, and the battery may rupture, emit smoke or catch fire.

⚠ **DANGER!** Use the battery only with the transceiver for which it is specified. Never use a battery with any other equipment, or for any purpose that is not specified in this instruction manual.

⚠ **DANGER!** If fluid from inside the battery gets in your eyes, blindness can result. Rinse your eyes with clean water, without rubbing them, and see a doctor immediately.

⚠ **WARNING!** Immediately stop using the battery if it emits an abnormal odor, heats up, or is discolored or deformed. If any of these conditions occur, contact your Icom dealer or distributor.

⚠ **WARNING! NEVER** use deteriorated battery packs. They could cause a fire.

⚠ **WARNING!** Immediately wash, using clean water, any part of the body that comes into contact with fluid from inside the battery.

⚠ **WARNING! NEVER** put the battery in a microwave oven, high-pressure container, or in an induction heating cooker. This could cause overheating, a fire, or cause the battery to rupture.

**CAUTION:** Always use the battery within the specified temperature range for the transceiver\* and the battery itself (–20°C to +60°C; –4°F to +140°F).

* EXP/USA:	–20°C to +60°C; –4°F to +140°F
CHN/EUR/FRG/HOL/UK:	–15°C to +55°C; +5°F to +131°F
AUS:	–10°C to +55°C; +14°F to +131°F

## 9 BATTERY CHARGING

Using the battery out of its specified temperature range will reduce the battery's performance and battery life. Please note that the specified temperature range of the battery may exceed that of the transceiver. In such cases, the transceiver may not work properly because it is out of its operating temperature range.

**CAUTION:** Shorter battery life could occur if the battery is left fully charged, completely discharged, or in an excessive temperature environment (above +50°C; +122°F) for an extended period of time. If the battery must be left unused for a long time, it must be detached from the radio after discharging. You may use the battery until the remaining capacity is about half, then keep it safely in a cool dry place with the temperature range as below;

-20°C to +50°C	(-4°F to +122°F)	(within a month)
-20°C to +35°C	(-4°F to +95°F)	(within three months)
-20°C to +20°C	(-4°F to +68°F)	(within a year)

**BE SURE** to replace the battery pack with a new one approximately five years after manufacturing, even if it still holds a charge. The inside battery material will become weak after a period of time, even with little use. The estimated number of times you can charge the battery is between 300 and 500. Even when the battery appears to be fully charged, the operating time of the radio may become short when:

- Approximately five years have passed since the battery was manufactured.
- The battery has been repeatedly charged.

### ◇ Charging caution

⚠ **DANGER! NEVER** charge the battery pack in areas with extremely high temperatures, such as near fires or stoves, inside a sun-heated car, or in direct sunlight. In such environments, the safety/protection circuit in the battery will activate, causing the battery to stop charging.

⚠ **WARNING! NEVER** charge the transceiver during a lightning storm. It may result in an electric shock, cause a fire or damage the transceiver. Always disconnect the power adapter before a storm.

⚠ **WARNING! DO NOT** charge or leave the battery in the battery charger beyond the specified time for charging. If the battery is not completely charged by the specified time, stop charging and remove the battery from the battery charger. Continuing to charge the battery beyond the specified time limit may cause a fire, overheating, or the battery may rupture.

⚠ **WARNING!** Occasionally observe the battery pack condition while charging. If any abnormal condition occurs, discontinue using the battery pack.

⚠ **WARNING! NEVER** insert the battery and transceiver (battery attached to the transceiver) into the charger if it is wet or soiled. This could corrode the battery charger terminals or damage the charger. The charger is not waterproof.

**CAUTION: DO NOT** charge the battery outside of the specified temperature range: +10°C to +40°C (+50°F to +104°F). Icom recommends charging the battery at +20°C (+68°F). The battery may heat up or rupture if charged out of the specified temperature range. Additionally, battery performance or battery life may be reduced.



## ■ Supplied battery charger

### ◇ BC-210 installation

- To a desktop  
Supplied screws

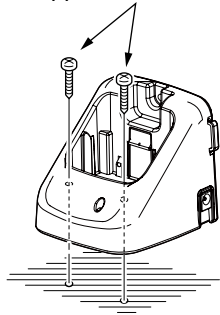

- To a wall  
Supplied screws

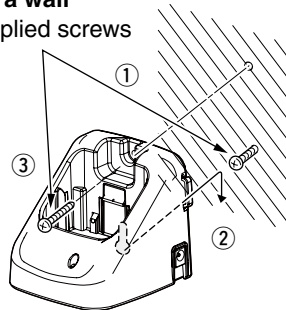

- For added stability



**Eyelet:**  
Use a rubber band to secure the transceiver if desired.

⚠ **DANGER!** Charge the BP-245H with only the specified chargers listed on page 43. Otherwise, it may cause smoke, fire, or cause the battery to burst.

### ◇ Charging

- ① Connect the AC adapter as shown below.
- ② Insert the battery pack with or without the transceiver into the charger.
  - The charge indicator lights orange.
- ③ Charge the battery pack approximately 3 hours, depending on the remaining power level.
  - The charge indicator lights green when charging is complete.

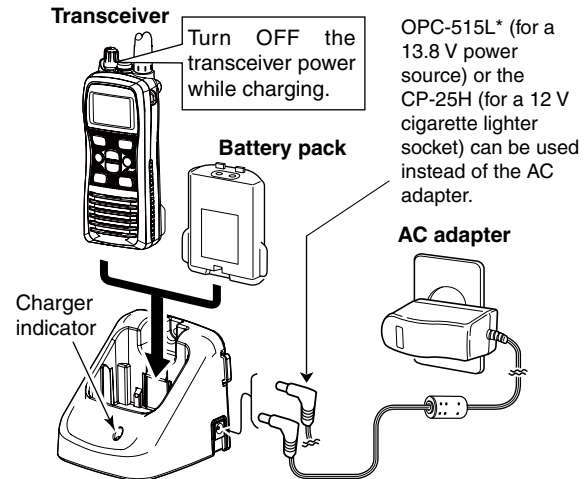

\***CAUTION: NEVER** connect the OPC-515L to a power source using reverse polarity. This will ruin the battery charger.  
White line: ⊕ Black line: ⊖

## Optional battery chargers

### ◇ AD-129 installation

- ① Connect the 8-pin connector of the each charger slot to the AD-129 desktop charger adapter's plug.
- ② Install the adapter into the each charger slot in the direction of the arrow, then use the two supplied screws to secure the adapter to the charger.

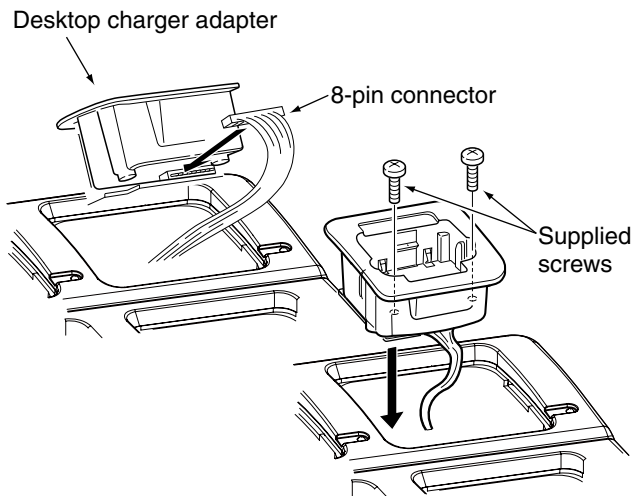

**⚠ DANGER!** Charge the BP-245H with only the specified chargers listed on page 43. Otherwise, it may cause smoke, fire, or cause the battery to burst.

### ◇ Rapid charging with the BC-197+BC-157S or OPC-656

The optional BC-197 with the BC-157S will simultaneously charge up to 6 Li-ion battery packs. The following items are additionally required. (Charging time: approximately 3 hours)

- Six AD-129 charger adapters
- An AC adapter (BC-157S) or the DC power cable (OPC-656)

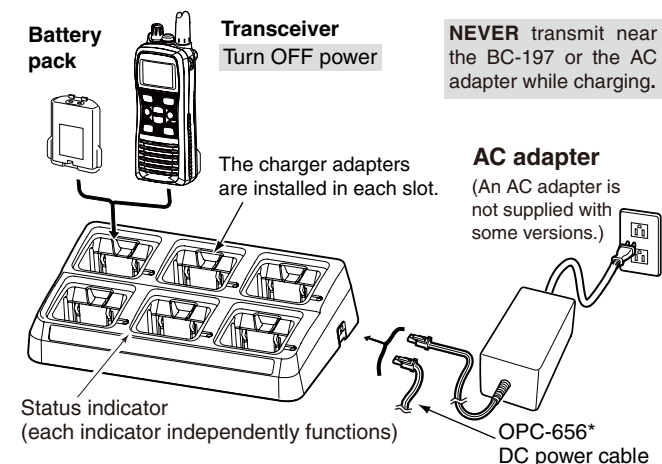

**\*DC power cable (OPC-656)**  
(Connect to a DC power supply: 12 to 16 V/at least 7 A)

**NEVER** reverse the polarity when connecting the power cable to a power source. This will ruin the battery charger.  
Red line : ⊕ Black line : ⊖

# OPTIONAL SWIVEL BELT CLIP 10

## ■ Attaching

- ① Screw the base clip to the back of the transceiver using the two screws (supplied), as shown to the right.

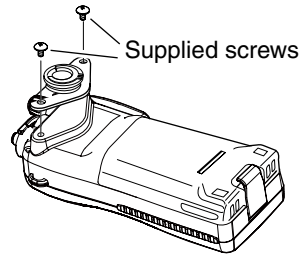

- ② Clip the belt clip over your belt and insert the transceiver.

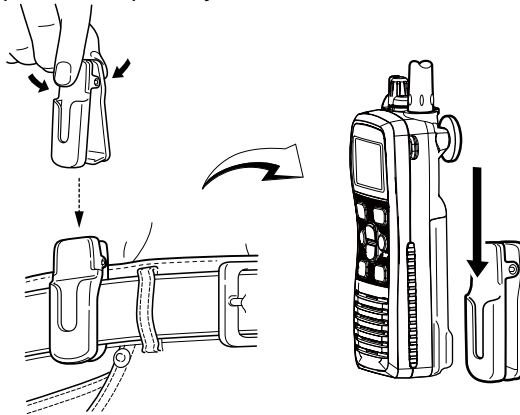

- ③ Once the transceiver is locked in place, it swivels.

## ■ Detaching

- ➔ Turn the transceiver upside down in the direction of the arrow and pull out from the belt clip.

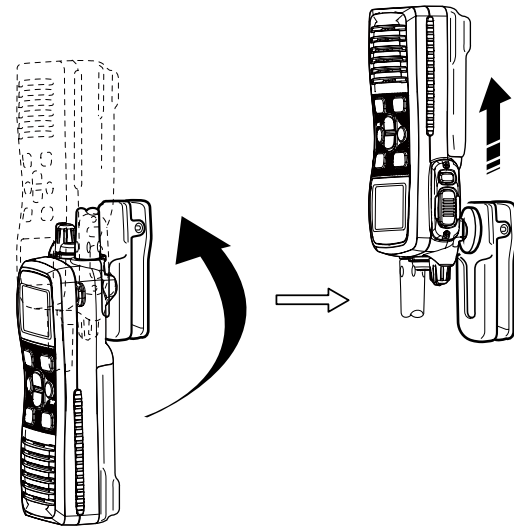

**⚠ CAUTION: HOLD THE TRANSCEIVER TIGHTLY WHEN HANGING OR DETACHING THE TRANSCEIVER FROM THE BELT CLIP.**

Otherwise the transceiver may not be attached to the belt clip or swivelled properly if the transceiver is accidentally dropped and the base clip is scratched or damaged.

## ■ HM-167 descriptions

HM-202 is also an optional speaker microphone. see the page 43 for details.

### Alligator type clip

To attach the speaker-microphone to your shirt or collar.

### PTT switch

Push to transmit.  
Release to receive.

### Microphone

### Speaker

Turn OFF the transceiver power when connecting the HM-167.

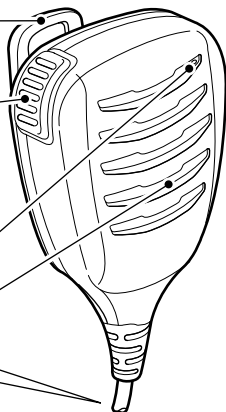

**NEVER** immerse the connector in water. If the connector becomes wet, be sure to dry it **BEFORE** attaching it to the transceiver.

**NOTE:** The microphone is located at the top of the speaker-microphone, as shown in the diagram above. To maximize the readability of your transmitted signal (voice), hold the microphone approximately 5 to 10 cm (2 to 4 inches) from your mouth, and speak in a normal voice level.

## ■ Attaching

Insert the speaker-mic connector onto the **[SP MIC]** connector and carefully screw it tight, as shown in the diagram below. Be careful not to cross-thread the connection.

Set the triangle mark to the front side.

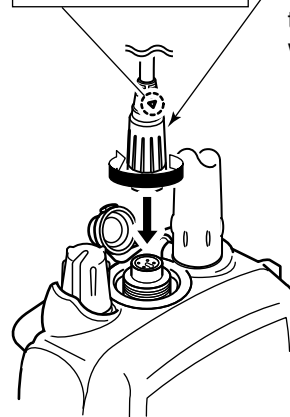

**CAUTION:** Attach the speaker-microphone's connector securely to prevent accidental dropping, or water intrusion in the connector.

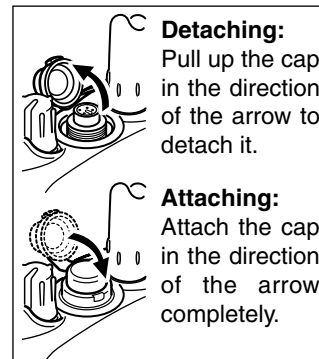

### Detaching:

Pull up the cap in the direction of the arrow to detach it.

### Attaching:

Attach the cap in the direction of the arrow completely.

**IMPORTANT: KEEP** the transceiver's **[SP MIC]** connector cap attached when the speaker-microphone is not in use. Water will not get into the transceiver even if the cover is not attached; however, the terminals (pins) will become rusty, or the transceiver will function abnormally if the connector has become wet.

PROBLEM	POSSIBLE CAUSE	SOLUTION	REF.
The transceiver does not turn ON.	<ul style="list-style-type: none"> <li>• The battery is depleted or the safety/protection circuit in the battery is activated.</li> <li>• Bad connection to the battery pack.</li> </ul>	<ul style="list-style-type: none"> <li>• Recharge the battery pack.</li> <li>• Check the connection to the transceiver.</li> </ul>	pp. 33, 34 p. 3
No sound from the speaker.	<ul style="list-style-type: none"> <li>• Squelch level is too tight.</li> <li>• Volume level is too low.</li> <li>• Speaker has been exposed to water.</li> <li>• Water has entered to [SP MIC] connector.</li> </ul>	<ul style="list-style-type: none"> <li>• Set squelch to the threshold point.</li> <li>• Rotate [VOL] to set a suitable level.</li> <li>• Hold down [F] to drain water from the speaker.</li> <li>• Dry [SP MIC] connector.</li> </ul>	p. 13 p. 11 p. 13 —
Transmitting is impossible, or high power can not be selected.	<ul style="list-style-type: none"> <li>• Some channels are for low power or receive only.</li> <li>• The battery is exhausted.</li> <li>• The battery is overcharged.</li> <li>• The output power is set to low.</li> <li>• The transceiver is over heated.</li> </ul>	<ul style="list-style-type: none"> <li>• Change channels.</li> <li>• Recharge the battery pack.</li> <li>• Verify the battery voltage is correct.</li> <li>• Push [H/L•LOCK] to select high power.</li> <li>• Turn OFF the power, leave it at room temperature for a while.</li> </ul>	pp. 11, 12, 40–42 pp. 33, 34 — p. 11 —
The displayed channel cannot be changed.	<ul style="list-style-type: none"> <li>• Lock function is activated.</li> </ul>	<ul style="list-style-type: none"> <li>• Push [H/L•LOCK] for 1 second to cancel the function.</li> </ul>	p. 12
Scan does not start.	<ul style="list-style-type: none"> <li>• Favorite (TAG) channels are not programmed.</li> </ul>	<ul style="list-style-type: none"> <li>• Set the desired channels as “Favorite (TAG)” channels.</li> </ul>	p. 15
No beeps.	<ul style="list-style-type: none"> <li>• Beep tones are turned OFF.</li> </ul>	<ul style="list-style-type: none"> <li>• Set the beep tones to ON (Fix Beep/Preset) in the SET mode.</li> </ul>	p. 26
Does not record or does not record properly.	<ul style="list-style-type: none"> <li>• The read/write capacity has been exceeded (the recording counter displays 100 or more. (p. 4)), or the memory is damaged.</li> </ul>	<ul style="list-style-type: none"> <li>• The memory IC should be replaced. Ask your technical dealer for service.</li> </ul>	—
The weak signal is not recorded by the automatic recording function.	<ul style="list-style-type: none"> <li>• The automatic recording threshold level is too deep.</li> </ul>	<ul style="list-style-type: none"> <li>• Set the automatic recording threshold level to shallow.</li> </ul>	p. 30
“CHARGE” comment blinks	<ul style="list-style-type: none"> <li>• The connected battery is depleted.</li> </ul>	<ul style="list-style-type: none"> <li>• Recharge the battery pack.</li> </ul>	pp. 33, 34

# 13 SPECIFICATIONS

## • IC-M73

### ◇ General

- Frequency coverage: Tx 156.025–157.425 MHz  
Rx 156.050–163.275 MHz  
FM (16K0G3E)
- Mode:
- Operating temperature range: –20°C to +60°C (–4°F to +140°F)
- Current drain (at 7.4 V): TX high 1.5 A  
(approximate) Max. audio 0.45 A
- Power supply requirement: 7.4 V DC nominal (negative ground)
- Frequency stability: ±10 ppm (–20°C to +60°C)
- Antenna impedance: 50 Ω nominal
- Dimensions (approximate): 52.5(W) × 125(H) × 30(D) mm  
(Projections not included) 2.0(W) × 4.9(H) × 1.2(D) inches
- Weight (approximate): 280 g/9.9 oz with BP-245H

### ◇ Transmitter

- Output power: 6 W/3 W/1 W
- Modulation system: Variable reactance frequency modulation
- Max. frequency deviation: ±5.0 kHz
- Adjacent channel power: 70 dB
- Spurious emissions (typical): –68 dBc

### ◇ Receiver

- Sensitivity (typical)  
USA and EXP versions: 0.22 μV (12 dB SINAD)
- Squelch sensitivity (at threshold, typical): 0.35 μV

Measurements made without an antenna.

- Intermodulation rejection ratio: 70 dB (typical)
- Spurious response rejection ratio: 70 dB (typical)
- Adjacent channel selectivity: 70 dB (typical)
- Audio output power (at 10% distortion with an 8 Ω load):  
0.35 W typical (External)  
0.7 W typical (Internal)

## • IC-M73EURO/IC-M73 (CHN version)

### ◇ General

- Frequency coverage: Tx 156.000–161.450 MHz  
156.000–161.600 MHz (CHN)  
Rx 156.000–163.425 MHz
- Mode: FM (16K0G3E)
- Operating temperature range: –15°C to +55°C
- Current drain (approximate): Tx (6 W) 1.5 A  
Tx (1 W) 0.7 A  
Tx (0.5 W) 0.6 A  
Rx Max. audio 0.45 A
- Power supply requirement: 7.4 V DC nominal (negative ground)
- Frequency stability: ±1.5 kHz
- Antenna impedance: 50 Ω nominal
- Dimensions (approximate): 52.5(W) × 125(H) × 30(D) mm  
(Projections not included)
- Weight (approximate): 280 g with BP-245H

◇ **Transmitter**

- Output power: 6 W/3 W/1 W/0.5 W\*  
\*German version only
- Modulation system: Variable reactance frequency modulation
- Max. frequency deviation: ±5 kHz
- Adjacent channel power: 70 dB
- Spurious emissions: 0.25 µW

◇ **Receiver**

- Sensitivity (typical): -4 dBµ emf at 20 dB SINAD
- Squelch sensitivity (threshold): -5 dBµ emf (typical)
- Intermodulation rejection ratio: 68 dB
- Spurious response rejection ratio: 70 dB
- Adjacent channel selectivity: 70 dB
- Audio output power (at 10% distortion with an 8 Ω load):  
0.2 W (External)  
0.7 W typical at 1 kHz (Internal)

• **IC-M73EURO** (AUS version)

◇ **General**

- Frequency coverage: Tx 156.025–157.425 MHz  
Rx 156.300–162.025 MHz
- Mode: FM (16K0G3E)
- Operating temperature range: -10°C to +55°C
- Current drain (at 7.4 V): TX high 1.4 A  
(approximate) Max. audio 0.45 A

- Power supply requirement: 7.4 V DC nominal (negative ground)
- Frequency stability: ±10 ppm (-10°C to +55°C)
- Antenna impedance: 50 Ω nominal
- Dimensions (approximate): 52.5(W) × 125(H) × 30(D) mm  
(Projections not included) 2.0(W) × 4.9(H) × 1.2(D) inches
- Weight (approximate): 280 g/9.9 oz with BP-245H

◇ **Transmitter**

- Output power: 5 W/3 W/1 W
- Modulation system: Variable reactance frequency modulation
- Max. frequency deviation: ±5.0 kHz
- Adjacent channel power: 70 dB
- Spurious emissions (typical): 0.25 µW

◇ **Receiver**

- Sensitivity (typical): -5 dBµ emf (20 dB SINAD)
- Squelch sensitivity (at threshold, typical): -6 dBµ emf
- Intermodulation rejection ratio: 65 dB
- Spurious response rejection ratio: 65 dB
- Adjacent channel selectivity: 65 dB
- Audio output power (at 10% distortion with an 8 Ω load):  
0.2 W (External)  
0.7 W typical at 1 kHz (Internal)

**All stated specifications are subject to change without notice or obligation.**

# 14 VHF MARINE CHANNEL LIST

## ◇ For IC-M73EURO (Except for AUS)

### • International channels

CH	Frequency (MHz)		CH	Frequency (MHz)		CH	Frequency (MHz)		CH	Frequency (MHz)		CH	Frequency (MHz)		CH	Frequency (MHz)		CH	Frequency (MHz)	
	Transmit	Receive		Transmit	Receive		Transmit	Receive		Transmit	Receive		Transmit	Receive		Transmit	Receive		Transmit	Receive
01	156.050	160.650	11	156.550	156.550	2019	RX Only	161.550	27	157.350	161.950	66	156.325	160.925	77	156.875	156.875	83	157.175	161.775
02	156.100	160.700	12	156.600	156.600	20	157.000	161.600	28	157.400	162.000	67	156.375	156.375	78	156.925	161.525	84	157.225	161.825
03	156.150	160.750	13	156.650	156.650	1020	157.000	157.000	31 <sup>*1/3</sup>	157.550	162.150	68	156.425	156.425	1078	156.925	156.925	85	157.275	161.875
04	156.200	160.800	14	156.700	156.700	2020	RX Only	161.600	1037 <sup>*2</sup>	157.850	157.850	69	156.475	156.475	2078	RX Only	161.525	86	157.325	161.925
05	156.250	160.850	15 <sup>*1</sup>	156.750	156.750	21	157.050	161.650	60	156.025	160.625	71	156.575	156.575	79	156.975	161.575	87	157.375	157.375
06	156.300	156.300	16	156.800	156.800	22	157.100	161.700	61	156.075	160.675	72	156.625	156.625	1079	156.975	156.975	88	157.425	157.425
07	156.350	160.950	17 <sup>*1</sup>	156.850	156.850	23	157.150	161.750	62	156.125	160.725	73	156.675	156.675	2079	RX Only	161.575	P4 <sup>*4</sup>	161.425	161.425
08	156.400	156.400	18	156.900	161.500	24	157.200	161.800	63	156.175	160.775	74	156.725	156.725	80	157.025	161.625			
09	156.450	156.450	19	156.950	161.550	25	157.250	161.850	64	156.225	160.825	75 <sup>*1</sup>	156.775	156.775	81	157.075	161.675			
10	156.500	156.500	1019	156.950	156.950	26	157.300	161.900	65	156.275	160.875	76 <sup>*1</sup>	156.825	156.825	82	157.125	161.725			

\*1 Low power only.

\*2 For only the HOL and UK version (UK Marina Channel: M1=1037 (157.850 MHz) for U.K. version), and low power only for the HOL version.

\*3 For only the HOL version.

\*4 UK Marina Channel: M2=P4 (161.425 MHz) for U.K. version only.



## ◇ For IC-M73EURO (Only for UK)

## • USA channels

CH	Frequency (MHz)		CH	Frequency (MHz)		CH	Frequency (MHz)		CH	Frequency (MHz)		CH	Frequency (MHz)	
	Transmit	Receive		Transmit	Receive		Transmit	Receive		Transmit	Receive		Transmit	Receive
1001	156.050	156.050	15	RX only	156.750	25	157.250	161.850	71	156.575	156.575	84	157.225	161.825
1005	156.250	156.250	16	156.800	156.800	26	157.300	161.900	72	156.625	156.625	85	157.275	161.875
06	156.300	156.300	17*	156.850	156.850	27	157.350	161.950	73	156.675	156.675	86	157.325	161.925
1007	156.350	156.350	1018	156.900	156.900	28	157.400	162.000	74	156.725	156.725	87	157.375	157.375
08	156.400	156.400	1019	156.950	156.950	1037	157.850	157.850	77*	156.875	156.875	88	157.425	157.425
09	156.450	156.450	20	157.000	161.600	1063	156.175	156.175	1078	156.925	156.925	P4	161.425	161.425
10	156.500	156.500	1020	157.000	157.000	1065	156.275	156.275	1079	156.975	156.975			
11	156.550	156.550	1021	157.050	157.050	1066	156.325	156.325	1080	157.025	157.025			
12	156.600	156.600	1022	157.100	157.100	67*	156.375	156.375	1081	157.075	157.075			
13*	156.650	156.650	1023	157.150	157.150	68	156.425	156.425	1082	157.125	157.125			
14	156.700	156.700	24	157.200	161.800	69	156.475	156.475	1083	157.175	157.175			

\* Low power only.

**NOTE:** Simplex channels, 1021, 1023, 1081, 1082 and 1083 **CANNOT** be lawfully used by the general public in U.S.A. waters.

# 14 VHF MARINE CHANNEL LIST

## ◇ For IC-M73 and IC-M73EURO (AUS)

Channel number		Frequency (MHz)		
USA	INT	CAN	Transmit	Receive
	01	01	156.050	160.650
1001	1001 <sup>6</sup>		156.050	156.050
	02	02	156.100	160.700
	03	03	156.150	160.750
	04		156.200	160.800
		1004	156.200	156.200
			156.250	160.850
1005	1005 <sup>6</sup>	1005	156.250	156.250
06	06	06	156.300	156.300
	07		156.350	160.950
1007	1007 <sup>6</sup>	1007	156.350	156.350
08	08	08	156.400	156.400
09	09	09	156.450	156.450
10	10	10	156.500	156.500
11	11	11	156.550	156.550
12	12	12	156.600	156.600
13 <sup>*1</sup>	13	13 <sup>*1</sup>	156.650	156.650
14	14	14	156.700	156.700
15 <sup>*4</sup>	15 <sup>*3</sup>	15 <sup>*1</sup>	156.750	156.750
16	16	16	156.800	156.800
17 <sup>*1</sup>	17 <sup>*2</sup>	17 <sup>*1</sup>	156.850	156.850
	18		156.900	161.500
1018	1018 <sup>6</sup>	1018	156.900	156.900
	19		156.950	161.550
1019	1019	1019	156.950	156.950
	2019 <sup>6</sup>		161.550	161.550
20	20	20 <sup>*1</sup>	157.000	161.600
1020	1020		157.000	157.000

Channel number		Frequency (MHz)		
USA	INT	CAN	Transmit	Receive
	2020 <sup>6</sup>		161.600	161.600
	21		157.050	161.650
1021	1021 <sup>6</sup>	1021	157.050	157.050
		2021	RX only	161.650
	22		157.100	161.700
1022	1022 <sup>6</sup>	1022	157.100	157.100
	23	23	157.150	161.750
1023	1023 <sup>6</sup>		157.150	157.150
		2023	RX only	161.750
24	24 <sup>*7</sup>	24	157.200	161.800
25	25 <sup>*7</sup>	25	157.250	161.850
		2025	RX only	161.850
26	26 <sup>*7</sup>	26	157.300	161.900
27	27	27	157.350	161.950
	1027 <sup>6</sup>		157.350	157.350
28	28	28	157.400	162.000
	1028 <sup>6</sup>		157.400	157.400
		2028	RX only	162.000
	60	60	156.025	160.625
	61		156.075	160.675
		1061	156.075	156.075
	62		156.125	160.725
		1062	156.125	156.125
	63		156.175	160.775
1063	1063 <sup>6</sup>	1063	156.175	156.175
	64	64	156.225	160.825
		1064	156.225	156.225
	65		156.275	160.875

Channel number		Frequency (MHz)		
USA	INT	CAN	Transmit	Receive
1065	1065 <sup>6</sup>	1065 <sup>*1</sup>	156.275	156.275
	66		156.325	160.925
1066	1066 <sup>6</sup>	1066 <sup>*1</sup>	156.325	156.325
67 <sup>*1</sup>	67	67	156.375	156.375
68	68	68	156.425	156.425
69	69	69	156.475	156.475
71	71	71	156.575	156.575
72	72	72	156.625	156.625
73	73	73	156.675	156.675
74	74	74	156.725	156.725
	75 <sup>*3</sup>	75 <sup>*1</sup>	156.775	156.775
	76 <sup>*3</sup>	76 <sup>*1</sup>	156.825	156.825
77 <sup>*1</sup>	77	77 <sup>*1</sup>	156.875	156.875
	78		156.925	161.525
1078	1078	1078	156.925	156.925
	2078 <sup>6</sup>		161.525	161.525
	79		156.975	161.575
1079	1079	1079	156.975	156.975
	2079 <sup>6</sup>		162.575	162.575
	80		157.025	161.625
1080	1080 <sup>6</sup>	1080	157.025	157.025
	81		157.075	161.675
1081	1081 <sup>6</sup>	1081	157.075	157.075
	82		157.125	161.725
1082	1082 <sup>6</sup>	1082	157.125	157.125
	83		157.175	161.775
1083	1083 <sup>6</sup>	1083	157.175	157.175
		2083	RX only	161.775

Channel number		Frequency (MHz)		
USA	INT	CAN	Transmit	Receive
84	84 <sup>*7</sup>	84	157.225	161.825
85	85 <sup>*7</sup>	85	157.275	161.875
86	86 <sup>*7</sup>	86	157.325	161.925
87	87	87	157.375	157.375
88	88	88	157.425	157.425

NOTE: Simplex channels, 1021, 1023, 1081, 1082 and 1083 **CAN-NOT** be lawfully used by the general public in U.S.A. waters.

- \*1 Low power only.
- \*2 Low power only for the CHN version.
- \*3 Low power only (Except for the AUS version).
- \*4 RX only.
- \*5 RX only (Except for the CHN version).
- \*6 For only the USA and EXP version.
- \*7 For only the AUS and CHN version.

## ◇ BATTERY CASE AND PACK

- **BP-245H** Li-ion BATTERY PACK

The same as supplied with the transceiver.

Voltage : 7.2 V

Capacity : 2150 mAh (minimum)/2200 mAh (typical)

## ◇ CHARGERS

- **BC-210** DESKTOP CHARGER + **BC-123SA/SE/SV** AC ADAPTER

For rapid charging of battery packs. The same as supplied with the transceiver. An AC adapter is supplied with the charger depending on versions.

Charging time: Approximately 3 hours

- **BC-197** MULTI-CHARGER + **AD-129** CHARGER ADAPTER (6 pcs.) + **BC-157S** AC ADAPTER

For rapid charging of up to 6 battery packs (six AD-129's are required) simultaneously. An AC adapter should be purchased separately.

Charging time: Approximately 3 hours.

## ◇ DC CABLES

- **CP-25H** CIGARETTE LIGHTER CABLE

The same as supplied with some of the transceiver versions.

Specification: 12 V DC/1 A

**NOTE:** The CP-25H is equipped with a 2 A fuse. If the fuse blows, replace it with a new rated fuse. **DO NOT** use a fuse with amp ratings other than this rating.

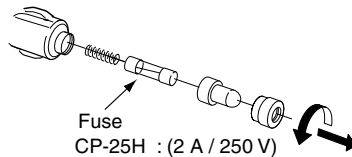

- **OPC-515L/OPC-656** DC POWER CABLES

Charges the battery pack using 13.8 V power source instead of the AC adapter.

OPC-515L: For BC-210

OPC-656 : For BC-197

## ◇ BELT CLIPS

- **MB-103** BELT CLIP

The same as supplied with the transceiver.

- **MB-86** SWIVEL BELT CLIP

Belt clip for swivel type.

- **MB-96N/MB-96F/MB-96FL** LEATHER BELT HANGER

## ◇ OTHER OPTIONS

- **HM-167** SPEAKER-MICROPHONE

Full sized waterproof speaker-microphone including alligator type clip to attach to your shirt or collar, etc.

- **HM-202** SPEAKER-MICROPHONE

The HM-202 meets IP67 requirements for waterproof protection. Once the item has been dropped, the waterproof protection cannot be guaranteed because of possible damage to the case or the waterproof seals.

- **FA-S59V\*/FA-S64V** FLEXIBLE ANTENNAS

\*Except for the AUS version.

# 16 INFORMATIONS

## ■ FCC INFORMATION

This equipment has been tested and found to comply with the limits for a Class A digital device, pursuant to part 15 of the FCC Rules. These limits are designed to provide reasonable protection against harmful interference when the equipment is operated in a commercial environment. This equipment generates, uses, and can radiate radio frequency energy and, if not installed and used in accordance with the instruction manual, may cause harmful interference to radio communications. Operation of this equipment in a residential area is likely to cause harmful interference in which case the user will be required to correct the interference at his own expense.

**CAUTION:** Changes or modifications to this device, not expressly approved by Icom Inc., could void your authority to operate this device under FCC regulations.

## ■ ABOUT CE AND DOC

 Hereby, Icom Inc. declares that the versions of IC-M73 EURO which have the “CE” symbol on the product, comply with the essential requirements of the Radio Equipment Directive, 2014/53/EU, and the restriction of the use of certain hazardous substances in electrical and electronic equipment Directive, 2011/65/EU. The full text of the EU declaration of conformity is available at the following internet address: <https://www.icomjapan.com/support/>

## ■ INFORMATION FCC

Cet équipement a été testé et reconnu conforme aux limites fixées pour un appareil numérique de classe A, conformément au point 15 de la réglementation FCC. Ces limites sont définies de façon à fournir une protection raisonnable contre le brouillage préjudiciable lorsque cet appareil est utilisé dans un environnement commercial. Cet équipement génère, utilise et peut émettre un rayonnement de fréquence radio. S’il n’a pas été installé conformément aux instructions, il peut par ailleurs créer des interférences perturbant les communications radio. L’utilisation de cet appareil dans une zone résidentielle peut provoquer un brouillage préjudiciable, auquel cas l’utilisateur sera tenu de corriger la situation à ses frais.

**MISE EN GARDE :** Tout changement ou modification, non expressément approuvé par Icom Inc., peut annuler l’autorisation de l’utilisateur à utiliser cet appareil conformément à la réglementation FCC.

## ■ DISPOSAL



The crossed-out wheeled-bin symbol on your product, literature, or packaging reminds you that in the European Union, all electrical and electronic products, batteries, and accumulators (rechargeable batteries) must be taken to designated collection locations at the end of their working life. Do not dispose of these products as unsorted municipal waste. Dispose of them according to the laws in your area.

**- A -**

ABOUT CE AND DOC ..... 44

About the function mode ..... 17

AD-129 installation ..... 34

Adjusting the squelch level ..... 13

AquaQuake water draining function ..... 13

ATIS code confirmation ..... 23

ATIS code programming ..... 23

Attaching ..... 35, 36

Attachments ..... 2

Automatic recording function ..... 19

Automatic recording threshold level ..... 30

Auto power save function ..... 28

Auto scan function ..... 27

**- B -**

Backlight function ..... 24, 27

BASIC OPERATION ..... 8

BATTERY CASE AND PACK ..... 43

Battery caution ..... 31

BATTERY CHARGING ..... 31

Battery pack ..... 3

BC-210 installation ..... 33

Beep tone function ..... 26

Belt clip ..... 3, 43

**- C -**

Call channel ..... 8

Call channel programming ..... 12

Channel 16 ..... 8

Channel name programming ..... 21

Channel name scroll type ..... 28

Channel naming function ..... 21

Channel selection ..... 8

CHARGERS ..... 43

Charging ..... 33

Charging caution ..... 32

**- D -**

DC CABLES ..... 43

Description ..... 16

Detaching ..... 35

DISPOSAL ..... 44

Dual/Tri-watch function ..... 27

DUALWATCH/TRI-WATCH ..... 16

**- E -**

Entering the function mode ..... 17

EXPLICIT DEFINITIONS ..... i

**- F -**

FCC INFORMATION ..... 44

Flexible antenna ..... 2

Front, top and side panels ..... 4

Function display ..... 6

FUNCTION MODE ITEMS ..... 17

FUNCTION MODE OPERATION ..... 17

**- G -**

General ..... 38, 39

**- H -**

Handstrap ..... 2

HM-167 descriptions ..... 36

**- I -**

IMPORTANT ..... i

IN CASE OF EMERGENCY ..... vi

INFOMATION EN MATIÈRE DE SÉCURITÉ ..... v

INFORMATION FCC ..... 44

**- L -**

LCD contrast selection ..... 28

Lock function ..... 12

# INDEX

	<b>- M -</b>	
Manual recording function .....	18	
Monitor function .....	12	
Monitor key action.....	27	
	<b>- N -</b>	
NORMAL SCAN .....	14	
	<b>- O -</b>	
Opening comment entry function .....	22	
Opening comment programming.....	22	
OPERATING RULES .....	1	
Operation.....	16	
Optional battery chargers .....	34	
OPTIONAL SPEAKER-MICROPHONE .....	36	
OPTIONAL SWIVEL BELT CLIP .....	35	
OPTIONS .....	43	
OTHER OPTIONS.....	43	
	<b>- P -</b>	
PANEL DESCRIPTION.....	4	
Play back function.....	20	
PRECAUTIONS.....	ii	
PRÉCAUTIONS.....	iii	
Priorities .....	1	
PRIORITY SCAN.....	14	
Priority scan function .....	26	
Privacy.....	1	
	<b>- R -</b>	
Radio licenses .....	1	
Rapid charging with the BC-197+BC-157S or OPC-656 .....	34	
Receiver .....	38, 39	
Receiving and transmitting .....	11	
RECOMMENDATION .....	vi	
		RX bass boost function.....29
		RX Noise Cancel function.....29
	<b>- S -</b>	
	SAFETY TRAINING INFORMATION.....	iv
	SCAN OPERATION.....	14
	Scan resume timer .....	26
	Scan types.....	14
	Scrolling speed.....	28
	SET MODE.....	25
	SET MODE ITEMS.....	25, 26
	SET mode operation.....	25
	SET mode programming .....	25
	Setting Favorite channels .....	15
	SPECIFICATIONS .....	38
	Starting a scan .....	15
	Supplied accessories.....	2
	SUPPLIED ACCESSORIES AND ATTACHMENTS .....	2
	Supplied battery charger .....	33
	<b>- T -</b>	
	Transmitter.....	38, 39
	TROUBLESHOOTING.....	37
	TX bass boost function.....	29
	TX Noise Cancel function .....	29
	<b>- U -</b>	
	Usable characters.....	21
	U.S.A., International, Canadian and ATIS channels .....	9
	<b>- V -</b>	
	VHF MARINE CHANNEL LIST.....	40
	<b>- W -</b>	
	Weather alert function .....	26
	Weather channels.....	10

---

MEMO

---

---

---

---

---

---

---

---

---

---

---

---

---

---

---

---

**Count on us!**

A7070D-1EX-11  
Printed in Japan  
© 2013–2021 Icom Inc.    Apr. 2021

**Icom Inc.**  
1-1-32 Kamiminami, Hirano-ku, Osaka 547-0003, Japan