

CP100 / CP200

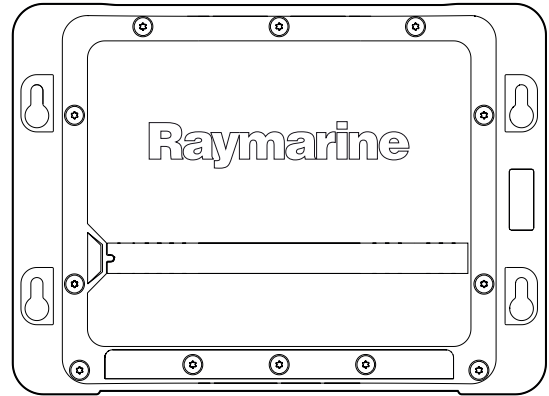

Installation instructions

English

Date: 07-2014

Document number: 87216-1-EN

© 2014 Raymarine UK Limited

Trademark and patents notice

Raymarine, Tacktick, Clear Pulse, Truzoom, HSB, SeaTalk, SeaTalk^{hs}, SeaTalk^{ng}, Micronet, Raytech, Gear Up, Marine Shield, Seahawk, Autohelm, Automagic, and Visionality are registered or claimed trademarks of Raymarine Belgium.

FLIR, DownVision, SideVision, Dragonfly, Instalert, Infrared Everywhere, and The World's Sixth Sense are registered or claimed trademarks of FLIR Systems, Inc.

All other trademarks, trade names, or company names referenced herein are used for identification only and are the property of their respective owners.

This product is protected by patents, design patents, patents pending, or design patents pending.

Patents pending

Important: This product has patents pending.

Fair Use Statement

You may print no more than three copies of this manual for your own use. You may not make any further copies or distribute or use the manual in any other way including without limitation exploiting the manual commercially or giving or selling copies to third parties.

Software updates

Check the website www.raymarine.com for the latest software releases for your product.

Product handbooks

The latest versions of all English and translated handbooks are available to download in PDF format from the website www.raymarine.com.

Please check the website to ensure you have the latest handbooks.

Copyright ©2014 Raymarine UK Ltd. All rights reserved.

Contents

Chapter 1 Important information.....	7	6.6 Resetting the sonar module	43
Certified Installation	7	Chapter 7 Maintenance	45
Water ingress	8	7.1 Routine checks	46
Disclaimer	8	7.2 Unit cleaning instructions.....	46
EMC installation guidelines	8	7.3 Transducer care and cleaning.....	47
Suppression ferrites	8	Chapter 8 Technical support	49
Connections to other equipment	8	8.1 Raymarine customer support	50
Declaration of conformity.....	8	8.2 Viewing product information	50
Product disposal.....	8	Chapter 9 Technical specification.....	51
Warranty registration.....	8	9.1 Technical specification.....	52
IMO and SOLAS.....	9	Chapter 10 Spares and accessories	53
Technical accuracy	9	10.1 Spares and accessories.....	54
Chapter 2 Document and product information.....	11	10.2 Network hardware	54
2.1 Document information	12	10.3 Network cable connector types.....	55
2.2 Parts supplied	13	10.4 RayNet to RayNet cables and connectors	56
2.3 Product overview	14	10.5 RayNet to RJ45 adapter cables.....	57
2.4 CHIRP Sonar overview.....	15	10.6 SeaTalk ^{ng} cables and accessories	58
2.5 CHIRP DownVision™ overview.....	15		
2.6 CHIRP SideVision ™ overview	16		
2.7 Interpreting SideVision ™ images	17		
2.8 CHIRP DownVision ™ and CHIRP SideVision ™ combined	18		
Chapter 3 Planning the installation	19		
3.1 Installation checklist	20		
3.2 Required additional components	20		
3.3 Compatible multifunction displays	21		
3.4 Software updates	21		
3.5 Compatible transducers.....	22		
3.6 Tools required	22		
3.7 Typical systems	23		
3.8 Warnings and cautions	24		
3.9 General location requirements	24		
3.10 Product dimensions.....	25		
Chapter 4 Cables and connections.....	27		
4.1 General cabling guidance	28		
4.2 Connections overview	29		
4.3 Power connection	29		
4.4 Transducer connections	31		
4.5 Network connection.....	32		
Chapter 5 Mounting.....	35		
5.1 Mounting	36		
Chapter 6 System checks and troubleshooting	37		
6.1 Initial power on test	38		
6.2 Troubleshooting	38		
6.3 Sonar troubleshooting	39		
6.4 Sonar crosstalk interference	40		
6.5 LED indications.....	42		

Chapter 1: Important information

Certified Installation

Raymarine recommends certified installation by a Raymarine approved installer. A certified installation qualifies for enhanced product warranty benefits. Contact your Raymarine dealer for further details, and refer to the separate warranty document packed with your product.



Warning: Product installation and operation

This product must be installed and operated in accordance with the instructions provided. Failure to do so could result in personal injury, damage to your vessel and/or poor product performance.



Warning: Potential ignition source

This product is NOT approved for use in hazardous/flammable atmospheres. Do NOT install in a hazardous/flammable atmosphere (such as in an engine room or near fuel tanks).



Warning: Product grounding

Before applying power to this product, ensure it has been correctly grounded, in accordance with the instructions in this guide.



Warning: Positive ground systems

Do not connect this unit to a system which has positive grounding.



Warning: Power supply voltage

Connecting this product to a voltage supply greater than the specified maximum rating may cause permanent damage to the unit. Refer to the *Technical specification* section for voltage rating.



Warning: Switch off power supply

Ensure the vessel's power supply is switched OFF before starting to install this product. Do NOT connect or disconnect equipment with the power switched on, unless instructed in this document.

Caution: Power supply protection

When installing this product ensure the power source is adequately protected by means of a suitably-rated fuse or automatic circuit breaker.



Warning: Ensure all equipment has isolated power supply

This product features an isolated power supply. To prevent potential damage to equipment, Raymarine recommends that any external equipment connected to this product also features an isolated power supply.



Warning: High voltage

This product contains high voltage. Adjustments require specialized service procedures and tools only available to qualified service technicians. There are no user serviceable parts or adjustments. The operator should never remove the cover or attempt to service the product.



Warning: Transducer cables

Do not remove the transducer cable whilst the product is powered on, doing so can cause sparks. If the transducer cable is accidentally removed whilst the product is powered on, switch the product's power off, replace the cable and then switch the power back on.



Warning: Sonar operation

- NEVER operate the sonar with the vessel out of the water.
- NEVER touch the transducer face when the sonar is powered on.
- SWITCH OFF the sonar if divers are likely to be within 7.6 m (25 ft) of the transducer.

Caution: Do not cut transducer cables

- Cutting the transducer cable severely reduces sonar performance. If the cable is cut, it must be replaced, it cannot be repaired.
- Cutting the transducer cable will void the warranty and invalidate the European CE mark.

Caution: Service and maintenance

This product contains no user serviceable components. Please refer all maintenance and repair to authorized Raymarine dealers. Unauthorized repair may affect your warranty.

Water ingress

Water ingress disclaimer

Although the waterproof rating capacity of this product meets the stated IPX standard (refer to the product's *Technical Specification*), water intrusion and subsequent equipment failure may occur if the product is subjected to commercial high-pressure washing. Raymarine will not warrant products subjected to high-pressure washing.

Disclaimer

Raymarine does not warrant that this product is error-free or that it is compatible with products manufactured by any person or entity other than Raymarine.

Raymarine is not responsible for damages or injuries caused by your use or inability to use the product, by the interaction of the product with products manufactured by others, or by errors in information utilized by the product supplied by third parties.

EMC installation guidelines

Raymarine equipment and accessories conform to the appropriate Electromagnetic Compatibility (EMC) regulations, to minimize electromagnetic interference between equipment and minimize the effect such interference could have on the performance of your system

Correct installation is required to ensure that EMC performance is not compromised.

Note: In areas of extreme EMC interference, some slight interference may be noticed on the product. Where this occurs the product and the source of the interference should be separated by a greater distance.

For **optimum** EMC performance we recommend that wherever possible:

- Raymarine equipment and cables connected to it are:
 - At least 1 m (3 ft) from any equipment transmitting or cables carrying radio signals e.g. VHF radios, cables and antennas. In the case of SSB radios, the distance should be increased to 7 ft (2 m).
 - More than 2 m (7 ft) from the path of a radar beam. A radar beam can normally be assumed to spread 20 degrees above and below the radiating element.
- The product is supplied from a separate battery from that used for engine start. This is important to prevent erratic behavior and data loss which can occur if the engine start does not have a separate battery.
- Raymarine specified cables are used.
- Cables are not cut or extended, unless doing so is detailed in the installation manual.

Note: Where constraints on the installation prevent any of the above recommendations, always ensure the maximum possible separation between different items of electrical equipment, to provide the best conditions for EMC performance throughout the installation

Suppression ferrites

Raymarine cables may be fitted with suppression ferrites. These are important for correct EMC performance. If a ferrite has to be removed for any purpose (e.g. installation or maintenance), it must be replaced in the original position before the product is used.

Use only ferrites of the correct type, supplied by Raymarine authorized dealers.

Where an installation requires multiple ferrites to be added to a cable, additional cable clips should be used to prevent stress on the connectors due to the extra weight of the cable.

Connections to other equipment

Requirement for ferrites on non-Raymarine cables

If your Raymarine equipment is to be connected to other equipment using a cable not supplied by Raymarine, a suppression ferrite **MUST** always be attached to the cable near the Raymarine unit.

Declaration of conformity

Raymarine UK Ltd. declares that this product is compliant with the essential requirements of EMC directive 2004/108/EC.

The original Declaration of Conformity certificate may be viewed on the relevant product page at www.raymarine.com.

Product disposal

Dispose of this product in accordance with the WEEE Directive.



The Waste Electrical and Electronic Equipment (WEEE) Directive requires the recycling of waste electrical and electronic equipment. Whilst the WEEE Directive does not apply to some Raymarine products, we support its policy and ask you to be aware of how to dispose of this product.

Warranty registration

To register your Raymarine product ownership, please visit www.raymarine.com and register online.

It is important that you register your product to receive full warranty benefits. Your unit package includes a bar code label indicating the serial number

of the unit. You will need this serial number when registering your product online. You should retain the label for future reference.

IMO and SOLAS

The equipment described within this document is intended for use on leisure marine boats and workboats NOT covered by International Maritime Organization (IMO) and Safety of Life at Sea (SOLAS) Carriage Regulations.

Technical accuracy

To the best of our knowledge, the information in this document was correct at the time it was produced. However, Raymarine cannot accept liability for any inaccuracies or omissions it may contain. In addition, our policy of continuous product improvement may change specifications without notice. As a result, Raymarine cannot accept liability for any differences between the product and this document. Please check the Raymarine website (www.raymarine.com) to ensure you have the most up-to-date version(s) of the documentation for your product.

Chapter 2: Document and product information

Chapter contents

- 2.1 Document information on page 12
- 2.2 Parts supplied on page 13
- 2.3 Product overview on page 14
- 2.4 CHIRP Sonar overview on page 15
- 2.5 CHIRP DownVision™ overview on page 15
- 2.6 CHIRP **SideVision™** overview on page 16
- 2.7 Interpreting **SideVision™** images on page 17
- 2.8 CHIRP **DownVision™** and CHIRP **SideVision™** combined on page 18

2.1 Document information

This document contains important information related to the installation of your Raymarine product.



The document includes information to help you:

- plan your installation and ensure you have all the necessary equipment;
- install and connect your product as part of a wider system of connected marine electronics;
- troubleshoot problems and obtain technical support if required.

This and other Raymarine product documents are available to download in PDF format from www.raymarine.com.

Applicable products

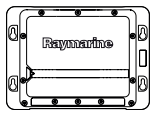
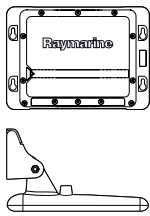
This document is applicable to the following products:

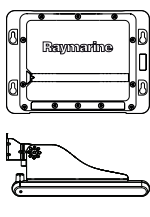
	Part number	Name	Description
	E70204	CP100	2-channel CHIRP / DownVision sonar module
	E70205	CP100 and CPT-100	2-channel CHIRP / DownVision sonar module and DownVision transom transducer.
	E70256	CP200	2-channel CHIRP / SideVision sonar module
	E70257	CP200 and CPT-200	2-channel CHIRP / SideVision sonar module and SideVision transom transducer.

Document conventions

The following conventions are used throughout this document when referring to:

Type	Example	Convention
Procedures for performing specific tasks using a multifunction display.	Select Transducer Set-Up .	The term “Select” is used to refer to the action of selecting a menu option on a multifunction display, using the touchscreen or physical controls, depending on display variant.
Procedures for navigating menu hierarchies on a multifunction display.	Internal sonar module is turned off from the Fishfinder application menu: Menu > Set-up > Sounder Set-up > Internal Sounder .	Menu hierarchies are used in this document to provide a quick summary on how to access a particular function on the multifunction display.

Document illustrations

Your product may differ slightly from that shown in the illustrations in this document, depending on product variant and date of manufacture.

All images are provided for illustration purposes only.

Product documentation

The following documentation is applicable to your product:

Description	Part number
CP100 / CP200 Installation instructions Installation of a CP100 or CP200 unit and connection to a wider system of marine electronics.	87216 / 88030
CP100 / CP200 Mounting template Mounting diagram for surface mounting a CP100 or CP200 unit.	87193
CPT-60 / CPT-100 DownVision transom transducer Installation instructions Installation of a DownVision transom-mount transducer.	87197 / 88024
CPT-200 SideVision transom transducer Installation instructions Installation of a SideVision transom-mount transducer.	87223 / 88037
CPT-110 / CPT-120 Through-hull transducer Installation instructions Installation of a DownVision through-hull transducer.	87201 / 88025

Description	Part number
a Series, c Series, e Series Installation and operation instructions Details the operation of the fishfinder application (including DownVision and SideVision operation) for a Series, c Series, e Series multifunction displays.	81337
gS Series Installation and operation instructions Details the operation of the fishfinder application (including DownVision and SideVision operation) for gS Series multifunction displays.	81344

Operation instructions

For detailed operation instructions for your product, refer to the documentation that accompanies your display.

Transducer installation instructions

This document includes installation instructions for the sonar module only. For installation instructions for a connected transducer, please refer to the documentation that accompanies the transducer.

2.2 Parts supplied

Parts supplied — CP100 / CP200

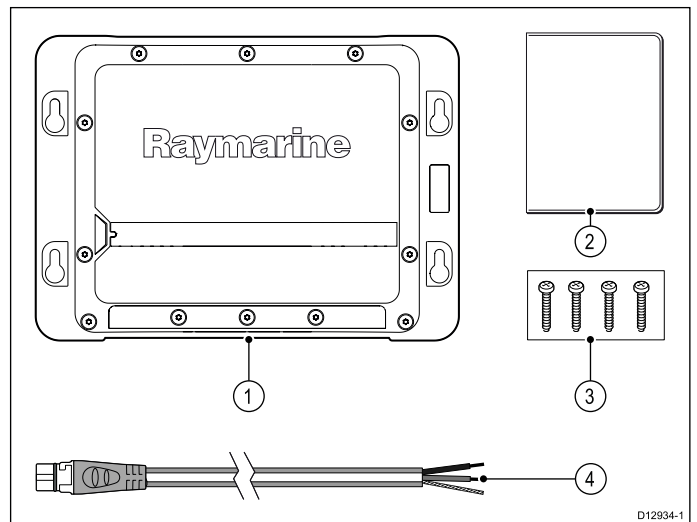

Item	Description	Quantity
1	Sonar module.	1
2	Documentation pack.	1
3	Mounting screws.	4
4	Power cable 1 m (3.28 ft).	1

2.3 Product overview

CP100 product overview

The CP100 is a CHIRP sonar module with **DownVision** capabilities. In conjunction with a compatible multifunction display, the CP100 provides a detailed view of the water's bottom structure, enabling you to identify fish and other objects in the water underneath your vessel.

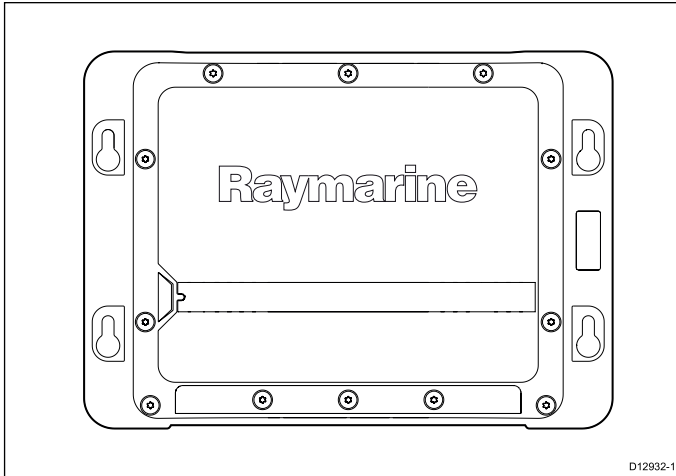

- Dual-beam sonar (port and starboard fan beam).
- Typical range performance of 300 ft.
- Water temperature sensing.
- Support for transom-mount **SideVision** transducers.
- Low power consumption.
- 12 V or 24 V operation.
- Waterproof to IPX 6 and IPX 7.
- Robust and waterproof high-speed network connection.

The CP100 has the following features:

- Dual-beam sonar (conical beam and fan beam).
- Typical depth performance of 600 ft.
- Water temperature sensing.
- Support for transom or through-hull **DownVision** transducers.
- Low power consumption.
- 12 V or 24 V operation.
- Waterproof to IPX 6 and IPX 7.
- Robust and waterproof high-speed network connection.

CP200 product overview

The CP200 is a CHIRP sonar module with **SideVision** capabilities. In conjunction with a compatible multifunction display, the CP200 provides a detailed view of the water's bottom structure on each side of your vessel, enabling you to identify bottom features, as well as fish and other objects in the water.

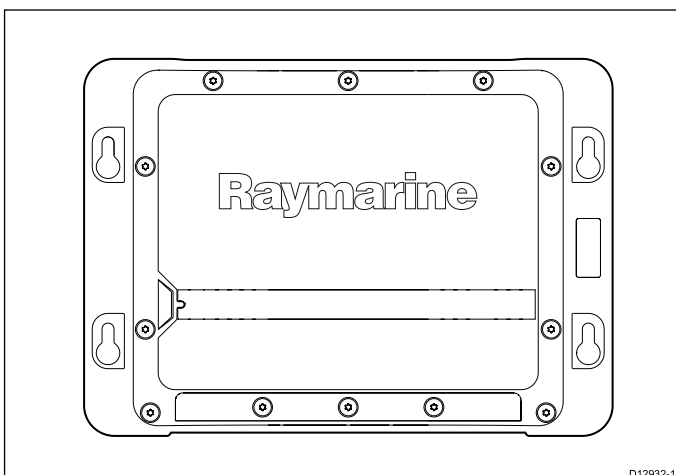

The CP200 has the following features:

2.4 CHIRP Sonar overview

CHIRP sonar produces a conical shaped beam, the coverage of the conical beam is the water column directly beneath the vessel

Conical beam

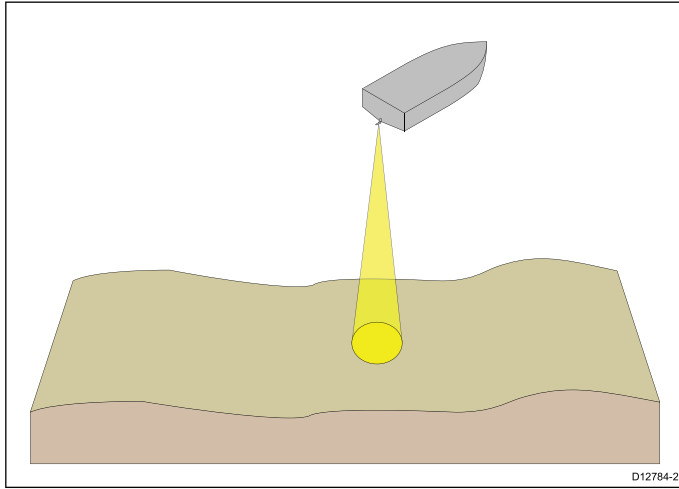

Sonar is effective at a range of speeds. In deeper waters the CHIRP bandwidth is automatically optimized to improve bottom lock and the detection of moving objects (e.g. fish) in the wider water column.

CHIRP sonar screen example

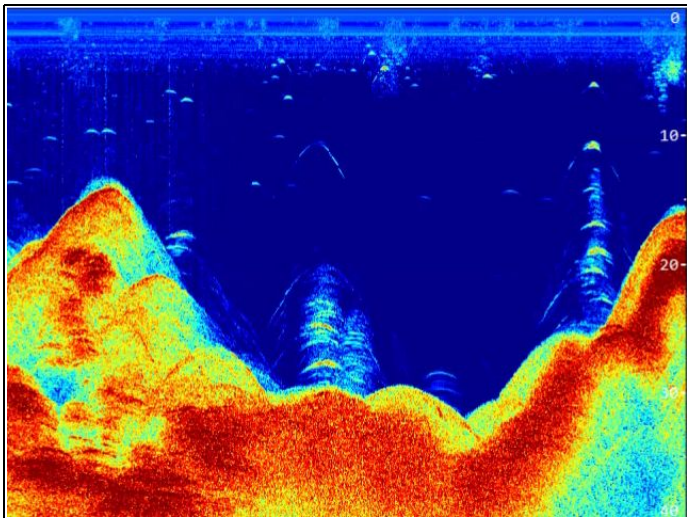

2.5 CHIRP DownVision™ overview

DownVision™ produces a wide-angle side-to-side beam and a thin fore-to-aft beam. The coverage of the DownVision™ beam is a water column directly beneath and to the sides of the vessel.

DownVision™ beam

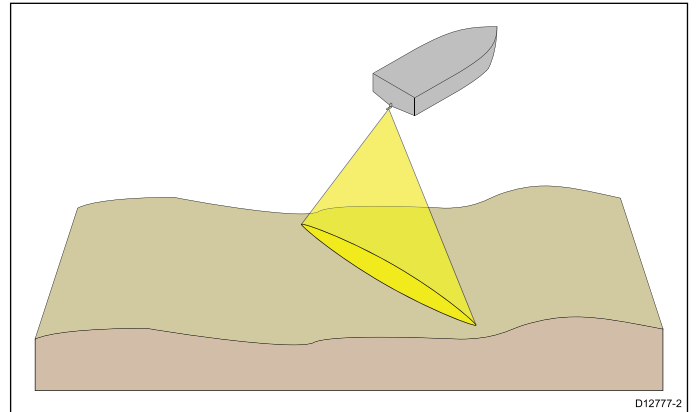

DownVision™ is effective at lower vessel speeds. In deeper waters the CHIRP bandwidth is automatically optimized to improve bottom lock and the detection of moving objects (e.g. fish) in the wider water column.

The wide, thin beam produces clear target returns. The use of CHIRP processing and a higher operating frequency provide a more detailed image, making it easier to identify bottom structures around which fish may reside.

CHIRP DownVision™ screen example

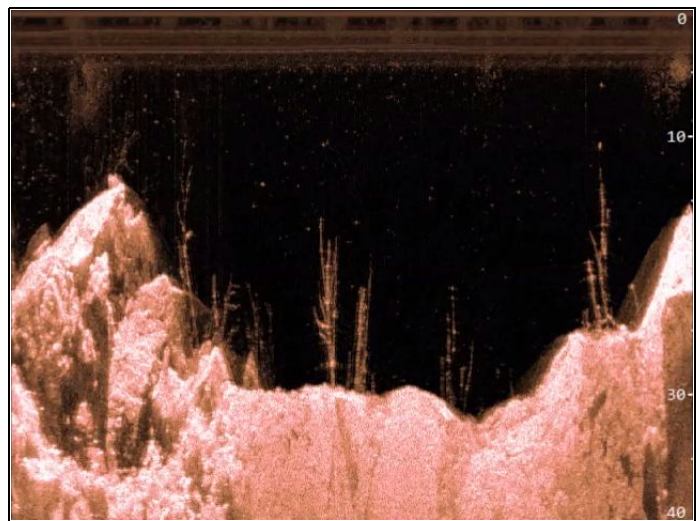

2.6 CHIRP SideVision™ overview

SideVision™ interprets signals from a pair of side-looking transducers and builds up a detailed underwater view as your vessel moves forward. The transducers send pulses of sound waves into the water on each side of your vessel, and record the sound waves that reflect off the bottom, and off objects on the bottom or suspended in the water column. The received echoes are affected by the bottom material (for example mud, gravel or rock), and by any other objects in their path (for example cables on the sea floor, bridge piers, wrecks, shoals or fish).

SideVision™ produces two wide-angle side-to-side beams, each with a thin fore-to-aft beam. The coverage of the **SideVision™** beams is a swath on each side of the vessel.

SideVision beams

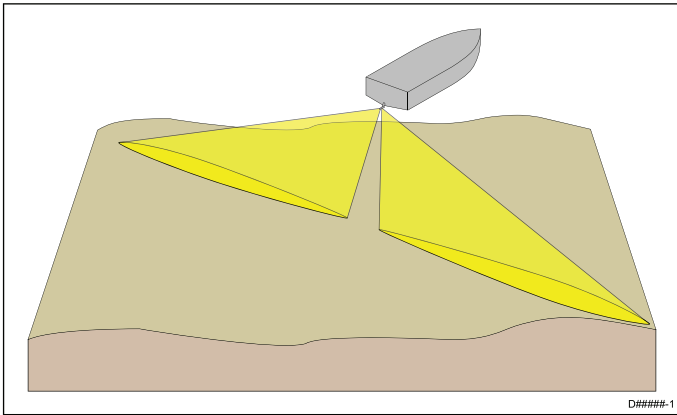

SideVision™ is effective at lower vessel speeds. The wide, thin beams produce clear target returns. As your vessel moves forward, subsequent returns build up to provide an image of the sea floor on each side of your vessel.

The use of CHIRP processing and a high operating frequency provide a detailed image, making it easier to identify bottom structures around which fish may reside. The narrow angle the beams make with the bottom at longer ranges can reveal the shadows of structures that protrude from the bottom.

CHIRP SideVision™ screen example

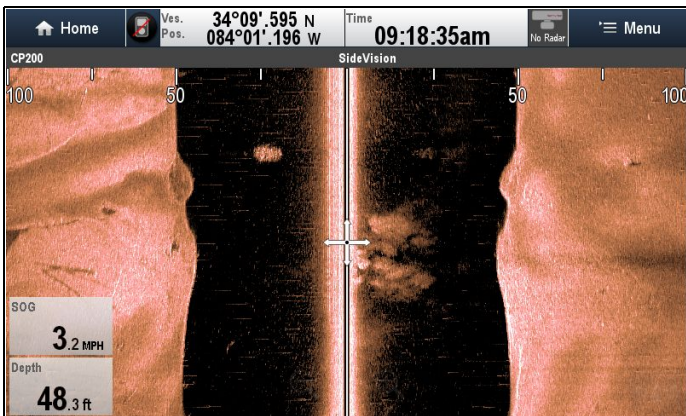

Note: The “Depth” figure shown in the illustration above assumes that you have a device in your system that provides depth data. Please be aware that not all transducers and / or sonar modules support depth sensing. For more information, refer to the latest specifications and documentation available for your particular products on the Raymarine website (www.raymarine.com).

2.7 Interpreting SideVision™ images

The following illustration shows how **SideVision™** images on your multifunction display are related to the water column and sea floor to the sides of your vessel.

Interpreting SideVision images

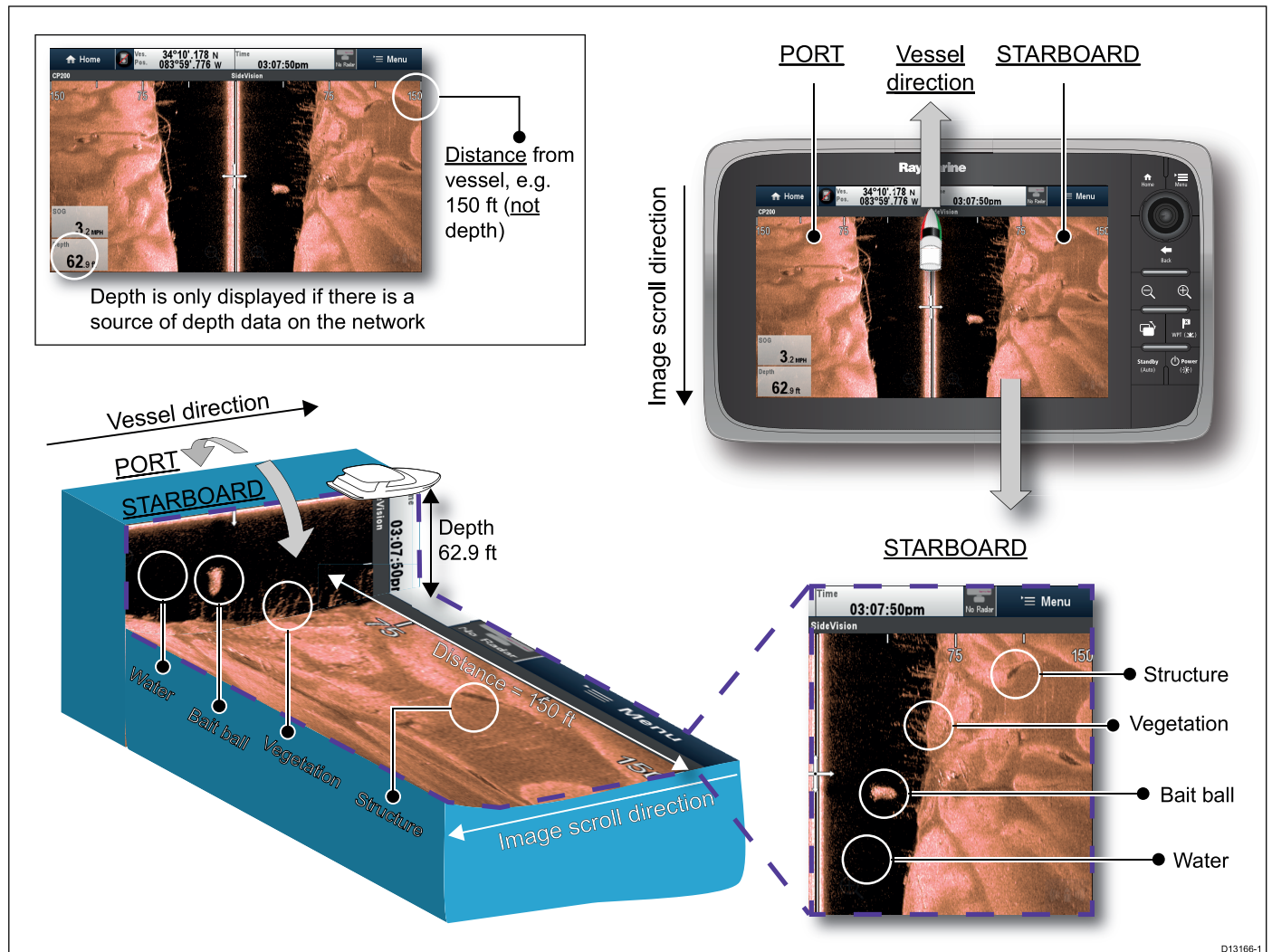

SideVision™ images are constructed line-by-line, similar to the way a television picture is composed of many horizontal lines. Each successive ping from the **SideVision™** transducer adds a new line of image data to the top of your display. Each new line shows sonar returns from both the port and starboard sides of your vessel.

As new lines are added with each successive ping, older data gradually scrolls down the display, building up a detailed image of the water column and sea floor to the sides of your vessel. If your vessel maintains the same bearing and speed for a period of time, you can interpret the image as a plan of the sea floor along your vessel's course.

The illustration also identifies examples of features that may be visible in **SideVision™** images:

- **Water:** close to your vessel, the **SideVision™** sonar beams may not interact with any solid objects in the water column until they hit the sea floor. The water column close to your vessel is displayed as a dark band in the image. The abrupt change to a lighter section in the image indicates where the sea floor is first detected with each ping.
- **Bait ball:** objects in the water column close to your vessel may be detected before the **SideVision™** beams hit the sea floor. In this example, a bait ball

is shown within the water column, at a distance of approximately 30 feet from the vessel.

- **Vegetation:** objects in contact with the sea floor that are close to your vessel may be clearly visible in the image at the point where the **SideVision™** beams hit the sea floor. In this example, the shapes in the image indicate vegetation attached to the sea floor.
- **Structure:** the lighter regions of the **SideVision™** image represent the sea floor. It may be possible to detect differences in the bottom material (for example, where an area of mud meets an area of gravel) as well as solid structures such as pipelines and piers. Larger solid structures, and sea floor relief, may reveal an area of shadow directed away from your vessel.

Note: Unlike **DownVision™**, **SideVision™** does not provide direct depth readings. The scale shown across the top of the image indicates the **distance** of features from your vessel.

2.8 CHIRP DownVision™ and CHIRP SideVision™ combined

By installing and operating **DownVision™** and **SideVision™** sonar systems simultaneously, you can achieve a full 180 degree view of the water column directly beneath and to the sides of your vessel.

DownVision and SideVision combined beams



Note: Using **DownVision™** and **SideVision™** together requires two separate sounders in your system:

1. A **DownVision™** sounder: either an internal sounder in a **DownVision™** variant multifunction display, or an external **DownVision™** sonar module (such as a CP100).
2. An external **SideVision™** sonar module (such as a CP200).

Chapter 3: Planning the installation

Chapter contents

- [3.1 Installation checklist on page 20](#)
- [3.2 Required additional components on page 20](#)
- [3.3 Compatible multifunction displays on page 21](#)
- [3.4 Software updates on page 21](#)
- [3.5 Compatible transducers on page 22](#)
- [3.6 Tools required on page 22](#)
- [3.7 Typical systems on page 23](#)
- [3.8 Warnings and cautions on page 24](#)
- [3.9 General location requirements on page 24](#)
- [3.10 Product dimensions on page 25](#)

3.1 Installation checklist

Installation includes the following activities:

Installation Task	
1	Plan your system.
2	Obtain all required equipment and tools.
3	Site all equipment.
4	Route all cables.
5	Drill cable and mounting holes.
6	Make all connections into equipment.
7	Secure all equipment in place.
8	Power on and test the system.

Schematic diagram

A schematic diagram is an essential part of planning any installation. It is also useful for any future additions or maintenance of the system. The diagram should include:

- Location of all components.
- Connectors, cable types, routes and lengths.

3.2 Required additional components

This product forms part of a system of electronics and requires the following additional components for full operation.

- Compatible transducer; transom or through-hull mount. Refer to [3.5 Compatible transducers](#) for a list of compatible products.
- Compatible Raymarine multifunction display. Refer to [3.3 Compatible multifunction displays](#) for a list of compatible products.
- Data cables. Refer to [Chapter 4 Cables and connections](#) for suitable cables. Some installations may also require extensions to data, power or transducer cables. Refer to the [Chapter 4 Cables and connections](#) and [Chapter 10 Spares and accessories](#) sections for more information.

3.3 Compatible multifunction displays

This product is compatible with the following LightHouse powered Raymarine multifunction displays.

- a Series, c Series, e Series.
- gS Series.

Multifunction display software requirements

The operation of this product requires that your Raymarine LightHouse powered MFD is running LightHouse software version 11 or later.

Note: The latest MFD software can be obtained by visiting www.raymarine.com/software.

3.4 Software updates

The software running on the product can be updated.

- Raymarine periodically releases software updates to improve product performance and add new features.
- You can update the software for your product using a connected and compatible multifunction display.
- Refer to www.raymarine.com/software/ for the latest software updates and the software update procedure for your product.
- If in doubt as to the correct procedure for updating your product software, refer to your dealer or Raymarine technical support.

Caution: Downloading software updates

The software update process is carried out at your own risk. Before initiating the update process ensure you have backed up any important files.

Ensure that the unit has a reliable power supply and that the update process is not interrupted.

Damage caused by incomplete updates are not covered by Raymarine warranty.

By downloading the software update package, you agree to these terms.

3.5 Compatible transducers

CP100 compatible transducers

This product is compatible with the following Raymarine transducers.

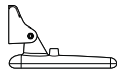
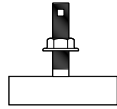
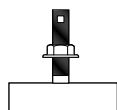
Part number	Description		Mounting Type	Construction
A80270	CPT-100 Down-Vision transducer		Transom	Plastic
A80277	CPT-110 Down-Vision transducer		Through-hull	Plastic
A80271	CPT-120 Down-Vision transducer		Through-hull	Bronze

CP200 compatible transducers

This product is compatible with the following Raymarine transducers.

Part number	Description		Mounting Type	Construction
A80281	CPT-200 Side-Vision transducer		Transom	Marine-grade stainless steel / plastic

3.6 Tools required

Product installation requires the following tools:

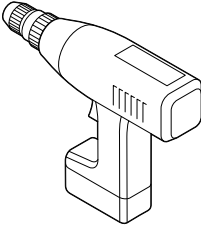
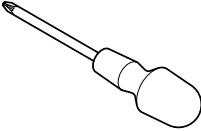
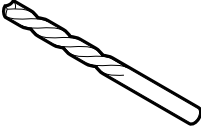
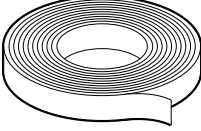
Item	Description	Quantity
	Power drill	1
	Pozidrive screwdriver	1
	Drill bit of appropriate size*	1
	Adhesive tape	1

Note: * The appropriate drill bit size is dependent on the thickness and material of the mounting surface.

3.7 Typical systems

Note: The following illustrations show the various products that can be connected in a typical system.

- Systems that include a CP200 sonar module can use a **SideVision** transducer in place of the illustrated **DownVision** transducer.
- For information on how to connect the products, refer to the [Chapter 4 Cables and connections](#) section.
- For information on available cables and accessories, refer to the [Chapter 10 Spares and accessories](#) section.

Example: basic sonar system featuring multifunction display

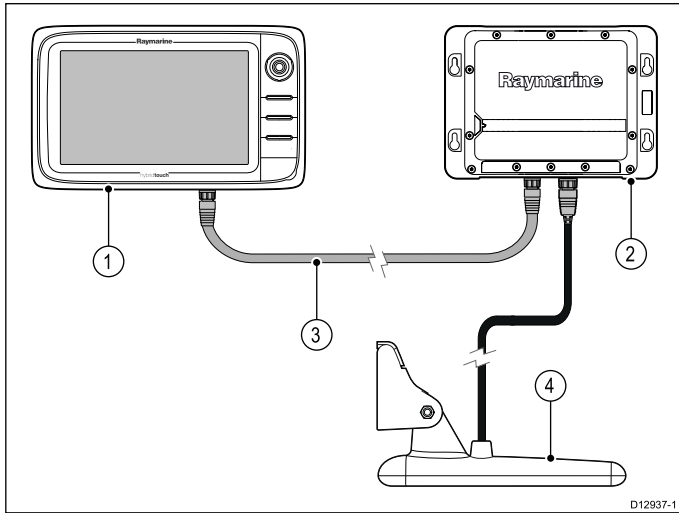

Item	Description
1	Multifunction display
2	Sonar module
3	RayNet cable
4	DownVision transducer

Example: expanded sonar system featuring autopilot system and multifunction display

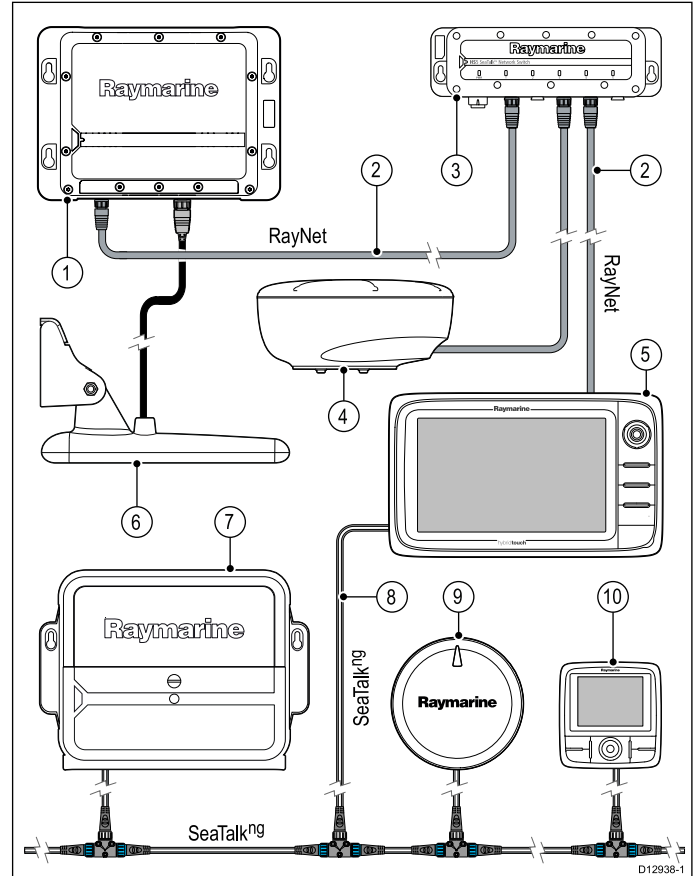

Item	Description
1	Sonar module
2	RayNet cables
3	RayNet network switch
4	Radar scanner
5	Multifunction display
6	DownVision transducer
7	Evolution ACU
8	SeaTalk ^{ng} spur cable
9	Evolution EV
10	Pilot head controller

3.8 Warnings and cautions

Important: Before proceeding, ensure that you have read and understood the warnings and cautions provided in the [Chapter 1 Important information](#) section of this document.

3.9 General location requirements

Important considerations when choosing a suitable location for your product.

This product is suitable for mounting above or below decks.

The product should be mounted where it will be:

- protected from physical damage and excessive vibration.
- well ventilated and away from heat sources.
- away from any potential ignition source such as an engine room, near fuel tanks or a gas locker.

When choosing a location for the product, consider the following points to ensure reliable and trouble-free operation:

- **Access** — there must be sufficient space to enable cable connections to the product, avoiding tight bends in the cable.
- **Diagnostics** — the product must be mounted in a location where the diagnostics LED is easily visible.

Note: Not all products include a diagnostics LED. Refer to the [Chapter 6 System checks and troubleshooting](#) for more information.

- **Electrical interference** — the product should be mounted far enough away from any equipment that may cause interference such as motors, generators and radio transmitters / receivers.
- **Magnetic compass** — refer to the *Compass safe distance* section in this document for advice on maintaining a suitable distance between this product and any compasses on your vessel.
- **Power** — to keep cable runs to a minimum, the product must be located as close as possible to the vessel's dc power supply.
- **Mounting surface** — ensure the product is adequately supported on a secure surface. Refer to the weight information provided in the *Technical specification* for this product and ensure that the intended mounting surface is suitable for bearing the product weight. Do NOT mount units or cut holes in places which may damage the structure of the vessel.

Compass safe distance

To prevent potential interference with the vessel's magnetic compasses, ensure an adequate distance is maintained from the product.

When choosing a suitable location for the product you should aim to maintain the maximum possible distance from any compasses. Typically this distance should be at least 1 m (3 ft) in all directions. However for some smaller vessels it may not be possible to locate the product this far away from a compass. In this situation, when choosing the installation location for your product, ensure that the compass is not affected by the product when it is in a powered state.

3.10 Product dimensions

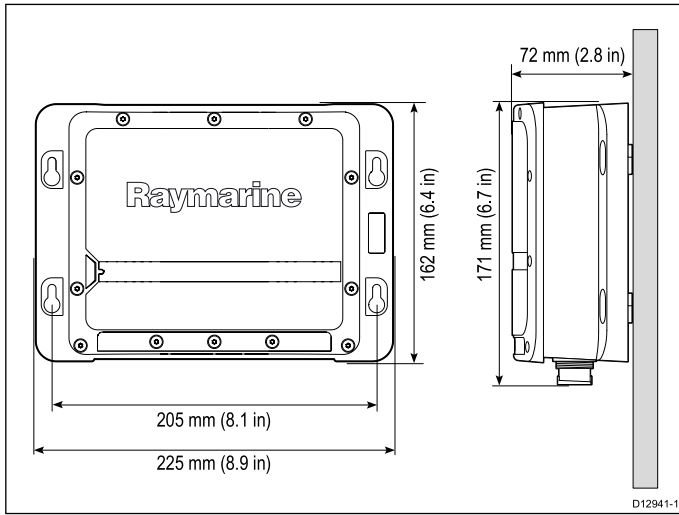

Chapter 4: Cables and connections

Chapter contents

- [4.1 General cabling guidance on page 28](#)
- [4.2 Connections overview on page 29](#)
- [4.3 Power connection on page 29](#)
- [4.4 Transducer connections on page 31](#)
- [4.5 Network connection on page 32](#)

4.1 General cabling guidance

Cable types and length

It is important to use cables of the appropriate type and length

- Unless otherwise stated use only standard cables of the correct type, supplied by Raymarine.
- Ensure that any non-Raymarine cables are of the correct quality and gauge. For example, longer power cable runs may require larger wire gauges to minimize voltage drop along the run.

Routing cables

Cables must be routed correctly, to maximize performance and prolong cable life.

- Do NOT bend cables excessively. Wherever possible, ensure a minimum bend diameter of 200 mm (8 in) / minimum bend radius of 100 mm (4 in).

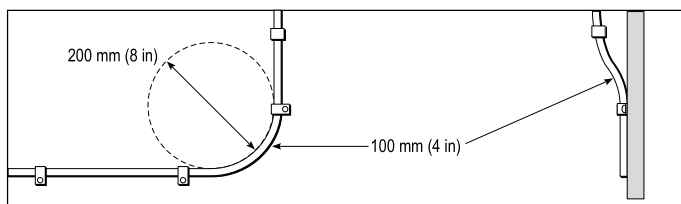

- Protect all cables from physical damage and exposure to heat. Use trunking or conduit where possible. Do NOT run cables through bilges or doorways, or close to moving or hot objects.
- Secure cables in place using tie-wraps or lacing twine. Coil any extra cable and tie it out of the way.
- Where a cable passes through an exposed bulkhead or deckhead, use a suitable watertight feed-through.
- Do NOT run cables near to engines or fluorescent lights.

Always route data cables as far away as possible from:

- other equipment and cables,
- high current carrying ac and dc power lines,
- antennae.

Caution: Pulling cables

Do NOT use cords or ropes, attached to cable connectors, to pull cables through restricted apertures (e.g. as in bulkheads), as this could cause damage to cables.

Strain relief

Ensure adequate strain relief is provided. Protect connectors from strain and ensure they will not pull out under extreme sea conditions.

Circuit isolation

Appropriate circuit isolation is required for installations using both AC and DC current:

- Always use isolating transformers or a separate power-inverter to run PC's, processors, displays

and other sensitive electronic instruments or devices.

- Always use an isolating transformer with Weather FAX audio cables.
- Always use an isolated power supply when using a 3rd party audio amplifier.
- Always use an RS232/NMEA converter with optical isolation on the signal lines.
- Always make sure that PC's or other sensitive electronic devices have a dedicated power circuit.

Cable shielding

Ensure that all data cables are properly shielded that the cable shielding is intact (e.g. hasn't been scraped off by being squeezed through a tight area).

Cable ferrite installation

Your product may be supplied with cable ferrites. To ensure EMC Compliance, any supplied ferrites must be fitted to the cables according to the following instructions.

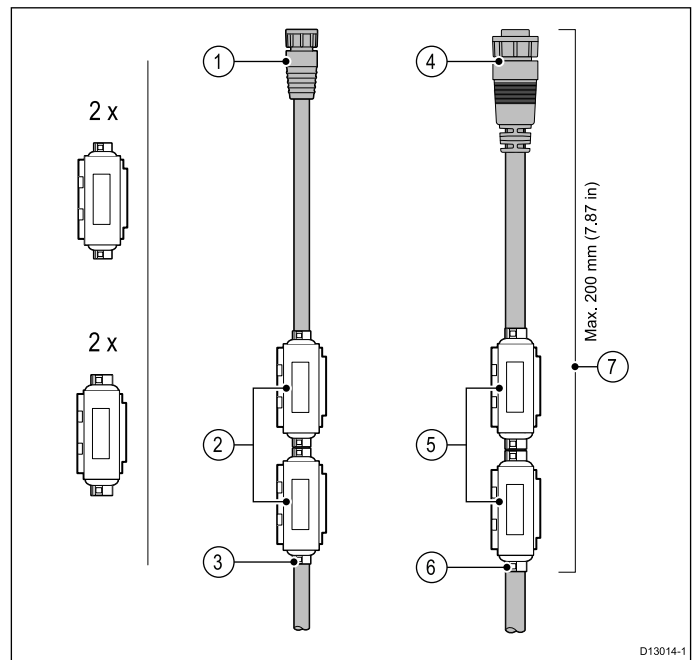

1. RayNet cable.
2. Fit 2 ferrites to the RayNet cable. There should be no gap between the 2 ferrites.
3. Secure the ferrites in place using the supplied cable ties.
4. Power cable.
5. Fit 2 ferrites to the power cable. There should be no gap between the 2 ferrites.
6. Secure the ferrites in place using the supplied cable ties.
7. Ensure the distance between the end of the last ferrite and the top of the connector is no more than 200 mm (7.87 in).

Note: If the ferrites are supplied in different sizes, ensure that you select the correct size for the appropriate cable. This is confirmed by a tight fit.

4.2 Connections overview

Use the following information to help you identify the connections on your product.

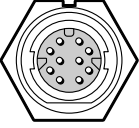
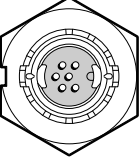
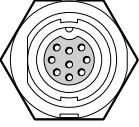
Connector	Connector panel label	Connects to:	Suitable cables
	Network	RayNet network or device.	Refer to the Chapter 10 Spares and accessories section.
	Power	12 V / 24 V power supply.	Supplied with your product.
	Transducer	Compatible transducer.	Supplied with the transducer.

Making connections

Follow the steps below to connect the cable(s) to your product.

1. Ensure that the vessel's power supply is switched off.
2. Ensure that the device being connected to the unit has been installed in accordance with the installation instructions supplied with that device.
3. Ensuring correct orientation, push the cable connector fully onto the corresponding connector on the unit.
4. Turn the locking collar clockwise to secure the cable.

4.3 Power connection

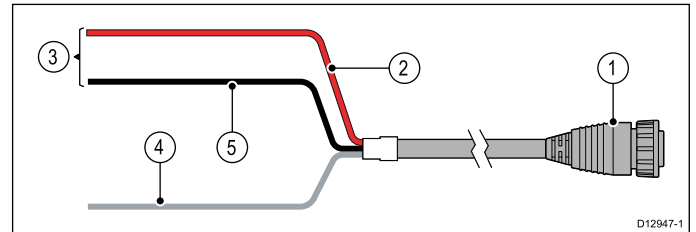

Note: For clarity, only the power-related cables are shown in the illustration above.

Item	Description	Connects to:
1	Power cable.	Product's power connector.
2	Red cable (positive)	Power supply's positive terminal.
3	Connection to 12 V / 24 V power supply.	Power supply.
4	Shield (drain) wire	Must be connected to RF ground point.
5	Black cable (negative)	Power supply's negative terminal.

Power cable extension

The product is supplied with a power cable, which can be extended if required.

- The power cable for each unit in your system should be run as a separate, single length of 2-wire cable from the unit to the vessel's battery or distribution panel.
- Raymarine recommends a **minimum** wire gauge of 18AWG (0.82 mm²) for any length of cable extension.
- Regardless of the length of the cable extension, any cable used should be capable of achieving a **minimum** voltage at the unit of 10.8 V with a fully flat battery at 11 V.

Power distribution

Raymarine recommends that all power connections are made via a distribution panel.

- All equipment must be powered from a breaker or switch, with appropriate circuit protection.
- Refer to the *Breakers, fuses and circuit protection* section for specific fuse and thermal breaker ratings for this product.

Breakers, fuses and circuit protection

The information below is provided as guidance to help protect your product. The example illustrations provided are for common vessel power arrangements, if you are unsure how to provide the correct level of protection then please consult a Raymarine authorized dealer for support.

Distribution panel connection

It is recommended that your product is wired through your vessel's distribution panel via a thermal breaker or fuse.

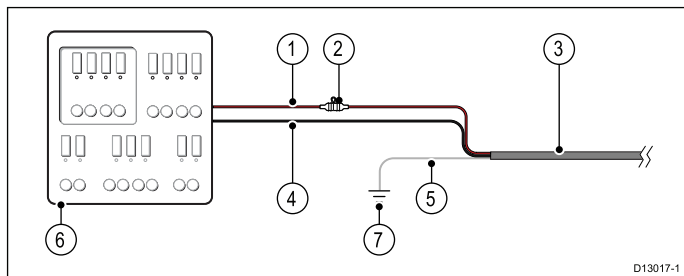

1. Vessel power supply positive (+)
2. In-line fuse (your product may contain a fuse already built in to the power cable.)
3. Product power cable
4. Vessel power supply negative (-)
5. * Drain wire
6. Vessel distribution panel
7. * Vessel RF ground point connection

Note: * Only applicable to products that include a drain wire on the product's power cable.

Thermal breaker rating

5 A (if only connecting one device)

Battery connection with RF ground

If your vessel does not have a distribution panel then your product may be wired directly to the battery with the drain wire connected to the vessel's RF ground point.

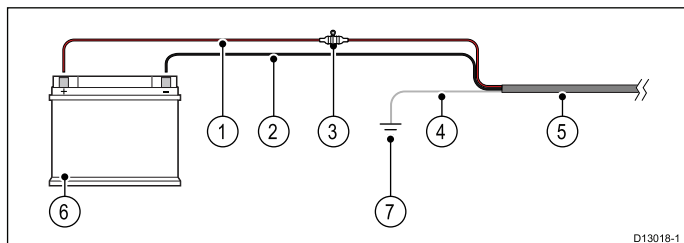

1. Vessel power supply positive (+)
2. Vessel power supply negative (-)
3. In-line fuse (If your products power cable does not have a built in fuse then an in-line fuse should be fitted.)
4. * Drain wire
5. Product power cable
6. Vessel battery
7. * Vessel RF ground point connection

Note: * Only applicable to products that include a drain wire on the product's power cable.

Battery connection with no RF ground

If your vessel does not have a distribution panel or an RF ground point then your product may be wired directly to the battery with the drain wire also connected to the battery's negative terminal.

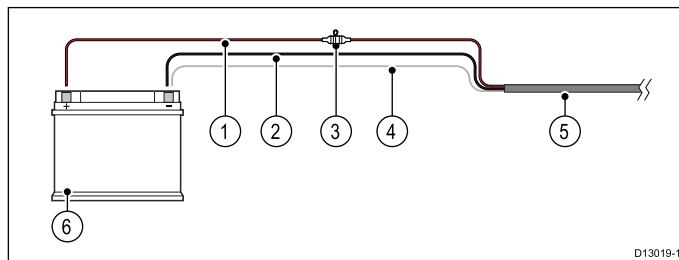

1. Vessel power supply positive (+)
2. Vessel power supply negative (-)
3. In-line fuse (If your products power cable does not have a built in fuse then an in-line fuse should be fitted.)
4. * Drain wire connected to vessel negative power supply.
5. Product power cable
6. Vessel battery

Note: * Only applicable to products that include a drain wire on the product's power cable.

Sharing a breaker

Where more than 1 piece of equipment shares a breaker you must provide protection for the individual circuits. E.g. by connecting an in-line fuse for each power circuit.

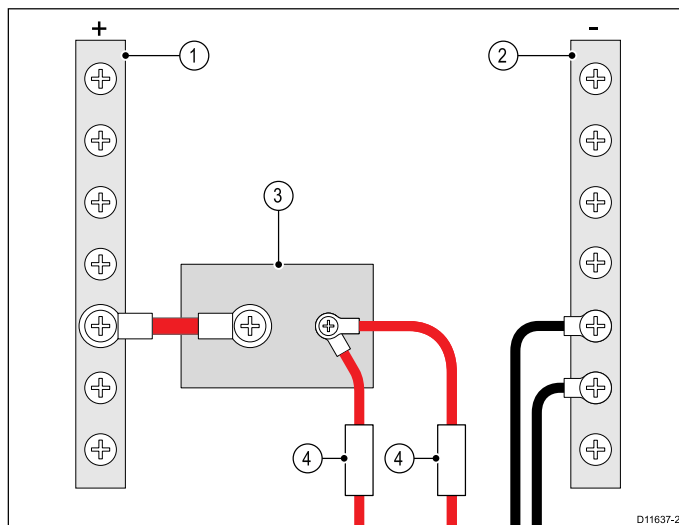

1	Positive (+) bar
2	Negative (-) bar
3	Circuit breaker
4	Fuse

Where possible, connect individual items of equipment to individual circuit breakers. Where this is not possible, use individual in-line fuses to provide the necessary protection.



Warning: Product grounding

Before applying power to this product, ensure it has been correctly grounded, in accordance with the instructions in this guide.

Grounding — Dedicated drain wire

The power cable supplied with this product includes a dedicated shield (drain) wire for connection to a vessel's RF ground point.

It is important that an effective RF ground is connected to the system. A single ground point should be used for all equipment. The unit can be grounded by connecting the shield (drain) wire of the power cable to the vessel's RF ground point. On vessels without an RF ground system the shield (drain) wire should be connected directly to the negative battery terminal.

The dc power system should be either:

- Negative grounded, with the negative battery terminal connected to the vessel's ground.
- Floating, with neither battery terminal connected to the vessel's ground



Warning: Positive ground systems

Do not connect this unit to a system which has positive grounding.

4.4 Transducer connections

Transducer connection — DownVision

The CP100 sonar module is designed for use with **DownVision** transducers.

- Refer to [CP100 compatible transducers](#) for a list of compatible transducers.
- Transducers must be installed in accordance with the instructions provided with the transducer.

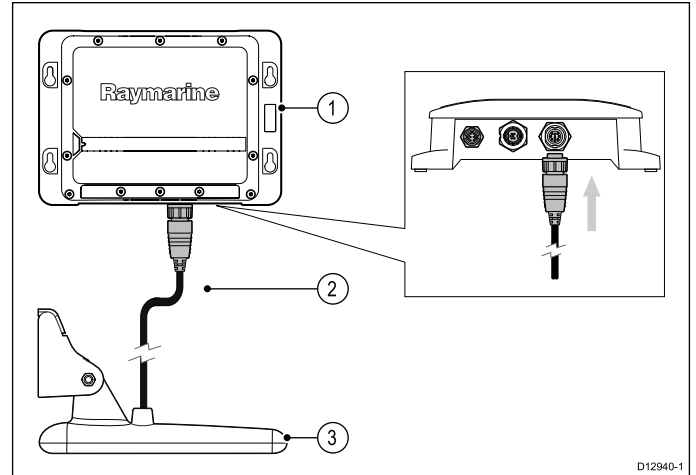

1. CP100 sonar module.
2. Transducer cable (supplied with transducer).
3. **DownVision** transducer.

Transducer connection — SideVision

The CP200 sonar module is designed for use with **SideVision** transducers.

- Refer to [CP200 compatible transducers](#) for a list of compatible transducers.
- Transducers must be installed in accordance with the instructions provided with the transducer.

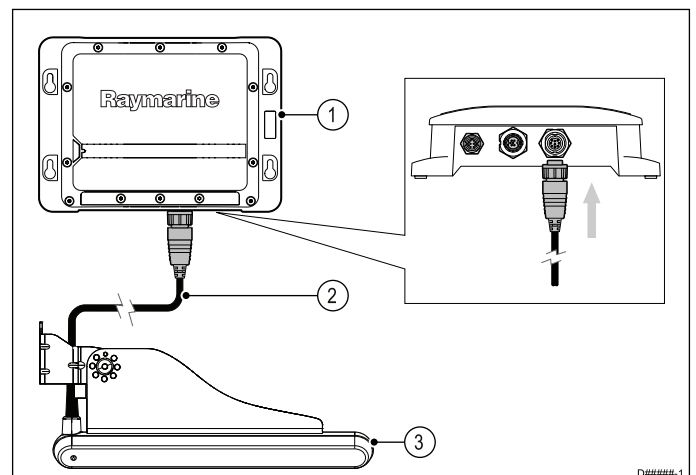

1. CP200 sonar module.
2. Transducer cable (supplied with transducer).
3. **SideVision** transducer.



Warning: Transducer cables

Do not remove the transducer cable whilst the product is powered on, doing so can cause sparks. If the transducer cable is accidentally removed whilst the product is powered on, switch the product's power off, replace the cable and then switch the power back on.

Caution: Do not cut transducer cables

- Cutting the transducer cable severely reduces sonar performance. If the cable is cut, it must be replaced, it cannot be repaired.
- Cutting the transducer cable will void the warranty and invalidate the European CE mark.

4.5 Network connection

The unit must be connected to a compatible Raymarine multifunction display to enable echo sounder data to be viewed.

Multifunction display connection

Unit connected to a multifunction display using a RayNet cable.

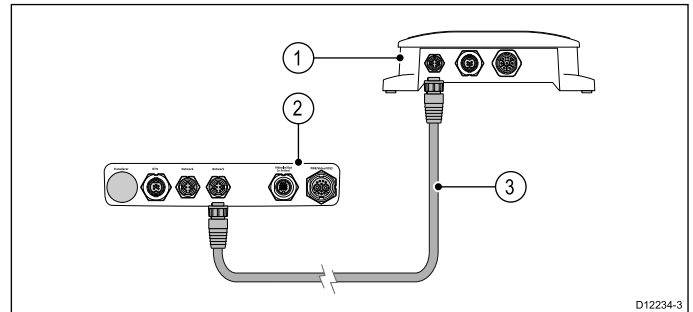

D12234-3

Note: The connection panel on your product may look slightly different to that shown, depending on variant. The network connection method remains the same for all products featuring RayNet connectors.

Item	Description
1	Sonar module.
2	Connector panel for compatible Raymarine multifunction display.
3	RayNet cable.

Transducer cable extension

For some installations it may be necessary to extend the transducer cable.

- Refer to [Chapter 10 Spares and accessories](#) for a list of suitable transducer extension cables.
- Raymarine recommends a maximum of one cable extension for any single transducer cable.
- For best performance, keep all cable lengths to a minimum.

Multifunction display configuration (extended cables)

When the required length of a single network cable run is greater than 20 m (65.6 ft), a RayNet (male) to (male) adaptor cable should be used to connect RayNet cables together .

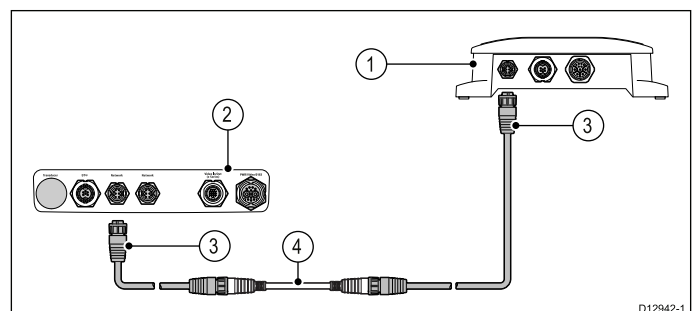

D12942-1

Note: The connection panel on your product may look slightly different to that shown, depending on variant. The network connection method remains the same for all products featuring RayNet connectors.

Item	Description
1	Sonar module.
2	Connector panel for compatible Raymarine multifunction display.
3	RayNet cables.
4	RayNet (Male) to (Male) adaptor cable.

Multiple multifunction display configuration

A Raymarine network switch can be used to connect the unit to more than 1 multifunction display.

Note: Ensure network cables and connections are tight and secure using any cable ties provided with your network hardware.

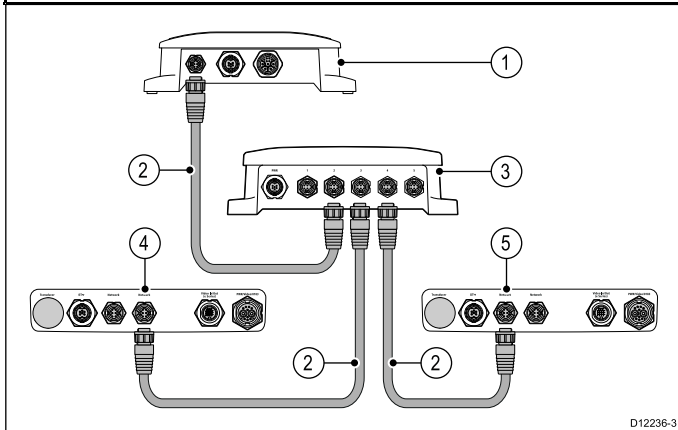

D12236-3

Note: The connection panel on your product may look slightly different to that shown, depending on variant. The network connection method remains the same for all products featuring RayNet connectors.

Item	Description
1	Sonar module.
2	RayNet cable.
3	RayNet network switch.
4	Connector panel for compatible Raymarine multifunction display.
5	Connector panel for additional compatible Raymarine multifunction display.

For details on available network hardware and cables refer to [Chapter 10 Spares and accessories](#).

Chapter 5: Mounting

Chapter contents

- [5.1 Mounting on page 36](#)

5.1 Mounting

Mounting the unit

Having chosen a suitable location, install the unit as follows:

Note: Raymarine recommends mounting the unit vertically.

1. Secure the mounting template in the required location using adhesive tape.

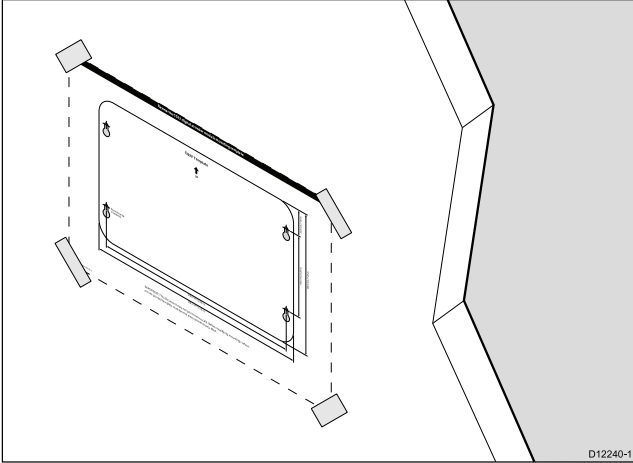

2. Drill 4 holes at the marked location on the template.

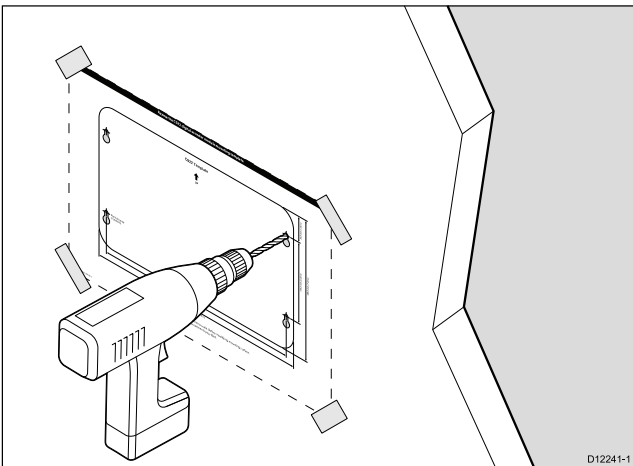

3. Remove the mounting template.
4. Screw in the supplied fixing screws about half way into the holes.
5. Place the unit onto the fixing screws.
6. Push the unit down to engage the key slots in the unit.
7. Tighten the screws

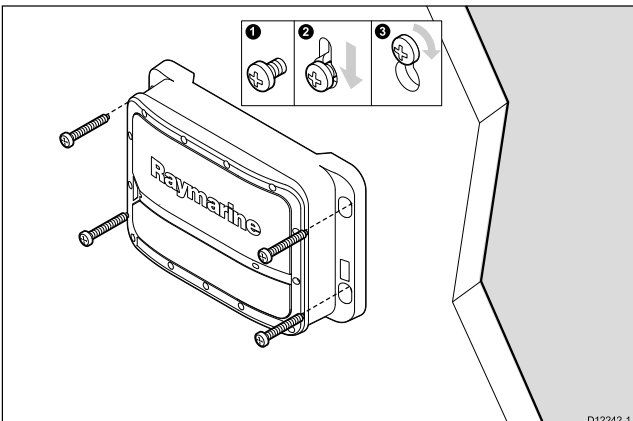

Note: Drill bit, tap size and tightening torque is dependent on the thickness and type of material the unit is to be mounted on.

Chapter 6: System checks and troubleshooting

Chapter contents

- [6.1 Initial power on test on page 38](#)
- [6.2 Troubleshooting on page 38](#)
- [6.3 Sonar troubleshooting on page 39](#)
- [6.4 Sonar crosstalk interference on page 40](#)
- [6.5 LED indications on page 42](#)
- [6.6 Resetting the sonar module on page 43](#)

6.1 Initial power on test

Once the unit has been correctly installed check that it is operating correctly.

After powering on, the unit will take approximately 50 seconds to start up. From powering on through to normal operation, the LED status indicator should be green. If the LED status indicator is not green then refer to the troubleshooting section of this handbook.

Open the Fishfinder application on your connected multifunction display and ensure that it is operating correctly.

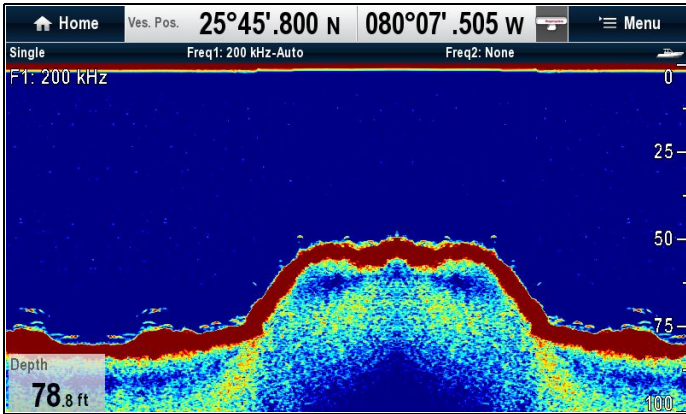

Switching the active sonar module

If you have multiple sonar modules on your network you can select which sonar module will be active in the Fishfinder application.

From the Fishfinder application:

1. Select **Menu**.
2. Select **Sounder**:
A list of available sonar modules is displayed.
3. Select the Sonar module from the list that you want to display in the Fishfinder application.

Operation instructions

For detailed operation instructions for your product, refer to the documentation that accompanies your display.

6.2 Troubleshooting

The troubleshooting information provides possible causes and corrective action required for common problems associated with marine electronics installations.

All Raymarine products are, prior to packing and shipping, subjected to comprehensive test and quality assurance programs. However, if you experience problems with the operation of your product this section will help you to diagnose and correct problems in order to restore normal operation.

If after referring to this section you are still having problems with your unit, please contact Raymarine Technical Support for further advice.

6.3 Sonar troubleshooting

Problems with the sonar and their possible causes and solutions are described here.

Problem	Possible causes	Possible solutions
Sonar data not available on multifunction display.	Unit power supply fault.	Check the unit power supply and cables.
	Other unit fault.	Refer to the instructions supplied with the unit.
	SeaTalk ^{hs} / RayNet network problem.	Check that the unit is correctly connected to a Raymarine network switch. If a crossover coupler or other coupler cable / adapter is used, check all connections (as applicable).
		Check the status of the Raymarine network switch (if applicable).
		Check that SeaTalk ^{hs} / RayNet cables are free from damage.
Software mismatch between equipment may prevent communication.	Contact Raymarine technical support.	
Problematic data readings. Note: Not all transducers and / or sonar modules support the detection of depth, range and temperature. For more information, refer to the latest specifications and documentation available for your particular products on the Raymarine website (www.raymarine.com).	Gain or Frequency settings may be inappropriate for present conditions.	Check the sonar presets, gain and frequency settings.
	Unit power supply fault.	Check the voltage from the power supply, if this is too low it can affect the transmitting power of the unit.
	Unit cable fault.	Ensure that the power, transducer and all other cables to the unit are properly connected and free from damage.
	Transducer fault.	Check that the transducer is mounted correctly and is clean.
		If you have a transom mount transducer, check that the transducer hasn't kicked-up due to hitting an object.
	Other unit fault.	Refer to the instructions supplied with the unit.
	Vessel stationary.	Fish arches are not displayed if the vessel is stationary; fish will appear on the display as straight lines.
	High vessel speed	Turbulence around the transducer may be confusing the unit.
	Scroll speed set to zero	Adjust the scroll speed.

6.4 Sonar crosstalk interference

There are 2 types of potential sonar crosstalk interference in a Raymarine sonar system:

1. **SideVision** sonar crosstalk interference
2. Multiple sonar crosstalk interference

The types of crosstalk interference that you may experience in your system depend on the combination and type of sonar equipment installed, and the way in which the equipment has been installed.

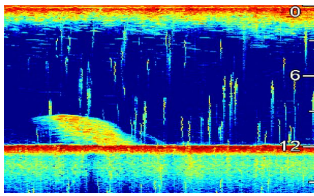
SideVision sonar crosstalk interference	Multiple sonar crosstalk interference
	
<p>Due to the high sensitivity of SideVision transducers, you may experience some minor crosstalk interference between the left and right receiving channels in areas of strong target returns. Examples of strong target returns include solid objects such as underwater bridge structure. This interference shows up in the Fishfinder application as subtle reflections from the right sonar image displayed in the left sonar image, or vice versa.</p>	<p>When using multiple sonar modules and transducers operating in overlapping frequency ranges, you may experience some crosstalk interference between the ranges. This interference is displayed in the Fishfinder application as vertical “rain drops” throughout the water column. These vertical “rain drops” indicate that 2 sonar modules are operating in close frequency proximity to one another.</p>

SideVision sonar crosstalk interference

Crosstalk interference is expected behavior in a high sensitivity device such as a **SideVision** transducer, and is not indicative of a fault with your transducer or sonar module.

Reducing multiple sonar crosstalk interference

Crosstalk interference in systems with multiple sonar modules and transducers is the result of a number of factors, including installation, operation, and environment.

- **Choose an equipment combination that minimizes overlapping frequencies.** Wherever possible, choose to use sonar modules and transducers that operate in different frequency ranges (“Channels”), for example CP100 and CP300 sonar modules and CPT-100 and B744V transducers. This will help to ensure that each component is operating in a distinct relative frequency range – for example, a “high” frequency range for the CP100 and a “low” frequency range for the CP300.
- **Only use the sonar channels that you really need.** Although it is possible to run multiple sonar

modules simultaneously in a Raymarine system, it may not always be necessary to do so. If you are in a scenario that requires only one sonar module to be active at a time, disable any other sonar modules by changing the Fishfinder application pane to a single one which only displays the output from one sonar module. Alternatively, disable the ping for any unused sonar modules by selecting **MENU > Channel > Ping > OFF** in the Fishfinder application.



















- **Identify the sonar module and transducer that is causing the interference.** To do this, disable the ping or remove the power for one of the sonar modules in your system. If the interference in the Fishfinder application disappears immediately, you now know which device is causing the interference. If the interference doesn’t disappear, repeat the exercise again with the other sonar module(s) in your system, one at a time. Once you know which device is causing the interference, proceed with the following methods to reduce the interference from the relevant device.
- **Adjust the Interference Rejection Filter.** The default setting for all Raymarine MFDs is “Auto”. Changing this setting to “High” might help to reduce interference (**MENU > Setup > Sounder Setup > Interference Rejection**). Note that the Interference Rejection Filter setting is not available for all sonar modules.
- **Decrease the power output of the interfering transducer.** Adjusting the “Power Mode” in the Sensitivity Settings in the MFD’s Fishfinder application can help to minimize the presence of crosstalk interference (**MENU > Sensitivity Settings > Power Mode**). Note that the Power Mode setting is not available for all transducers.
- **Ensure that you have a common RF ground point for all electrical equipment on your vessel.** On vessels without an RF ground system, ensure all product drain wires (where available) are connected directly to the negative battery terminal. Ineffective RF grounding can cause electrical interference which may in turn result in sonar crosstalk interference.
- **Increase the physical distance between your sonar modules.** Electrical interference may be occurring between a cable on one sonar module, and a cable on a different sonar module. Ensure that your sonar modules are physically located as far away from each other as possible.
- **Increase the physical distance between your sonar transducers.** Electrical and / or acoustic interference may be occurring between the different transducers in your system. Ensure that your transducers are physically located as far away from each other as possible.

Note: Given the effort and potential difficulties involved in relocating sonar equipment, it should only be considered as a last resort when you judge the interference to be a significant problem which cannot be resolved using the methods described above.

Note: Due to physical size and other constraints that vary from vessel to vessel, it may not be possible to completely eliminate crosstalk interference from your system. However, this will not impede your ability to benefit from the full capabilities of your sonar system. Being able to easily identify the way in which interference is displayed in the Fishfinder application can sometimes be the best and easiest route to dealing with it.

6.5 LED indications

The power LED for this product has a number of flashing (blinking) modes to provide status information for diagnostics and troubleshooting.

LED color	LED code	Status	User action	
		Solid Green	Power On	<ul style="list-style-type: none"> None (normal power up takes <1 minute.)
		Green 1 blink	Normal operation	<ul style="list-style-type: none"> None
		Amber 1 blink	Transducer disconnected	<ul style="list-style-type: none"> Ensure transducer cable and connections are secure and free from damage. Power cycle unit to recover transducer information. If problem persists contact Raymarine technical support.
		Amber 2 blinks	No network detected	<ul style="list-style-type: none"> Ensure network is powered. Ensure network cable and connections are secure and free from damage. If problem persists contact Raymarine technical support.
		Amber 5 blinks	Under voltage (<10.2V)	<ul style="list-style-type: none"> Ensure power cable and connections are secure and free from damage. Ensure power supply cabling is consistent with recommendations. If problem persists contact Raymarine technical support.
		Amber 6 blinks	Over voltage (>34.2V)	<ul style="list-style-type: none"> Ensure power supply levels are consistent with recommendations. If problem persists contact Raymarine technical support.
		Red 1 blink	General failure	<ul style="list-style-type: none"> If combined with voltage warning, check power supply and cables. Power-cycle the unit. If problem persists contact Raymarine technical support.
		Red 3 blinks	Unit overheating	<ul style="list-style-type: none"> Ensure installation environment is within recommendations. Unit will stop pinging and then start again once normal operating temperature is achieved. If problem persists contact Raymarine technical support.
		Red 4 blinks	Problems with internal database	<ul style="list-style-type: none"> Power-cycle the unit. If problem persists contact Raymarine technical support.

Note: If any other LED sequence other than described above is seen and persists please contact Raymarine technical support.

6.6 Resetting the sonar module

You can use the reset function on a compatible Raymarine multifunction display to restore the sonar module to its factory default settings.

In the fishfinder application:

1. Select **Menu**.
2. Select **Set-up**.
3. Select **Sounder Set-up**.
4. Select **Sonar Reset**.
5. Select **Yes** to confirm or **No** to abort the operation, as appropriate.

The unit will now be reset to factory default settings.

Chapter 7: Maintenance

Chapter contents

- [7.1 Routine checks on page 46](#)
- [7.2 Unit cleaning instructions on page 46](#)
- [7.3 Transducer care and cleaning on page 47](#)

7.1 Routine checks

The following periodic checks should be made:

- Examine cables for signs of damage, such as chafing, cuts or nicks.
- Check that the cable connectors are firmly attached and that their locking mechanisms are properly engaged.

Note: Cable checks should be carried out with the power supply switched off.



Warning: High voltage

This product contains high voltage. Adjustments require specialized service procedures and tools only available to qualified service technicians. There are no user serviceable parts or adjustments. The operator should never remove the cover or attempt to service the product.

7.2 Unit cleaning instructions

The unit does not require regular cleaning. However, if you find it necessary to clean the unit, please follow the steps below:

1. Ensure power is switched off.
2. Wipe unit clean with a damp cloth.
3. If necessary, use a mild detergent solution to remove grease marks.

7.3 Transducer care and cleaning

Growth can collect on the bottom of the transducer, this can reduce performance. To prevent the build-up of sea growth, coat the transducer with a thin layer of water-based antifouling paint, available from your local marine dealer. Reapply paint every 6 months or at the beginning of each boating season. Certain smart transducers have restrictions on where antifouling paint is applied. Please consult your dealer.

Note: Transducers with a temperature sensor may not work properly if painted.

Note: Never use ketone-based paint. Ketones can attack many plastics, possibly damaging the sensor.

Note: Never use spray paint on your transducer. Spraying incorporates tiny air bubbles, and a marine transducer cannot transmit properly through air.

Use a soft cloth and mild household detergent to clean the transducer. If the fouling is severe, remove the growth with a tough cleaning pad, such as a green Scotch Brite™ pad for example. Be careful to avoid scratching the face of the transducer.

Note: Harsh cleaning solvents such as acetone WILL damage the transducer.

Chapter 8: Technical support

Chapter contents

- [8.1 Raymarine customer support on page 50](#)
- [8.2 Viewing product information on page 50](#)

8.1 Raymarine customer support

Raymarine provides a comprehensive customer support service. You can contact customer support through the Raymarine website, telephone and e-mail. If you are unable to resolve a problem, please use any of these facilities to obtain additional help.

Web support

Please visit the customer support area of our website at:

www.raymarine.com

This contains Frequently Asked Questions, servicing information, e-mail access to the Raymarine Technical Support Department and details of worldwide Raymarine agents.

Telephone and e-mail support

In the USA:

- **Tel:** +1 603 324 7900
- **Toll Free:** +1 800 539 5539
- **E-mail:** support@raymarine.com

In the UK, Europe, and the Middle East:

- **Tel:** +44 (0)13 2924 6777
- **E-mail:** ukproduct.support@raymarine.com

In Southeast Asia and Australia:

- **Tel:** +61 (0)29479 4800
- **E-mail:** aus.support@raymarine.com

Product information

If you need to request service, please have the following information to hand:

- Product name.
- Product identity.
- Serial number.
- Software application version.
- System diagrams.

You can obtain this product information using the menus within your product.

8.2 Viewing product information

You can view information about your unit from the **Diagnostics** menu on a compatible multifunction display. This option displays information such as product serial number and software version.

With the Homescreen displayed:

1. Select **Set-up**.
2. Select **Maintenance**.
3. Select **Diagnostics**.
4. Select the **Select Device** option.
A list of connected devices is displayed.
5. Select the product for which you want to view information. Alternatively, select **Show All Data** to display information for all connected products.

Chapter 9: Technical specification

Chapter contents

- [9.1 Technical specification on page 52](#)

9.1 Technical specification

Physical specification

Dimensions	<ul style="list-style-type: none"> • Width: 225 mm (8.9 in). • Height: 162 mm (6.4 in). • Height (including connectors): 171 mm (6.7 in). • Depth: 72 mm (2.8 in).
Weight	0.6 kg (1.32 lbs)

Power specification

Nominal supply voltage	12 V / 24 V dc
Operating voltage range	10.8 V to 31.2 V dc
Power consumption	5.6 W (maximum)
Current	1 A peak
Fuse / breakers	5 A

Sonar / DownVision specification

Channels	2 x CHIRP (1 x sonar and 1 x DownVision)
Beam coverage	<ul style="list-style-type: none"> • Sonar — conical beam. • DownVision — Wide (port / starboard) and thin (fore / aft) fan beam.
Depth	Typical depth performance of 183 m (600 ft). Applies to both Sonar and DownVision channels.

SideVision specification

Channels	2 x CHIRP
Beam coverage	Port- and starboard-facing fan beams — wide (port / starboard) and thin (fore / aft) .
Range	Up to 183 m (600 ft). Note: Range performance is dependent on many factors, including water quality, transducer installation, and reflectivity of targets and structure.

Environmental specification

Operating temperature	0°C to +55°C (+32°F to +131°F)
Storage temperature	-30°C to +70°C (-22°F to +158°F)
Relative humidity	95%
Waterproof rating	IPX6 and IPX7

Conformance specification

Conformance	<ul style="list-style-type: none"> • EN 60945:2002 • EMC Directive 2004/108/EC • Australia and New Zealand: C-Tick, Compliance Level 2
-------------	---

Chapter 10: Spares and accessories

Chapter contents

- 10.1 Spares and accessories on page 54
- 10.2 Network hardware on page 54
- 10.3 Network cable connector types on page 55
- 10.4 **RayNet** to **RayNet** cables and connectors on page 56
- 10.5 RayNet to RJ45 adapter cables on page 57
- 10.6 SeaTalk^{ng} cables and accessories on page 58

10.1 Spares and accessories

CP100 spares and accessories

The following accessories and spare parts are available for the CP100:

Spares

Item	Part number
1 m (3.28 ft) power cable	A06049

Accessories

Item	Part number
4 m (13.12 ft) transducer extension cable for CPT-100 transom transducer	A80273
CPT-100 Transom DownVision transducer	A80270
CPT-110 Through-hull DownVision transducer (plastic)	A80277
CPT-120 Through-hull DownVision transducer (bronze)	A80271
Transom transducer shield for vessels with a trolling motor	A80207

CP200 spares and accessories

The following accessories and spare parts are available for the CP200:

Spares

Item	Part number
1 m (3.28 ft) power cable	A06049

Accessories

Item	Part number
4 m (13.12 ft) transducer extension cable for CPT-200 transom SideVision transducer	A80305
CPT-200 Transom SideVision transducer	A80281

10.2 Network hardware

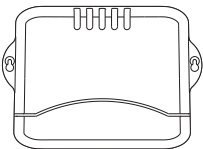
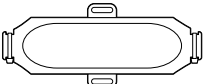
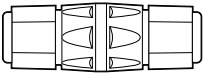
Item	Part number	Notes
HS5 RayNet network switch 	A80007	5-port switch for network connection of multiple devices featuring RayNet connectors. Equipment with RJ45 SeaTalk ^{hs} connectors can also be connected using suitable adapter cables.
RJ45 SeaTalk ^{hs} network switch 	E55058	8-port switch for network connection of multiple SeaTalk ^{hs} devices featuring RJ45 connectors.
RJ45 SeaTalk ^{hs} crossover coupler 	E55060	<ul style="list-style-type: none"> Enables direct connection of RJ45 SeaTalk^{hs} devices to smaller systems where a switch is not required. Enables the connection of RJ45 SeaTalk^{hs} devices to a HS5 RayNet network switch (in conjunction with suitable adapter cables). Enables 2 RJ45 SeaTalk^{hs} cables to be connected together to extend the length of the cabling. <p>Recommended for internal installations.</p> <div style="border: 1px solid black; padding: 5px;"> <p>Important: Do NOT use crossover devices for POE (Power Over Ethernet) connections.</p> </div>
Ethernet RJ45 coupler 	R32142	<ul style="list-style-type: none"> Enables direct connection of RJ45 SeaTalk^{hs} devices to smaller systems where a switch is not required. Enables the connection of RJ45 SeaTalk^{hs} devices to a HS5 RayNet network switch (in conjunction with suitable adapter cables). Enables 2 RJ45 SeaTalk^{hs} cables to be connected together to extend the length of the cabling. <p>Recommended for external installations.</p>

10.3 Network cable connector types

There are 2 types of network cable connector — RayNet, and RJ45 SeaTalk^{hs}.

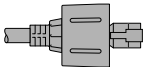
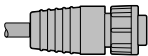
	RJ45 SeaTalk^{hs} connector.
	RayNet connector.

10.4 RayNet to RayNet cables and connectors

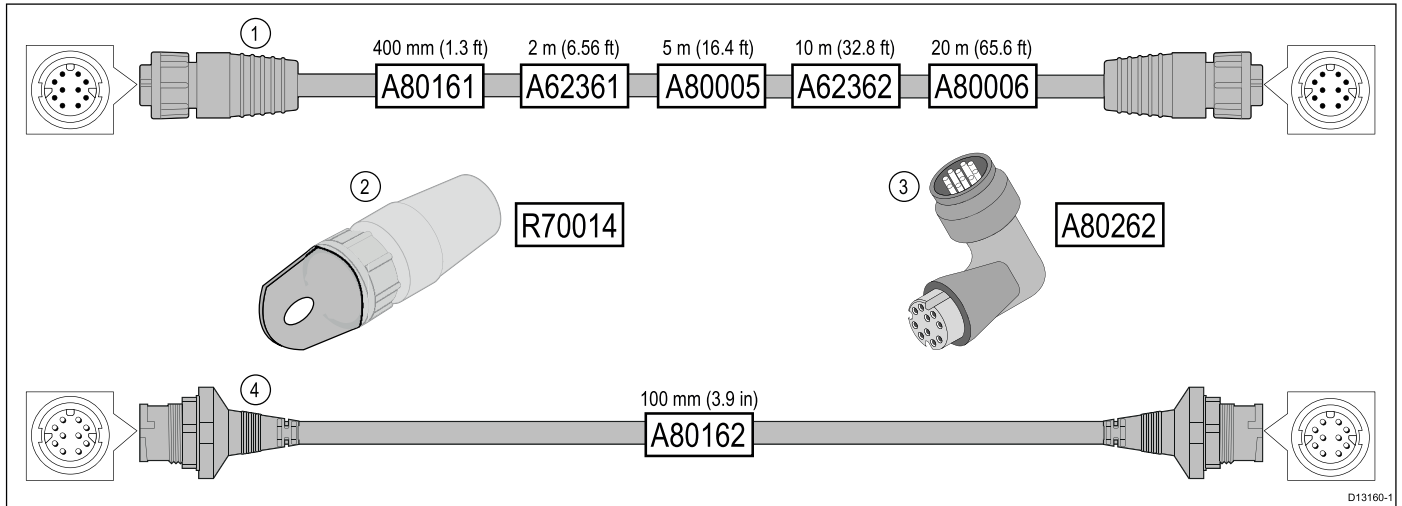

D13160-1

	Description	Typical use	Quantity
1	Standard RayNet connection cable with a RayNet (female) socket on both ends.	Suitable for connecting all RayNet equipment directly to LightHouse multifunction displays featuring a RayNet connector. Can also be used to connect RayNet equipment via a RayNet network switch (e.g. HS5).	1
2	RayNet cable puller (5 pack).	These “handles” securely attach to the twist-lock on RayNet cables, enabling you to pull the cables through conduits and other obstacles.	5
3	RayNet to RayNet right-angle coupler / adapter.	Suitable for connecting RayNet cables at 90° (right angle) to devices, for installations where space is limited. For example, use this adapter to connect a RayNet cable to a multifunction display when there is not enough space behind the display for the usual cable bend radius required by a standard RayNet cable. This adapter features a RayNet (female) socket at one end, and a RayNet (male) plug at the other end.	1
4	Adapter cable with a RayNet (male) plug on both ends.	Suitable for joining (female) RayNet cables together for longer cable runs.	1

10.5 RayNet to RJ45 adapter cables

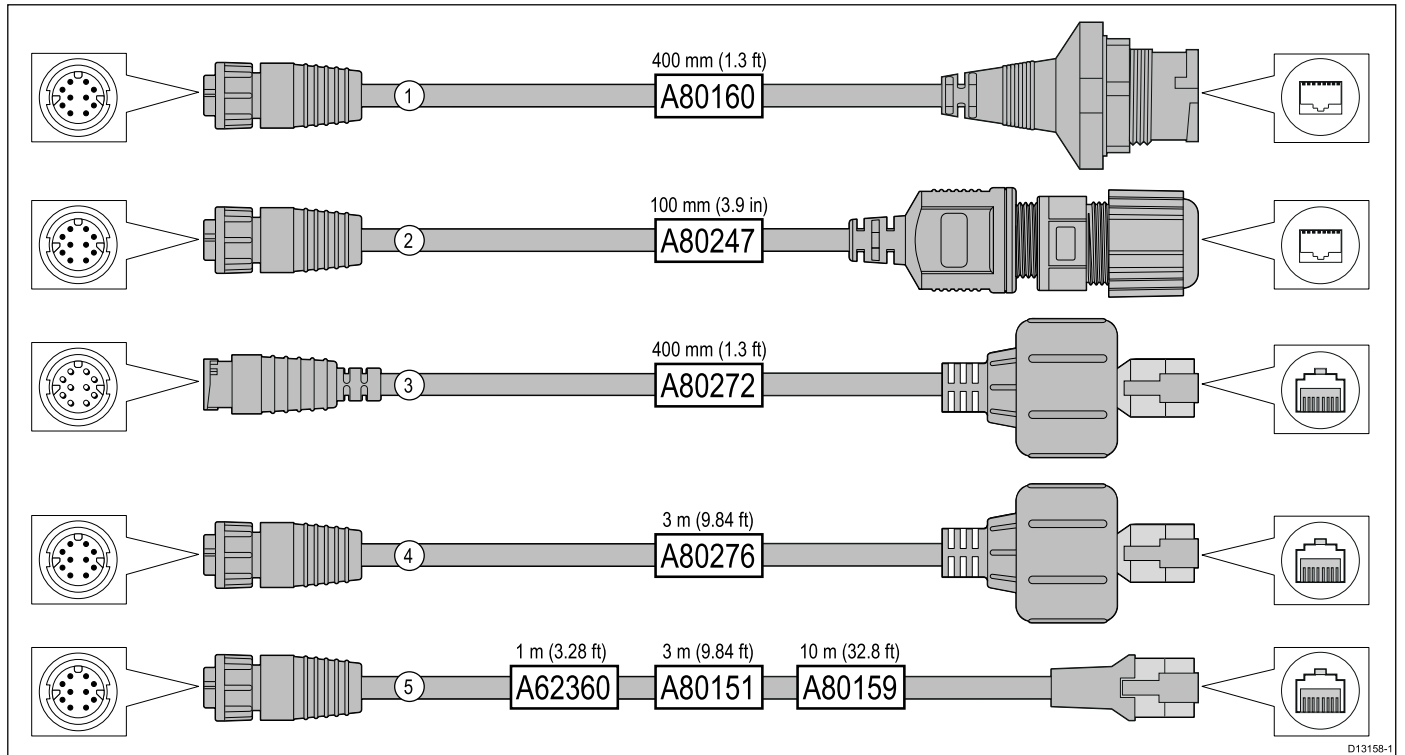

D13158-1

	Description	Typical use	Quantity
1	<p>Adapter cable with a RayNet (female) socket on one end, and a waterproof (female) socket on the other end accepting the following cables with an RJ45 SeaTalk^{hs} waterproof locking (male) plug:</p> <ul style="list-style-type: none"> • A62245 (1.5 m). • A62246 (15 m). 	<p>A typical use for this adapter cable is to connect a DSM300 sonar module to a LightHouse MFD, using all-waterproof cable connections. This adapter cable will also accept the following RJ45 SeaTalk^{hs} cables, although the RJ45 plug that connects at the equipment end (e.g. DSM300) will NOT be waterproof:</p> <ul style="list-style-type: none"> • E55049 (1.5 m). • E55050 (5 m). • E55051 (10 m). • A62135 (15 m). • E55052 (20 m). 	1
2	<p>Adapter cable with a RayNet (female) socket on one end, and a waterproof (female) RJ45 socket on the other end, along with a locking gland for a watertight fit.</p>	<p>Directly connect a Raymarine radar scanner with an RJ45 SeaTalk^{hs} (male) cable to a RayNet network switch (e.g. HS5) or LightHouse MFD.</p>	1
3	<p>Adapter cable with a RayNet (male) plug on one end, and an RJ45 SeaTalk^{hs} waterproof (male) plug on the other end.</p>	<p>Connect a legacy G-Series GPM-400, C-Series Widescreen or E-Series Widescreen MFD to a Raymarine radar scanner supplied with a RayNet power / data cable.</p>	1
4	<p>Adapter cable with a RayNet (female) socket on one end, and an RJ45 SeaTalk^{hs} waterproof (male) plug on the other end.</p>	<p>Connect a legacy G-Series GPM-400, C-Series Widescreen or E-Series Widescreen MFD to a RayNet network switch (e.g. the HS5).</p>	1
5	<p>Adapter cable with a RayNet (female) socket on one end, and an RJ45 SeaTalk^{hs} (female) socket on the other end.</p>	<p>Connect a LightHouse MFD to a legacy SR6 switch / weather receiver or a legacy 8-port SeaTalk^{hs} network switch. Another common use for the cable is in conjunction with a crossover coupler (E55060 or R32142) to connect Raymarine products with an RJ45 connection (e.g. radar scanner, thermal camera or DSM300) to a LightHouse MFD or RayNet network switch (e.g. the HS5).</p>	1

10.6 SeaTalk^{ng} cables and accessories

SeaTalk^{ng} cables and accessories for use with compatible products.

Description	Part No	Notes
SeaTalk ^{ng} starter kit	T70134	Includes: <ul style="list-style-type: none"> • 1 x 5 Way connector (A06064) • 2 x Backbone terminator (A06031) • 1 x 3 m (9.8 ft) spur cable (A06040) • 1 x Power cable (A06049)
SeaTalk ^{ng} Backbone Kit	A25062	Includes: <ul style="list-style-type: none"> • 2 x 5 m (16.4 ft) Backbone cable (A06036) • 1 x 20 m (65.6 ft) Backbone cable (A06037) • 4 x T-piece (A06028) • 2 x Backbone terminator (A06031) • 1 x Power cable (A06049)
SeaTalk ^{ng} 0.4 m (1.3 ft) spur	A06038	
SeaTalk ^{ng} 1 m (3.3 ft) spur	A06039	
SeaTalk ^{ng} 3 m (9.8 ft) spur	A06040	
SeaTalk ^{ng} 5 m (16.4 ft) spur	A06041	
SeaTalk ^{ng} 0.4 m (1.3 ft) elbow spur	A06042	
SeaTalk ^{ng} 0.4 m (1.3 ft) backbone	A06033	
SeaTalk ^{ng} 1 m (3.3 ft) backbone	A06034	
SeaTalk ^{ng} 3 m (9.8 ft) backbone	A06035	
SeaTalk ^{ng} 5 m (16.4 ft) backbone	A06036	
SeaTalk ^{ng} 9 m (29.5 ft) backbone	A06068	
SeaTalk ^{ng} 20 m (65.6 ft) backbone	A06037	
SeaTalk ^{ng} to bare ends 1 m (3.3 ft) spur	A06043	
SeaTalk ^{ng} to bare ends 3 m (9.8 ft) spur	A06044	

Description	Part No	Notes
SeaTalk ^{ng} Power cable	A06049	
SeaTalk ^{ng} Terminator	A06031	
SeaTalk ^{ng} T-piece	A06028	Provides 1 x spur connection
SeaTalk ^{ng} 5-way connector	A06064	Provides 3 x spur connections
SeaTalk ^{ng} backbone extender	A06030	
SeaTalk to SeaTalk ^{ng} converter kit	E22158	Allows the connection of SeaTalk devices to a SeaTalk ^{ng} system.
SeaTalk ^{ng} Inline terminator	A80001	Provides direct connection of a spur cable to the end of a backbone cable. No T-piece required.
SeaTalk ^{ng} Blanking plug	A06032	
ACU / SPX SeaTalk ^{ng} spur cable 0.3 m (1.0 ft)	R12112	Connects an SPX course computer or an ACU to a SeaTalk ^{ng} backbone.
SeaTalk (3 pin) to SeaTalk ^{ng} adaptor cable 0.4 m (1.3 ft)	A06047	
SeaTalk to SeaTalk ^{ng} spur 1 m (3.3 ft) spur	A22164	
SeaTalk2 (5 pin) to SeaTalk ^{ng} adaptor cable 0.4 m (1.3 ft)	A06048	
DeviceNet adaptor cable (Female)	A06045	Allows the connection of NMEA 2000 devices to a SeaTalk ^{ng} system.
DeviceNet adaptor cable (Male)	A06046	Allows the connection of NMEA 2000 devices to a SeaTalk ^{ng} system.
DeviceNet adaptor cable (Female) to bare ends.	E05026	Allows the connection of NMEA 2000 devices to a SeaTalk ^{ng} system.
DeviceNet adaptor cable (Male) to bare ends.	E05027	Allows the connection of NMEA 2000 devices to a SeaTalk ^{ng} system.

Raymarine[®]
A FLIR COMPANY