

# i40

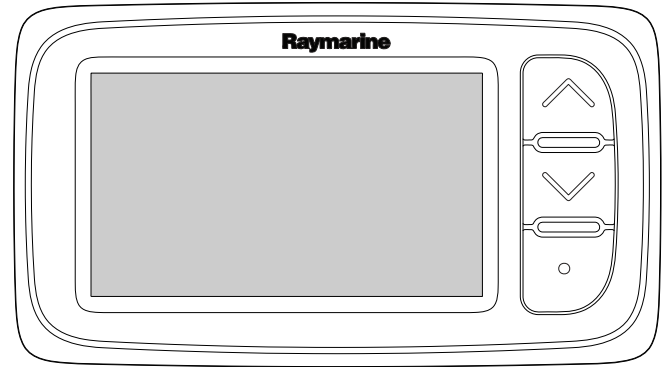

## Installation and operation instructions

**English**

Date: 06-2014

Document number: 81340-2-EN

© 2014 Raymarine UK Limited



## **Trademark and patents notice**

Autohelm, hsb<sup>2</sup>, RayTech Navigator, Sail Pilot, SeaTalk, SeaTalk<sup>NG</sup>, SeaTalk<sup>HS</sup> and Sportpilot are registered trademarks of Raymarine UK Limited. RayTalk, Seahawk, Smartpilot, Pathfinder and Raymarine are registered trademarks of Raymarine Holdings Limited.

FLIR is a registered trademark of FLIR Systems, Inc. and/or its subsidiaries.

All other trademarks, trade names, or company names referenced herein are used for identification only and are the property of their respective owners.

This product is protected by patents, design patents, patents pending, or design patents pending.

## **Fair Use Statement**

You may print no more than three copies of this manual for your own use. You may not make any further copies or distribute or use the manual in any other way including without limitation exploiting the manual commercially or giving or selling copies to third parties.

## **Software updates**

Check the website [www.raymarine.com](http://www.raymarine.com) for the latest software releases for your product.

## **Product handbooks**

The latest versions of all English and translated handbooks are available to download in PDF format from the website [www.raymarine.com](http://www.raymarine.com).

Please check the website to ensure you have the latest handbooks.

**Copyright ©2014 Raymarine UK Ltd. All rights reserved.**



# Contents

<b>Chapter 1 Important information.....</b>	<b>7</b>	7.7 Switching the depth and speed position.....	42
Certified Installation .....	7	7.8 Using the depth pages.....	43
Water ingress .....	7	7.9 Using the speed pages.....	43
Disclaimer .....	7	<b>Chapter 8 i40 Depth.....</b>	<b>45</b>
EMC installation guidelines .....	7	8.1 i40 Depth operation .....	46
Suppression ferrites .....	8	8.2 Calibration .....	46
Connections to other equipment .....	8	8.3 User calibration — i40 Depth .....	47
Declaration of conformity.....	8	8.4 Intermediate calibration .....	48
Product disposal.....	8	8.5 Dealer calibration .....	48
Warranty registration.....	8	8.6 Using the depth pages.....	49
IMO and SOLAS.....	8	<b>Chapter 9 i40 Speed .....</b>	<b>51</b>
Technical accuracy .....	9	9.1 i40 Speed operation .....	52
<b>Chapter 2 Document and product information.....</b>	<b>11</b>	9.2 Calibration .....	52
2.1 Document information .....	12	9.3 User calibration — i40 Speed.....	53
2.2 Parts supplied .....	13	9.4 Intermediate calibration .....	54
2.3 i40 Product overview .....	13	9.5 Dealer calibration .....	54
<b>Chapter 3 Planning the installation .....</b>	<b>15</b>	9.6 Using the speed pages.....	55
3.1 Installation checklist .....	16	<b>Chapter 10 i40 Wind .....</b>	<b>57</b>
3.2 Compatible transducers.....	16	10.1 i40 Wind operation .....	58
3.3 Typical systems .....	18	10.2 Calibration .....	58
3.4 Tools required .....	19	10.3 User calibration — i40 Wind.....	59
3.5 Selecting a display location.....	19	10.4 Intermediate calibration .....	60
3.6 Selecting a transducer location .....	20	10.5 Dealer calibration .....	60
<b>Chapter 4 Cables and connections.....</b>	<b>23</b>	10.6 True and apparent wind pages .....	61
4.1 General cabling guidance .....	24	10.7 Using the wind pages .....	61
4.2 Power connection .....	24	<b>Chapter 11 Alarms .....</b>	<b>63</b>
4.3 Connections .....	25	11.1 Alarms.....	64
4.4 SeaTalk <sup>ng</sup> connection .....	27	<b>Chapter 12 Maintaining your display.....</b>	<b>65</b>
<b>Chapter 5 Location and mounting .....</b>	<b>29</b>	12.1 Service and maintenance .....	66
5.1 Mounting .....	30	12.2 Condensation.....	66
5.2 Bracket mounting .....	30	12.3 Routine equipment checks.....	67
5.3 Front bezel .....	31	12.4 Cleaning .....	67
5.4 Rotavecta mounting .....	32	12.5 Cleaning the display case .....	68
<b>Chapter 6 Getting started .....</b>	<b>33</b>	12.6 Cleaning the display screen .....	68
6.1 Controls.....	34	<b>Chapter 13 Troubleshooting.....</b>	<b>69</b>
6.2 Power .....	34	13.1 Troubleshooting .....	70
6.3 Data master.....	35	13.2 Instrument troubleshooting.....	71
6.4 Adjusting the backlight.....	35	13.3 Power up troubleshooting .....	73
6.5 Adjusting the contrast.....	36	13.4 Miscellaneous troubleshooting .....	74
6.6 Pages .....	36	<b>Chapter 14 Technical support .....</b>	<b>75</b>
<b>Chapter 7 i40 Bidata .....</b>	<b>37</b>	14.1 Raymarine customer support .....	76
7.1 i40 Bidata operation .....	38	<b>Chapter 15 Technical specification.....</b>	<b>77</b>
7.2 i40 Bidata Display .....	38	15.1 Technical specification .....	78
7.3 Calibration .....	39	15.2 Operating ranges .....	79
7.4 User calibration — i40 Bidata.....	39	<b>Chapter 16 Spares and accessories .....</b>	<b>81</b>
7.5 Intermediate calibration .....	41	16.1 Accessories .....	82
7.6 Dealer calibration .....	42		

16.2 Spares.....	82
16.3 SeaTalk accessories.....	83
16.4 SeaTalk power cables.....	83
16.5 Converters.....	84

# Chapter 1: Important information

## Certified Installation

Raymarine recommends certified installation by a Raymarine approved installer. A certified installation qualifies for enhanced product warranty benefits. Contact your Raymarine dealer for further details, and refer to the separate warranty document packed with your product.



### Warning: Product installation and operation

This product must be installed and operated in accordance with the instructions provided. Failure to do so could result in personal injury, damage to your vessel and/or poor product performance.



### Warning: Potential ignition source

This product is NOT approved for use in hazardous/flammable atmospheres. Do NOT install in a hazardous/flammable atmosphere (such as in an engine room or near fuel tanks).



### Warning: Positive ground systems

Do not connect this unit to a system which has positive grounding.

### Caution: Power supply protection

When installing this product ensure the power source is adequately protected by means of a suitably-rated fuse or automatic circuit breaker.



### Warning: Switch off power supply

Ensure the vessel's power supply is switched OFF before starting to install this product. Do NOT connect or disconnect equipment with the power switched on, unless instructed in this document.



### Warning: High voltage

This product contains high voltage. Adjustments require specialized service procedures and tools only available to qualified service technicians. There are no user serviceable parts or adjustments. The operator should never remove the cover or attempt to service the product.

### Caution: Transducer cable

- Do NOT cut, shorten, or splice the transducer cable.
- Do NOT remove the connector.

If the cable is cut, it cannot be repaired. Cutting the cable will also void the warranty.

### Caution: Service and maintenance

This product contains no user serviceable components. Please refer all maintenance and repair to authorized Raymarine dealers. Unauthorized repair may affect your warranty.

## Water ingress

### Water ingress disclaimer

Although the waterproof rating capacity of this product meets the stated IPX standard (refer to the product's *Technical Specification*), water intrusion and subsequent equipment failure may occur if the product is subjected to commercial high-pressure washing. Raymarine will not warrant products subjected to high-pressure washing.

## Disclaimer

Raymarine does not warrant that this product is error-free or that it is compatible with products manufactured by any person or entity other than Raymarine.

Raymarine is not responsible for damages or injuries caused by your use or inability to use the product, by the interaction of the product with products manufactured by others, or by errors in information utilized by the product supplied by third parties.

## EMC installation guidelines

Raymarine equipment and accessories conform to the appropriate Electromagnetic Compatibility (EMC) regulations, to minimize electromagnetic interference between equipment and minimize the effect such interference could have on the performance of your system

Correct installation is required to ensure that EMC performance is not compromised.

**Note:** In areas of extreme EMC interference, some slight interference may be noticed on the product. Where this occurs the product and the source of the interference should be separated by a greater distance.

For **optimum** EMC performance we recommend that wherever possible:

- Raymarine equipment and cables connected to it are:

- At least 1 m (3 ft) from any equipment transmitting or cables carrying radio signals e.g. VHF radios, cables and antennas. In the case of SSB radios, the distance should be increased to 7 ft (2 m).
- More than 2 m (7 ft) from the path of a radar beam. A radar beam can normally be assumed to spread 20 degrees above and below the radiating element.
- The product is supplied from a separate battery from that used for engine start. This is important to prevent erratic behavior and data loss which can occur if the engine start does not have a separate battery.
- Raymarine specified cables are used.
- Cables are not cut or extended, unless doing so is detailed in the installation manual.

**Note: Where constraints on the installation prevent any of the above recommendations, always ensure the maximum possible separation between different items of electrical equipment, to provide the best conditions for EMC performance throughout the installation**

## Suppression ferrites

Raymarine cables may be fitted with suppression ferrites. These are important for correct EMC performance. If a ferrite has to be removed for any purpose (e.g. installation or maintenance), it must be replaced in the original position before the product is used.

Use only ferrites of the correct type, supplied by Raymarine authorized dealers.

Where an installation requires multiple ferrites to be added to a cable, additional cable clips should be used to prevent stress on the connectors due to the extra weight of the cable.

## Connections to other equipment

Requirement for ferrites on non-Raymarine cables

If your Raymarine equipment is to be connected to other equipment using a cable not supplied by Raymarine, a suppression ferrite **MUST** always be attached to the cable near the Raymarine unit.

### Caution: Sun covers

- To protect your product against the damaging effects of ultraviolet (UV) light, always fit the sun covers when the product is not in use.
- Remove the sun covers when travelling at high speed, whether in water or when the vessel is being towed.

### Caution: Cleaning

When cleaning this product:

- Do NOT wipe the display screen with a dry cloth, as this could scratch the screen coating.
- Do NOT use abrasive, or acid or ammonia based products.
- Do NOT use a jet wash.

### Caution: Condensation

Certain atmospheric conditions may cause a small amount of condensation to form on the unit's window. This will not damage the unit and will clear after the unit has been switched on for a short period.

## Declaration of conformity

Raymarine UK Ltd. declares that this product is compliant with the essential requirements of EMC directive 2004/108/EC.

The original Declaration of Conformity certificate may be viewed on the relevant product page at [www.raymarine.com](http://www.raymarine.com).

## Product disposal

Dispose of this product in accordance with the WEEE Directive.



The Waste Electrical and Electronic Equipment (WEEE) Directive requires the recycling of waste electrical and electronic equipment. Whilst the WEEE Directive does not apply to some Raymarine products, we support its policy and ask you to be aware of how to dispose of this product.

## Warranty registration

To register your Raymarine product ownership, please visit [www.raymarine.com](http://www.raymarine.com) and register online.

It is important that you register your product to receive full warranty benefits. Your unit package includes a bar code label indicating the serial number of the unit. You will need this serial number when registering your product online. You should retain the label for future reference.

## IMO and SOLAS

The equipment described within this document is intended for use on leisure marine boats and workboats NOT covered by International Maritime Organization (IMO) and Safety of Life at Sea (SOLAS) Carriage Regulations.



## Technical accuracy

To the best of our knowledge, the information in this document was correct at the time it was produced. However, Raymarine cannot accept liability for any inaccuracies or omissions it may contain. In addition, our policy of continuous product improvement may change specifications without notice. As a result, Raymarine cannot accept liability for any differences between the product and this document. Please check the Raymarine website ([www.raymarine.com](http://www.raymarine.com)) to ensure you have the most up-to-date version(s) of the documentation for your product.



## Chapter 2: Document and product information

### Chapter contents

- [2.1 Document information on page 12](#)
- [2.2 Parts supplied on page 13](#)
- [2.3 i40 Product overview on page 13](#)

## 2.1 Document information

This document contains important information related to the installation of your Raymarine product.

The document includes information to help you:

- plan your installation and ensure you have all the necessary equipment;
- install and connect your product as part of a wider system of connected marine electronics;
- troubleshoot problems and obtain technical support if required.

This and other Raymarine product documents are available to download in PDF format from [www.raymarine.com](http://www.raymarine.com).

### Applicable products

This document is applicable to the following products:

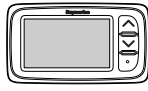
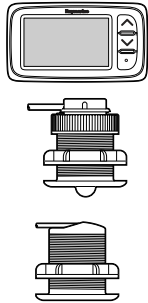
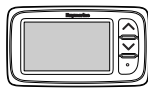
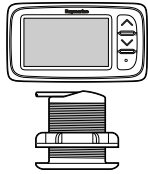
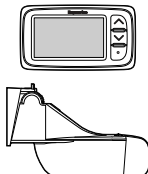
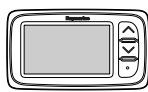
Item	Model	Part number	Hardware
	i40 Bidata	E70066	i40 Bidata SeaTalk instrument display
	i40 Bidata Thru-hull system pack	E70145	<ul style="list-style-type: none"> <li>• i40 Bidata SeaTalk instrument display</li> <li>• P7 Thru-hull Depth transducer</li> <li>• P371 Thru-hull Speed and Temp transducer</li> </ul>
	i40 Depth	E70064	i40 Depth SeaTalk instrument display
	i40 Depth Thru-hull system pack	E70142	<ul style="list-style-type: none"> <li>• i40 Depth SeaTalk instrument display</li> <li>• P7 Thru-hull Depth transducer</li> </ul>
	i40 Depth Transom mount system pack	E70143	<ul style="list-style-type: none"> <li>• i40 Depth SeaTalk instrument display</li> <li>• P66 Transom mount Depth transducer</li> </ul>
	i40 Speed	E70063	i40 Speed SeaTalk instrument display

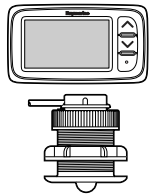
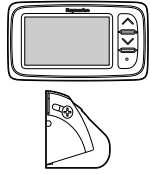
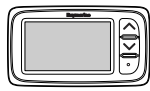
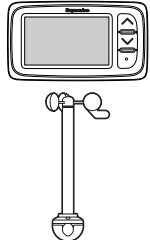
Item	Model	Part number	Hardware
	i40 Speed Thru-hull system pack	E70140	<ul style="list-style-type: none"> <li>• i40 Speed SeaTalk instrument display</li> <li>• P371 Thru-hull Speed and Temp transducer</li> </ul>
	i40 Speed Transom mount system pack	E70141	<ul style="list-style-type: none"> <li>• i40 Speed SeaTalk instrument display</li> <li>• ST69 Transom mount Speed and Temp transducer</li> </ul>
	i40 Wind	E70065	i40 Wind SeaTalk instrument display
	i40 Wind system pack	E70144	<ul style="list-style-type: none"> <li>• i40 Wind SeaTalk instrument display</li> <li>• Rotavecta wind transducer</li> </ul>

### Document illustrations

Your product may differ slightly from that shown in the illustrations in this document, depending on product variant and date of manufacture.

All images are provided for illustration purposes only.

### Product documentation

The following documentation is applicable to your product:

#### Handbooks

Description	Part number
<b>i40 Installation and operation instructions</b> Installation and operation instructions for the i40 instrument display	81340 / 88006
<b>i40 Mounting template</b> Surface mounting template for the i40 instrument display	87155
<b>Rotavecta Installation instructions</b> Installation instructions for the Rotavecta wind transducer	87221 / 88036
<b>Depth and Speed Transducer installation instructions</b> Installation instructions for speed and depth transducers, as supplied with your transducer	

## 2.2 Parts supplied

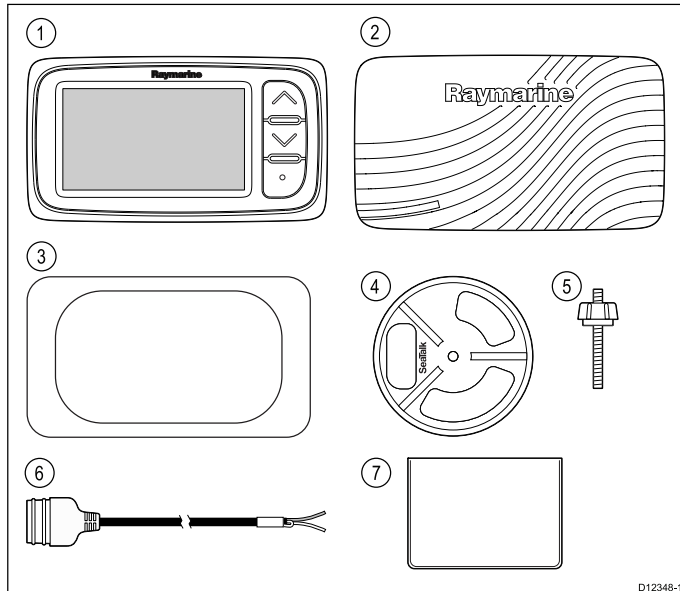

1	i40 Instrument
2	i40 Sun cover
3	Mounting gasket
4	Clamping bracket
5	Fixing stud and thumb nut
6	SeaTalk power cable
7	Document pack

## 2.3 i40 Product overview

The i40 range of SeaTalk instrument displays can be connected directly to the relevant transducers. The data can be transmitted on the SeaTalk network to other compatible displays.

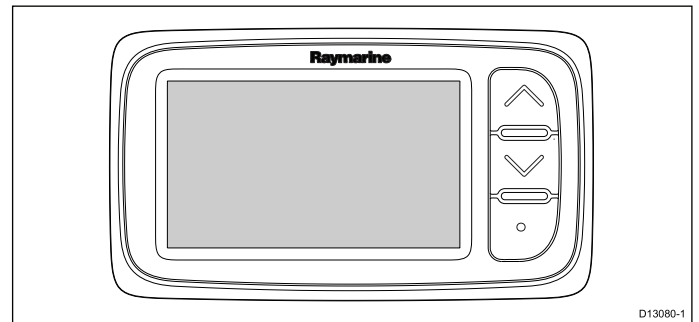

The i40 instrument display range offers the following features:

- Integrates with Raymarine autopilots and navigation equipment
- Surface or bracket (trunnion) mountable
- Extra large (28 mm max) digits
- Provides good visibility in all lighting conditions
- Low power consumption



# Chapter 3: Planning the installation

## Chapter contents

- 3.1 Installation checklist on page 16
- 3.2 Compatible transducers on page 16
- 3.3 Typical systems on page 18
- 3.4 Tools required on page 19
- 3.5 Selecting a display location on page 19
- 3.6 Selecting a transducer location on page 20

### 3.1 Installation checklist

Installation includes the following activities:

Installation Task	
1	Plan your system.
2	Obtain all required equipment and tools.
3	Site all equipment.
4	Route all cables.
5	Drill cable and mounting holes.
6	Make all connections into equipment.
7	Secure all equipment in place.
8	Power on and test the system.

### Schematic diagram

A schematic diagram is an essential part of planning any installation. It is also useful for any future additions or maintenance of the system. The diagram should include:

- Location of all components.
- Connectors, cable types, routes and lengths.

### 3.2 Compatible transducers

#### Instrument Depth transducers

The depth transducers listed below are compatible with the following instrument displays:

- i40 Depth / i40 Bidata
- i50 Depth / i50 Tridata
- i70 via iTC-5 converter

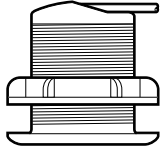
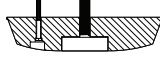
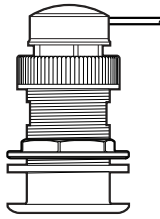
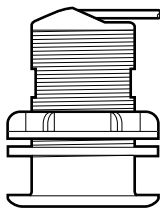
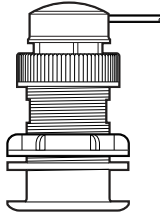
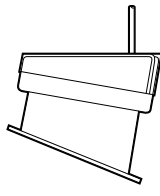
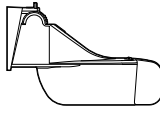
Part number	Image	Mounting	Housing
E26009		Thru-hull	P7
E26019-PZ		Thru-hull	B45 (including fairing block)
M78717		Thru-hull	B17
M78713-PZ		Thru-hull	P319
E26030		Thru-hull	P17
E26001-PZ		In-hull	P79
E26027-PZ		Transom mount	P66

#### Instrument Speed and Temperature transducers

The speed and temperature transducers listed below are compatible with the following instrument displays:

- i40 Speed / i40 Bidata
- i50 Speed / i50 Tridata
- i70 via iTC-5 converter

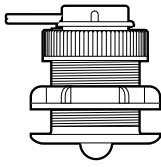
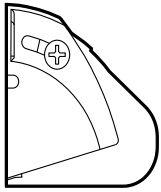
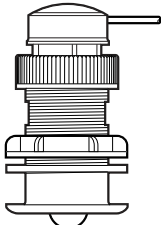
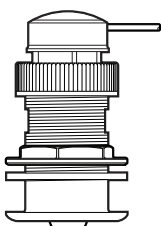
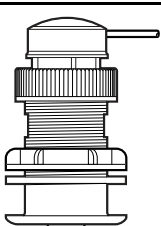

Part number	Image	Mounting	Housing
E26008		Thru-hull	P371
E26005		Transom mount	ST69
E26031		Thru-hull	P120 / ST800
M78716		Thru-hull	B120
E25025		Thru-hull	P17

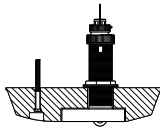
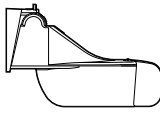
Part number	Image	Mounting	Housing
A26044		Thru-hull	B744VL (including fairing block)
E26028-PZ		Transom mount	P66

### Instrument Rotavecta transducer

The wind transducers listed below are compatible with the following instrument displays:

- i40 Wind
- i60 Wind
- i70 via iTC-5 converter

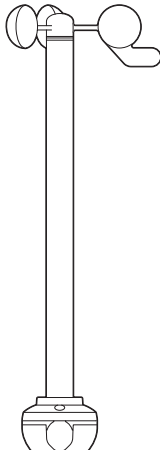
Part number	Image	Housing	Mounting
Z195		Rotavecta transducer	Surface mount

### Instrument Depth, Speed and Temperature (DST) transducers

The DST transducers listed below are compatible with the following instrument displays:

- i40 Depth / i40 Speed / i40 Bidata
- i50 Depth i50 Speed / i50 Tridata
- i70 via iTC-5 converter

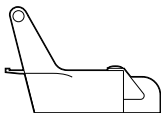
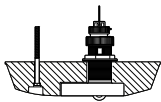
Part number	Image	Mounting	Housing
E26006-PZ		Transom mount	P66 / ST40
A26043		Thru-hull	B744V (including fairing block)

### 3.3 Typical systems

#### Basic SeaTalk system

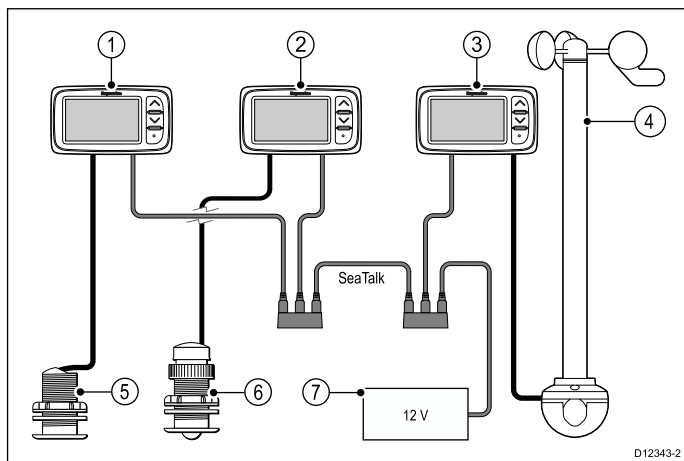

1	i40 Depth instrument display
2	i40 Speed instrument display
3	i40 Wind instrument display
4	Rotavecta wind transducer
5	Depth transducer
6	Speed transducer
7	12 V dc power supply

#### Basic SeaTalk<sup>ng</sup> system

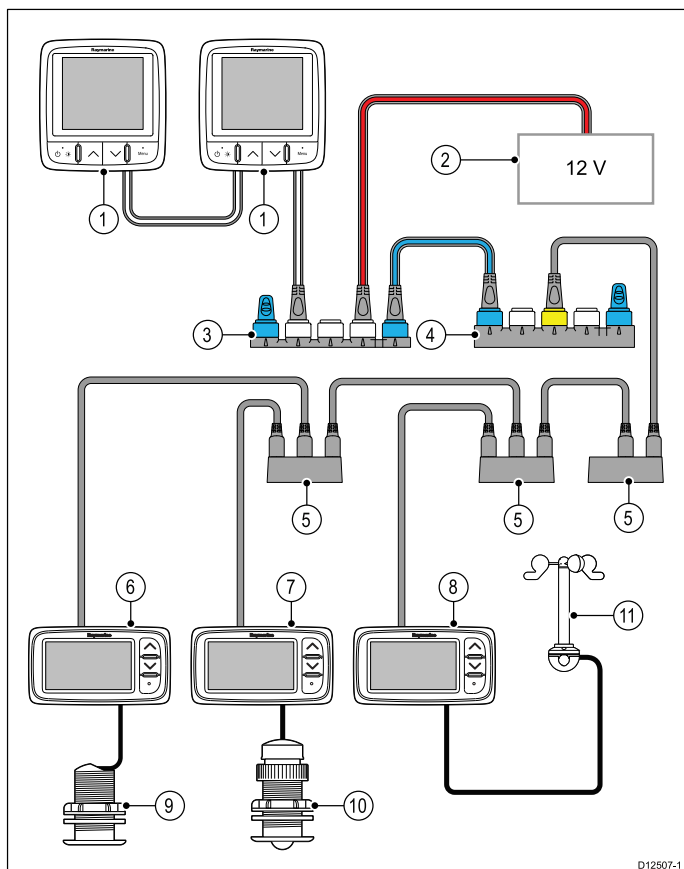

1	SeaTalk <sup>ng</sup> instrument displays
2	12 V dc power supply
3	SeaTalk <sup>ng</sup> 5 way block
4	SeaTalk to SeaTalk <sup>ng</sup> converter
5	SeaTalk 3 way blocks

6	i40 Depth instrument
7	i40 Speed instrument
8	i40 Wind instrument
9	Depth transducer
10	Speed transducer
11	Rotavecta wind transducer

#### SeaTalk

SeaTalk is a protocol which enables compatible instruments to connect to each other and share data.

The SeaTalk cable system is used to connect compatible instruments and equipment. The cable carries power and data and enables connection without the need for a central processor.

Additional instruments and functions can be added to a SeaTalk system, simply by plugging them into the network. SeaTalk equipment can also communicate with other non-SeaTalk equipment via the NMEA 0183 standard, provided a suitable interface is used.

### 3.4 Tools required

#### Tools required for installation

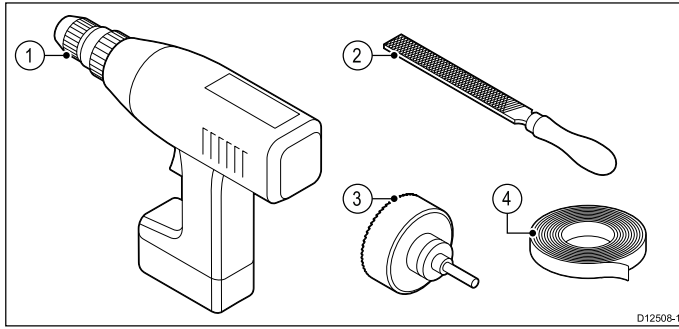

1	Power drill
2	File
3	57 mm (2.25 in) hole cutter
4	Adhesive tape

### 3.5 Selecting a display location



#### Warning: Potential ignition source

This product is NOT approved for use in hazardous/flammable atmospheres. Do NOT install in a hazardous/flammable atmosphere (such as in an engine room or near fuel tanks).

#### General location requirements

When selecting a location for the unit it is important to consider a number of factors.

#### Ventilation requirements

To provide adequate airflow:

- Ensure that equipment is mounted in a compartment of suitable size.
- Ensure that ventilation holes are not obstructed.
- Ensure adequate separation of equipment.

#### Mounting surface requirements

Ensure units are adequately supported on a secure surface. Do NOT mount units or cut holes in places which may damage the structure of the vessel.

#### Cable routing requirements

Ensure the unit is mounted in a location which allows proper routing and connection of cables:

- Minimum cable bend radius of 100 mm (3.94 in) is required unless otherwise stated.
- Use cable supports to prevent stress on connectors.

#### Electrical interference

Select a location that is far enough away from devices that may cause interference, such as motors, generators and radio transmitters/receivers.

#### Magnetic compass

When choosing a suitable location you should aim to maintain the maximum possible distance between the unit and any compasses.

To prevent potential interference with the vessel's magnetic compasses, ensure that a minimum distance of 230 mm (9 in) between the unit and any installed compasses is maintained.

#### Viewing angle considerations

As display contrast, color and night mode performance are all affected by the viewing angle, Raymarine recommends you temporarily power up the display when planning the installation, to enable you to best judge which location gives the optimum viewing angle.

## Viewing angle

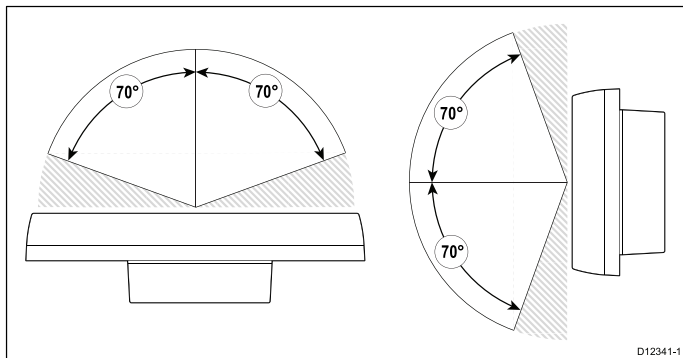

## Product dimensions

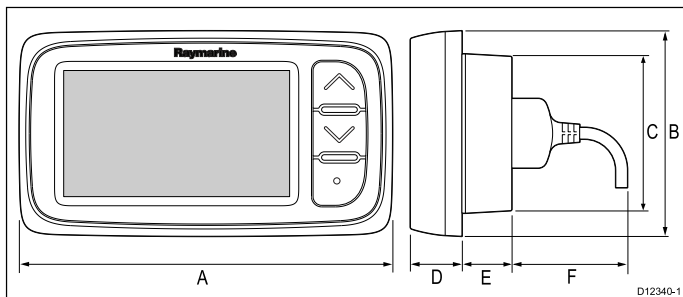

A	128 mm (5.04 in)
B	72 mm (2.83 in)
C	55 mm (2.17 in)
D	18 mm (0.7 in)
E	17 mm (0.67 in)
F	30 mm (1.18 in)

## 3.6 Selecting a transducer location

### General speed and depth transducer location requirements

When selecting a location for your transducer it is important to consider a number of factors.

The transducer should be mounted within the clear water flow areas indicated by the shaded areas in the image below.

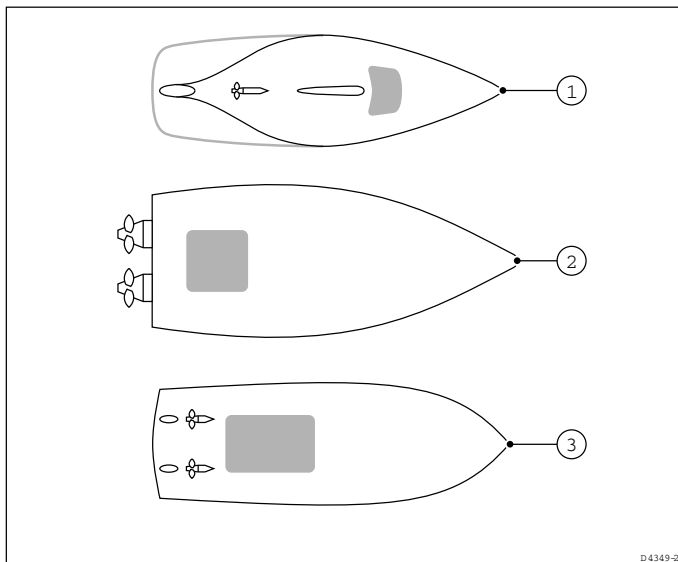

1	Sailing vessel
2	Planing power vessel
3	Displacement power vessel

Each transducer should also:

- Be ahead of the propellers (by a minimum of 10% of the water line length).
- Be at least 150 mm (6 in) away from the keel (ideally ahead of the keel on a sailing yacht).
- Be as near as possible to the center line of the vessel.
- Be clear of other through-hull fittings or projections.
- Have sufficient clearance inside the hull to fit the nut.
- Have 100 mm (4 in) of headroom to allow for withdrawal.

**Note:** In addition to the above requirements, the depth transducer must be mounted within 10° of the vertical.

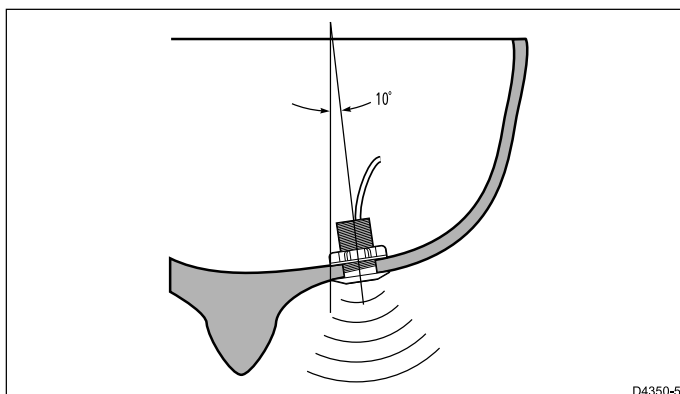

## **Speed and depth transducer mounting**

Ensure transducers are installed in accordance with the instructions supplied with the transducer.

## **Wind vane transducer / rotavecta location requirements**

When selecting a location for your wind transducer it is important to consider a number of factors.

The transducer's location must:

- Allow reasonable access for installation and servicing.
- Be as high as possible and away from any equipment which may shield the transducer or otherwise disturb the air flow.
- Provide a horizontal mounting surface. If a surface (e.g. mast top) is otherwise suitable but not horizontal, make up a suitable wedged packing piece to provide the necessary horizontal surface.
- There must also be a viable route for the transducer cable to be routed to the product it is to be connected to (i.e. display or converter).



# Chapter 4: Cables and connections

## Chapter contents

- [4.1 General cabling guidance on page 24](#)
- [4.2 Power connection on page 24](#)
- [4.3 Connections on page 25](#)
- [4.4 SeaTalk<sup>ng</sup> connection on page 27](#)

## 4.1 General cabling guidance

### Cable types and length

It is important to use cables of the appropriate type and length

- Unless otherwise stated use only standard cables of the correct type, supplied by Raymarine.
- Ensure that any non-Raymarine cables are of the correct quality and gauge. For example, longer power cable runs may require larger wire gauges to minimize voltage drop along the run.

### Routing cables

Cables must be routed correctly, to maximize performance and prolong cable life.

- Do NOT bend cables excessively. Wherever possible, ensure a minimum bend diameter of 200 mm (8 in) / minimum bend radius of 100 mm (4 in).

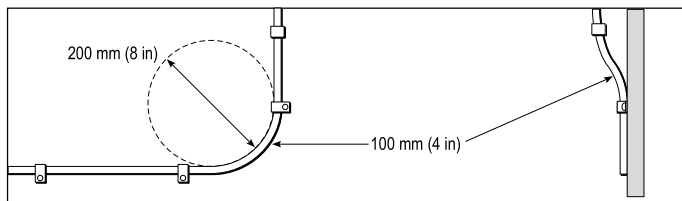

- Protect all cables from physical damage and exposure to heat. Use trunking or conduit where possible. Do NOT run cables through bilges or doorways, or close to moving or hot objects.
- Secure cables in place using tie-wraps or lacing twine. Coil any extra cable and tie it out of the way.
- Where a cable passes through an exposed bulkhead or deckhead, use a suitable watertight feed-through.
- Do NOT run cables near to engines or fluorescent lights.

Always route data cables as far away as possible from:

- other equipment and cables,
- high current carrying ac and dc power lines,
- antennae.

### Strain relief

Ensure adequate strain relief is provided. Protect connectors from strain and ensure they will not pull out under extreme sea conditions.

### Cable shielding

Ensure that all data cables are properly shielded that the cable shielding is intact (e.g. hasn't been scraped off by being squeezed through a tight area).

## 4.2 Power connection

Power can be supplied to the unit either directly or as part of the SeaTalk network.

A SeaTalk system requires one 12 V dc supply, connected to the SeaTalk backbone. This can be provided:

- By a battery via the distribution panel, or
- From a Raymarine course computer, via SeaTalk or SeaTalk<sup>ng</sup>.



### Warning: Grounding not required

This product is fully insulated and does NOT require separate grounding.



### Warning: Positive ground systems

Do not connect this unit to a system which has positive grounding.

### Power connection example

#### Direct power connection

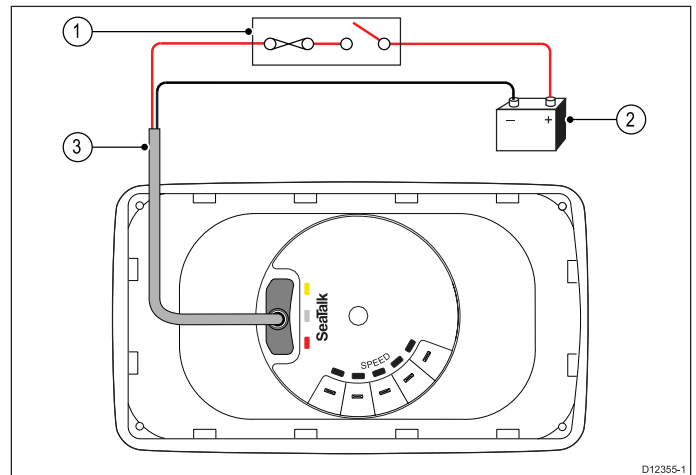

1	3 A circuit breaker or fuse
2	12 V dc vessel power supply
3	SeaTalk power cable

#### SeaTalk power connection

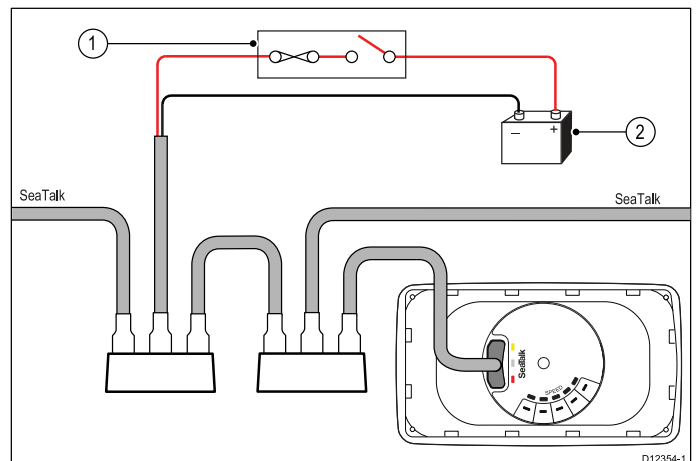

1	5 A circuit breaker or fuse.
2	12 V dc vessel power supply.



## SeaTalk power cables

Part number	Description
D229	SeaTalk power cable.

### Power cable extension (12 V)

The following restrictions apply to any extension to the power cable:

- Cable must be of a suitable gauge for the circuit load.
- Cable must be wired back to the distribution panel.

Total length (max)	Cable gauge (AWG)
0 to 5 m (0 to 16.4 ft)	18
5 to 10 m (16.4 to 32.8 ft)	14
10 to 15 m (32.8 to 49.2 ft)	12
15 to 20 m (49.2 to 65.5 ft)	12

### SeaTalk power protection

The power supply must be protected by a 5 A fuse or a circuit breaker providing equivalent protection.

Raymarine recommends that the power is connected to a SeaTalk system in such a way that the current drawn on each side of the power connection point is equal.

## 4.3 Connections

### SeaTalk connection

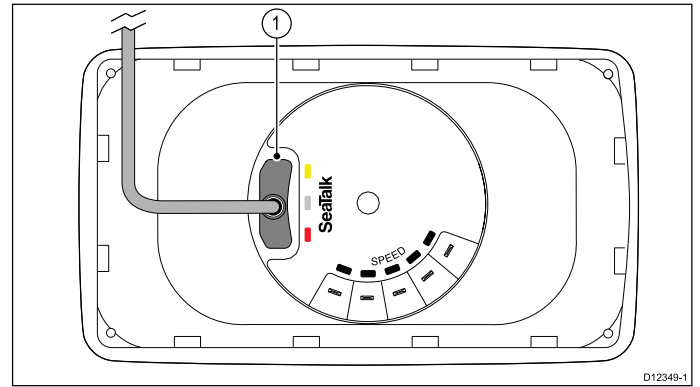

1	SeaTalk connection
---	--------------------

### i40 Bidata connection

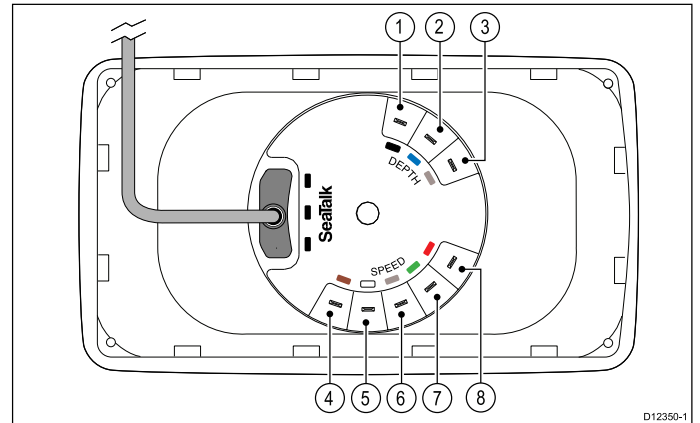

Item	Cable color	Signal name
1	Black (Depth)	Piezoceramic -
2	Blue (Depth)	Piezoceramic +
3	Screen (Depth)	0 V (shield)
4	Brown (Speed)	Temperature 0 V
5	White (Speed)	Temperature (signal)
6	Screen (Speed)	Speed 0 V (shield)
7	Green (Speed)	Speed (signal)
8	Red (Speed)	Speed V+

### i40 Depth connection

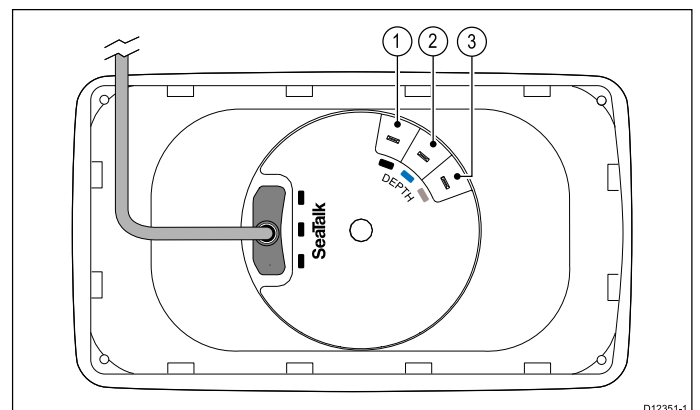

Item	Cable color	Signal name
1	Black	Piezoceramic –
2	Blue	Piezoceramic +
3	Screen	0 V (shield)

### i40 Speed connection

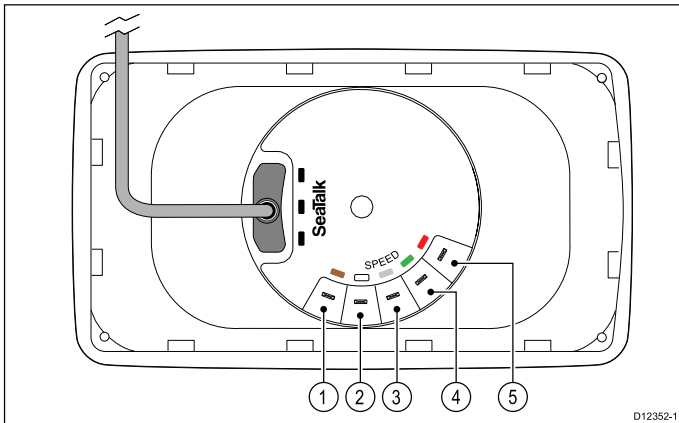

Item	Cable color	Signal name
1	Brown	Temperature 0 V
2	White	Temperature (signal)
3	Screen	Speed 0 V (shield)
4	Green	Speed (signal)
5	Red	Speed V+

### i40 Wind connection

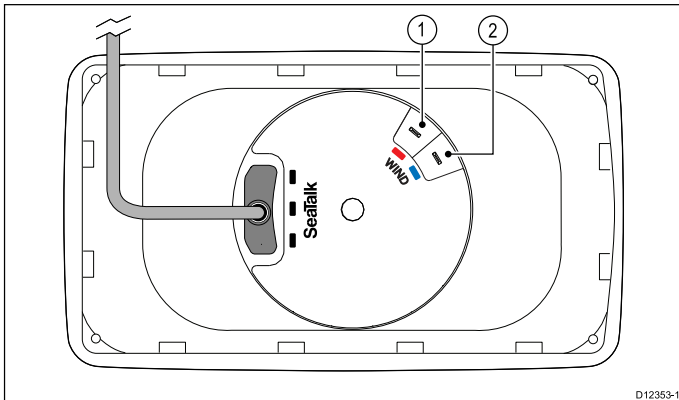

Item	Cable color	Signal name
1	Red	Rotor +
2	Blue	Rotor –

### Making transducer connections

Although the transducer cable is fitted with spade connectors for direct connection to the rear of the unit, it may be necessary to remove these to facilitate installation, e.g. if the cable has to be routed through narrow apertures. 1/8th spade terminals will be

required (not supplied), to replace those removed. When fitting the new spade connectors, prepare the cables as detailed below:

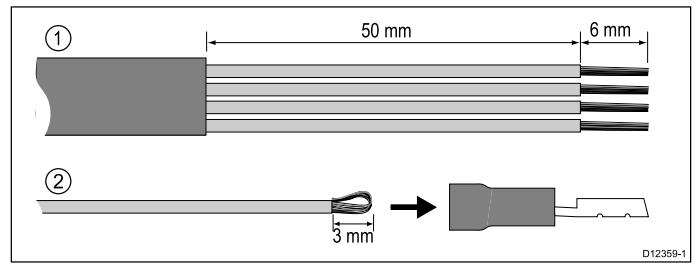

1. Prepare the cable as shown in 1 above.
2. Fold back the wire strands and insert into the new spade connector as shown in 2 above.
3. Ensure the wire strands do not extend beyond the rear of the spade connector insulation.
4. Crimp the connector to the wire.

## 4.4 SeaTalk<sup>ng</sup> connection

You can connect your SeaTalk product to a SeaTalk<sup>ng</sup> system using the SeaTalk to SeaTalk<sup>ng</sup> converter.

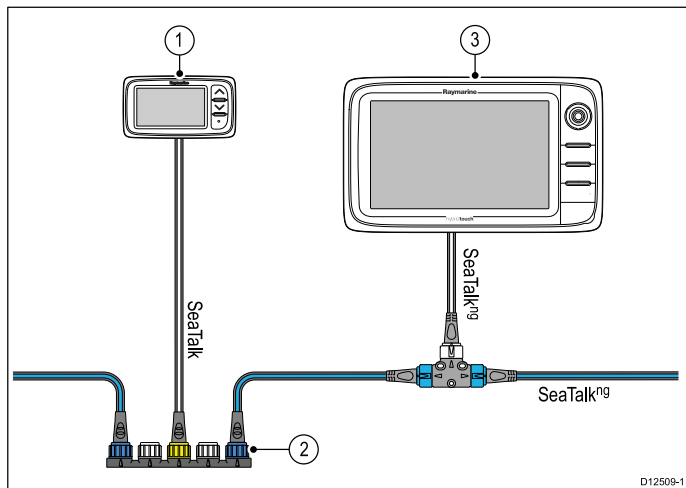

1	i40 instrument
2	SeaTalk to SeaTalk <sup>ng</sup> converter
3	Raymarine multifunction display



# Chapter 5: Location and mounting

## Chapter contents

- [5.1 Mounting on page 30](#)
- [5.2 Bracket mounting on page 30](#)
- [5.3 Front bezel on page 31](#)
- [5.4 Rotavecta mounting on page 32](#)

## 5.1 Mounting

### Pre-mounting check

The product is designed to be surface mounted. Before mounting the unit, ensure you have:

- Selected a suitable location.
- Identified the cable connections and route that the cables will take.

### Mounting diagram

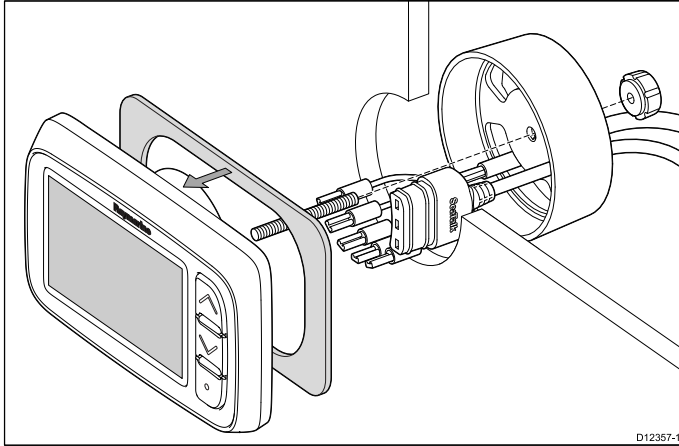

### Mounting instructions

1. Check the selected location for the unit. A clear, flat area with suitable clearance behind the panel is required.
2. Fix the supplied mounting template to the selected location, using masking or self adhesive tape.
3. If possible use an appropriate size hole cutting saw to cut-out the center hole area as indicated on the mounting template; or
4. Using a suitable hole cutting saw, make pilot holes in each corner of the cut-out area, and using a jigsaw cut along the inside edge of the cut-out line.
5. Ensure that the unit fits into the removed area and then file around the cut edge until smooth.
6. Peel the backing off the supplied gasket and place the adhesive side of the gasket onto the display unit and press firmly onto the flange.
7. Screw the supplied mounting stud into the back of the unit.
8. Feed cables through the supplied clamping bracket and connect to the unit.
9. Secure the instrument and bracket using the thumb nut and stud.

## 5.2 Bracket mounting

To bracket mount the unit, follow the instructions supplied with the mounting bracket (Part number E25024).

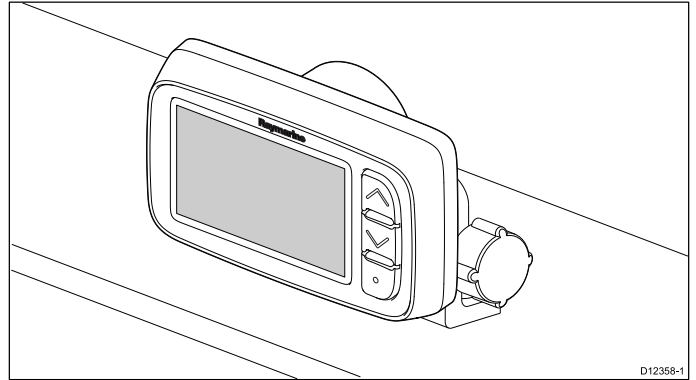

## 5.3 Front bezel

### Removing the front bezel

**Note:** You do not need to remove the front bezel when mounting the unit.

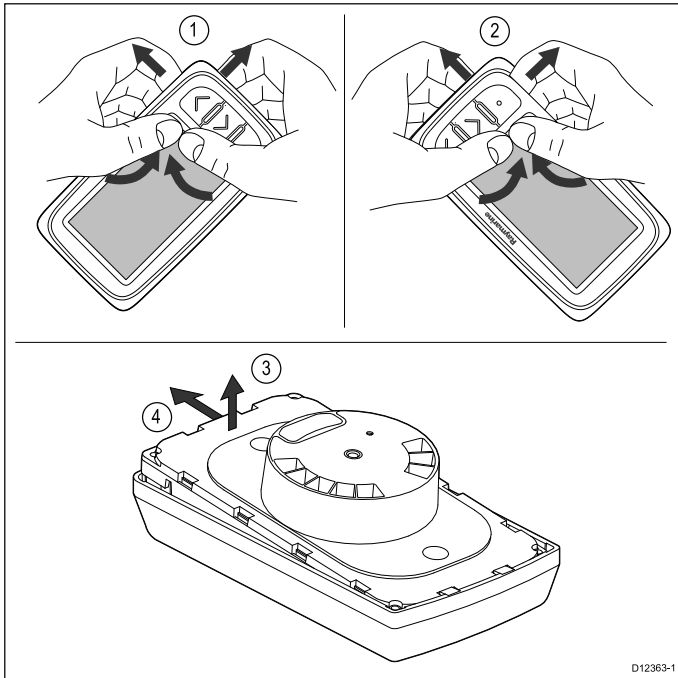

1. Remove the unit from the mounting surface or mounting bracket and disconnect the cables.
2. Using your fingers pull the bezel up and away from the unit at the top corner, nearest the buttons, as shown in 1.  
The bezel will start to come away from the unit at the top corner.
3. Using your fingers pull the bezel up and away from the unit at the bottom corner, nearest the buttons, as shown in 2.
4. Pull the unit away from the bezel and slide unit away from lugs on opposite side of the bezel, as shown in 3 and 4.

The bezel will now come free from the unit.

**Important:** Use care when removing the bezel. Do not use any tools to lever the bezel, doing so may cause damage.

### Fitting the front bezel

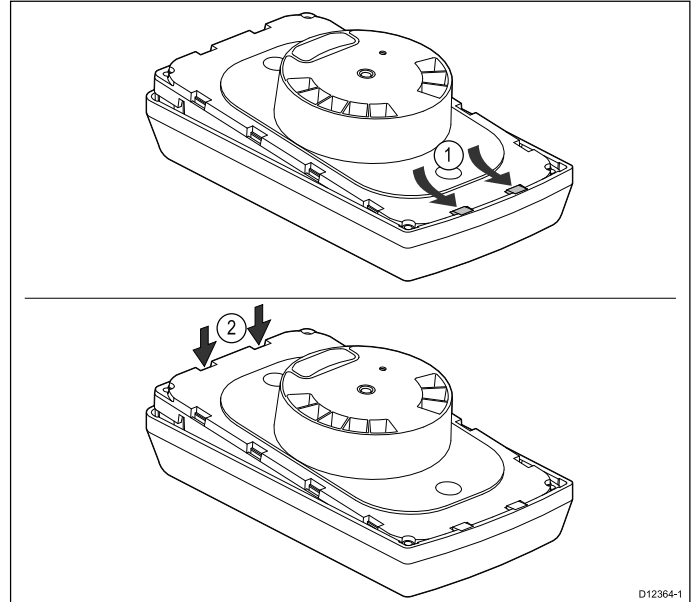

1. Ensure the keymat is positioned correctly.
2. Fit the unit into the bezel so that the unit slides under the lugs on the bezel, as shown in 1.
3. Gently but firmly press the bezel onto the unit until it clicks into place, as shown in 2.
4. Follow the mounting instructions to refit the unit on to the mounting surface.

## **5.4 Rotavecta mounting**

The Rotavecta wind transducer should be mounted in accordance with the installation instruction. that accompanied the transducer.

Please refer to installation instructions 87221 or 88036 for detailed instructions on how to install your Rotavecta wind transducer.



# Chapter 6: Getting started

## Chapter contents

- [6.1 Controls on page 34](#)
- [6.2 Power on page 34](#)
- [6.3 Data master on page 35](#)
- [6.4 Adjusting the backlight on page 35](#)
- [6.5 Adjusting the contrast on page 36](#)
- [6.6 Pages on page 36](#)

## 6.1 Controls

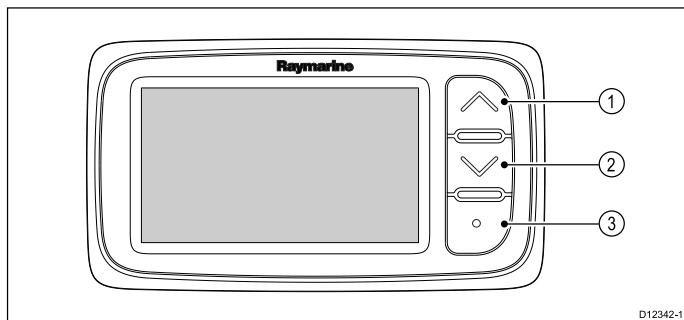

1	Up
2	Down
3	Action

## 6.2 Power

Once the power supply is connected and turned on the unit will power up. When the power supply is switched off the unit will power off.

## 6.3 Data master

Where a system contains more than one unit capable of displaying a data type (e.g. depth can be displayed on the i40 Depth and i40 Bidata), the unit physically connected to the transducer must be set as the data master and any other units set as a repeater.

### Setting a unit as data master

1. Simultaneously press and hold the **Down** and **Action** buttons for 4 seconds.  
The software version page is displayed.
2. Press the **Action** button to display the instrument status.

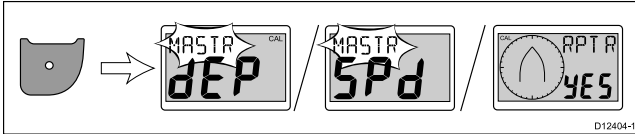

**Note:** The i40 Bidata requires an extra **Action** button push to switch from depth instrument status and speed instrument status.

3. Use the **Up** and **Down** buttons to change the instrument status between Master and Repeater.
4. To save your settings and return to normal operation from any page, simultaneously press and hold the **Down** and **Action** buttons for 2 seconds.

## 6.4 Adjusting the backlight

The backlighting can be adjusted using the **Action** button.

During normal operation:

1. Press and hold the **Action** button for approximately 1 second until the backlight page is displayed.

The backlight is turned on or if the backlight is already on:

- i40 Depth, Speed and Bidata — LAMPS and the current backlight level is displayed on-screen
  - i40 Wind — L and the current backlight level is displayed on-screen
2. Press the **Action** button again to cycle through the available backlight levels (1 to 3).
  3. To return to normal operation press the **Up** or **Down** button, or wait for 5 seconds for the page to time-out.
  4. Alternatively press and hold the **Action** button approximately 1 second to adjust the contrast level.

## 6.5 Adjusting the contrast

The contrast can be adjusted using the **Action** button.

During normal operation:

1. Press and hold the **Action** button for approximately 2 seconds until the contrast page is displayed, or from the backlight page press and hold the **Action** button for approximately 1 second.

CON and the current contrast level is displayed on-screen.

2. Press the **Action** button again to cycle through the available contrast levels (0 to 3).
3. To return to normal operation press the **Up** or **Down** button, or wait for the 5 second time-out.

## 6.6 Pages

When the unit is switched on the page displayed at last switch off will be displayed.

The pages available depend on the display variant and are shown in the table below:

** i40 Bidata	i40 Depth	i40 Speed	i40 Wind
Current depth / speed	Current depth	Current speed	Apparent wind
* Maximum speed	* Minimum depth	* Maximum speed	True wind
* Average speed	* Shallow alarm	* Average speed	* High wind speed alarm
* Log	* Deep alarm	* Log	
* Trip	* Shallow anchor alarm	* Trip	
Water temperature	* Deep anchor alarm	Water temperature	
* Minimum depth	* Depth offset		
* Shallow alarm			
* Deep alarm			
* Shallow anchor alarm			
* Deep anchor alarm			
* Depth offset			

### Note:

- \* These pages are temporary pages and will revert to the previous permanent page after 5 seconds.
- \*\* The pages available on the i40 Bidata are also dependent on which data is being displayed in the main screen area (i.e. If Depth is displayed in the main area then the pages available will be the same as an i40 Depth instrument, if Speed is displayed in the main area then the pages available will be the same as an i40 Speed instrument.

## Changing pages

During normal operation:

1. Press the **Up** or **Down** buttons to cycle through the available pages.

# Chapter 7: i40 Bidata

## Chapter contents

- 7.1 i40 Bidata operation on page 38
- 7.2 i40 Bidata Display on page 38
- 7.3 Calibration on page 39
- 7.4 User calibration — i40 Bidata on page 39
- 7.5 Intermediate calibration on page 41
- 7.6 Dealer calibration on page 42
- 7.7 Switching the depth and speed position on page 42
- 7.8 Using the depth pages on page 43
- 7.9 Using the speed pages on page 43

## 7.1 i40 Bidata operation

When connected to the relevant transducer(s) your i40 Bidata instrument:

- Provides speed information (current, maximum and average), in either knots (KTS), miles per hour (MPH) or kilometers per hour (KPH).
- Provides log and trip information. These are given in either nautical miles (NM), statute miles (M) or kilometers (KM).
- Provides water temperature information. This is given in either degrees celsius (°C) or degrees fahrenheit (°F).
- Provides depth information in either feet (FT), metres (M) or fathoms (FA).
- Records the minimum depth encountered during the period the unit is switched on. This can be reset at any time.
- Enables you to define alarm thresholds for shallow alarm, deep alarm, shallow anchor alarm and deep anchor alarm.
- Enables you to see what offset is applied to the depth reading.

**Note:** The required speed, distance, depth and water temperature units are selected during User calibration.

It should be noted that:

- Up / Down depth-trend arrows are displayed, if the seabed is rising or falling at a significant rate.
- The log screen shows the total distance covered by the vessel since the unit was fitted.
- Minimum depth, maximum speed, average speed and trip reading are reset to zero at power up.

## 7.2 i40 Bidata Display

The display is split into upper and lower data areas, each of which shows either depth or speed information, depending on user selection.

The **Current speed**, **Current depth** and **Current water temperature** pages are permanent pages, all other pages are temporary and will time-out after 5 seconds, to the last permanent page displayed.

## 7.3 Calibration

Before first use calibration procedures must be carried out to ensure optimum performance of the instrument with the vessel.

The calibration procedures are:

- User calibration
- Intermediate calibration
- Dealer calibration

## 7.4 User calibration — i40 Bidata

Calibration procedures are dependant on instrument display variant.

User calibration options include:

- Depth display response — Dictates the rate at which the instrument display responds to changes in depth data.
- Speed display response — Dictates the rate at which the instrument display responds to changes in speed data.
- \* Units for depth readings — Assigns the unit of measure used for depth related readings.
- \* Units for speed readings — Assigns the unit of measure used for speed related readings.
- \* Units for distance readings — Assigns the unit of measure used for distance related readings.
- \* Units for water temperature — Assigns the unit of measure used for temperature related readings.
- \* Correct speed reading — Assigns an offset to the speed reading.
- \* Depth offset — Assigns an offset to the depth reading.
- \* Shallow alarm lock — Locks the Shallow alarm.

**Note:** \* These settings are only available on units when the instrument status set to Master (see Intermediate Calibration for details of changing the display to be Master or Repeater).

### Depth Offset

Depths are measured from the transducer to the sea bed, but you can apply an offset value to the depth data, so that the displayed depth reading represents the depth to the sea bed from either the keel or the waterline.

Before attempting to set a waterline or keel offset, find out the vertical separation between the transducer and either the waterline or the bottom of the keel on your vessel, as appropriate. Then set the appropriate depth offset value.

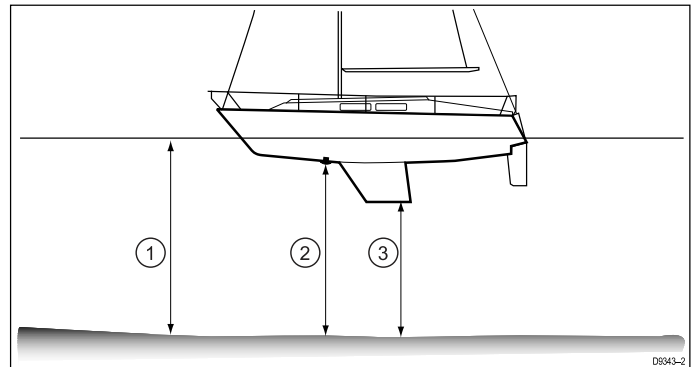

1	Waterline offset
2	Transducer / Zero offset
3	Keel offset

If an offset is not applied, displayed depth readings represent the distance from the transducer to the sea bed.

## Calibrating Bidata

To calibrate your i40 Bidata follow the steps below.

During normal operation:

1. Simultaneously press and hold the **Down** and **Action** buttons for 2 seconds to display the User Calibration page.

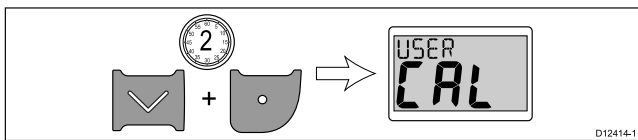

2. Press the **Action** button to display the Depth Response page.

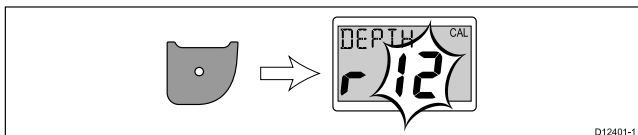

3. Use the **Up** and **Down** buttons to adjust the Depth Response to the required level.  
The default level is 12. The levels available are 1 to 15 with level 1 being the slowest update rate and level 15 the quickest.

4. Press the **Action** button to display the Speed Response page.

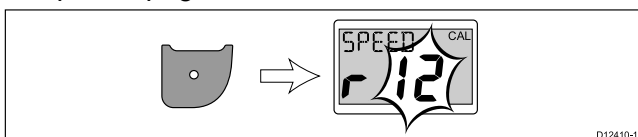

5. Use the **Up** and **Down** buttons to adjust the speed response to the required level.  
The default level is 12. The levels available are 1 to 15 with level 1 being the slowest update rate and level 15 the quickest.

6. Press the **Action** button to display the Depth units page.

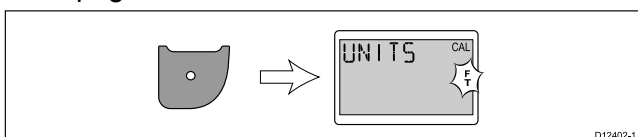

7. Use the **Up** and **Down** buttons to select the required unit of measurement for depth readings.  
The units of measure available for depth readings are:

- FT — feet (default)
- M — Meters
- FA — Fathoms

8. Press the **Action** button to display the Speed units page.

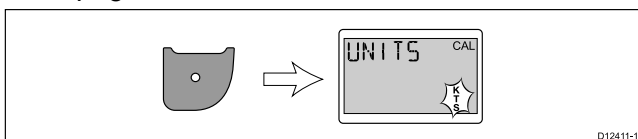

9. Use the **Up** and **Down** buttons to select the required unit of measurement for speed readings.  
The units of measure available for speed readings are:

- KTS — Knots (default)
- MPH — Miles Per Hour

- KPH — Kilometers Per Hour

10. Press the **Action** button to display the Distance units page.

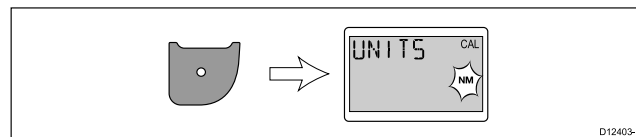

11. Use the **Up** and **Down** buttons to select the required unit of measurement for distance readings.

The units of measure available for distance readings are:

- NM — Nautical Miles (default)
- SM — Statute Miles
- KM — Kilometers

12. Press the **Action** button to display the Water temperature units page.

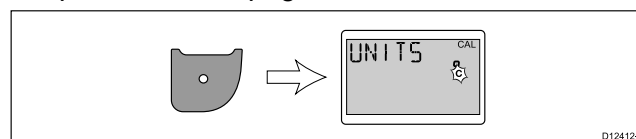

13. Use the **Up** and **Down** buttons to select the required unit of measurement for temperature readings.

The units of measure available for temperature are:

- °C — degrees Celsius (default)
- °F — degrees Fahrenheit

14. Press the **Action** button to display to the Speed Calibration Factor page.

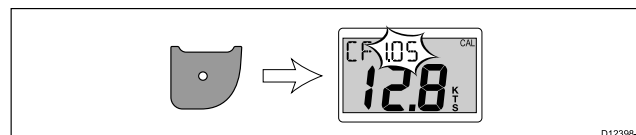

15. Use the **Up** button to increase the calibration factor value, or the **Down** button to decrease the calibration factor value until the displayed speed is correct.

The default calibration factor is 1.00. The calibration factor can be set from 0.25 to 2.50.

16. Alternatively:

- i. Simultaneously press and hold the **Up** and **Down** buttons to display the Speed Over Ground (SOG) page.

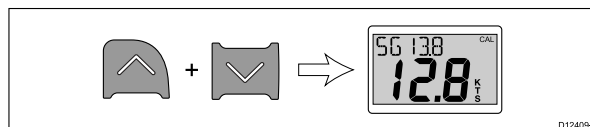

**Note:** The SOG page is only displayed if SOG data is available on SeaTalk and the vessel speed is greater than 0.5 kts.

- ii. Then, in conditions of zero tide and current, press the **Up** button for 3 seconds to apply the SOG value as the speed reading.



17. Press the **Action** button to display the Depth Offset page.

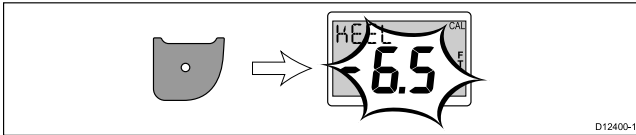

18. Use the **Up** and **Down** buttons to select the required depth offset value.

The depth offset can be set to the following values:

- Keel — values between  $-9.9$  to  $-0.1$
- OFST (zero offset) (default) —  $0.0$
- W/L (Waterline) — values between  $0.1$  to  $9.9$

19. Press the **Action** button to display the Shallow Alarm Lock page.

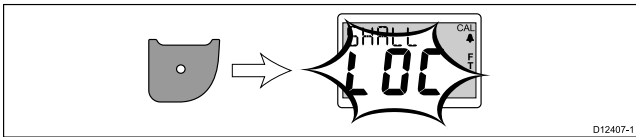

20. Use the **Up** and **Down** buttons to switch the shallow alarm lock on and off.

With the Shallow Alarm Lock On you cannot change the alarm threshold or switch the alarm on and off. To change the alarm threshold or switch the alarm on and off the alarm lock must be set to Off (default).

21. To save your settings and return to normal operation from any page, simultaneously press and hold the **Down** and **Action** buttons for 2 seconds.

## 7.5 Intermediate calibration

Intermediate calibration allows you to:

- Check the instrument software version.
- Check and if necessary set the instrument status as either Master or Repeater.

### Checking software version and instrument status

During normal operation:

1. Simultaneously press and hold the **Down** and **Action** buttons for 4 seconds to display the software version.

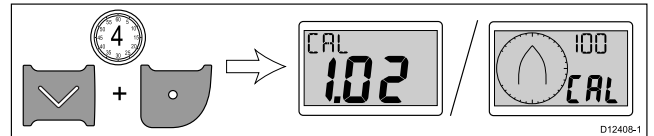

2. Press the **Action** button to display the instrument status.

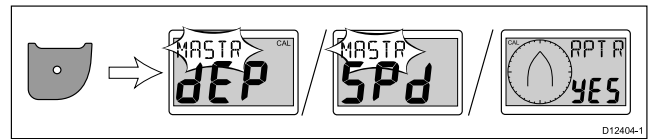

**Note:** The i40 Bidata requires an extra Action button push to switch from depth instrument status and speed instrument status.

3. Use the **Up** and **Down** buttons to change the instrument status between Master and Repeater.
4. To save your settings and return to normal operation from any page, simultaneously press and hold the **Down** and **Action** buttons for 2 seconds.

## 7.6 Dealer calibration

Dealer calibration enables you to set:

- User calibration menu access On (default) and Off.
- Boat show mode On and Off (default) (Boat show mode is only be available on displays set as repeaters).
- Reset to factory defaults.

### Changing dealer calibration settings

1. Simultaneously press and hold the **Down** and **Action** buttons for 12 seconds to display the Dealer Calibration page.



2. Press the **Action** button to display the User Calibration Access page.



3. Use the **Up** and **Down** buttons to switch access to the User Calibration menu On (default) and Off. Selecting Off disables access to the User Calibration menu.
4. Press the **Action** button to display the Boat Show Mode page.

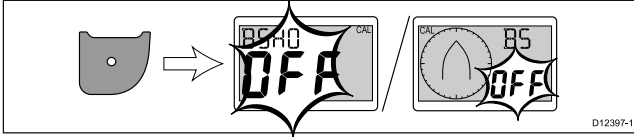

5. Use the **Up** and **Down** buttons to switch boat show mode On and Off. Selecting On will put the display into boat show mode.

**Note:** Boat Show Mode NOT be used whilst your vessel is in use.

6. Press the **Action** button to display the Factory defaults page.



7. To reset the display to factory default settings:
  - i. Use the **Up** or **Down** buttons to change the reset option to Yes.
  - ii. Press the **Action** button to reset your display to factory default settings.

Resetting the unit defaults the display to a repeater display. Refer to [6.3 Data master](#) for details on how to change the display back to a data master, if required.

8. To save your settings and return to normal operation from any page, simultaneously press and hold the **Down** and **Action** buttons for 2 seconds.

## 7.7 Switching the depth and speed position

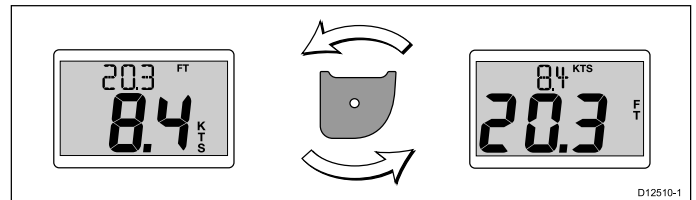

1. Press the **Action** button to switch speed and depth positions on the display.

## 7.8 Using the depth pages

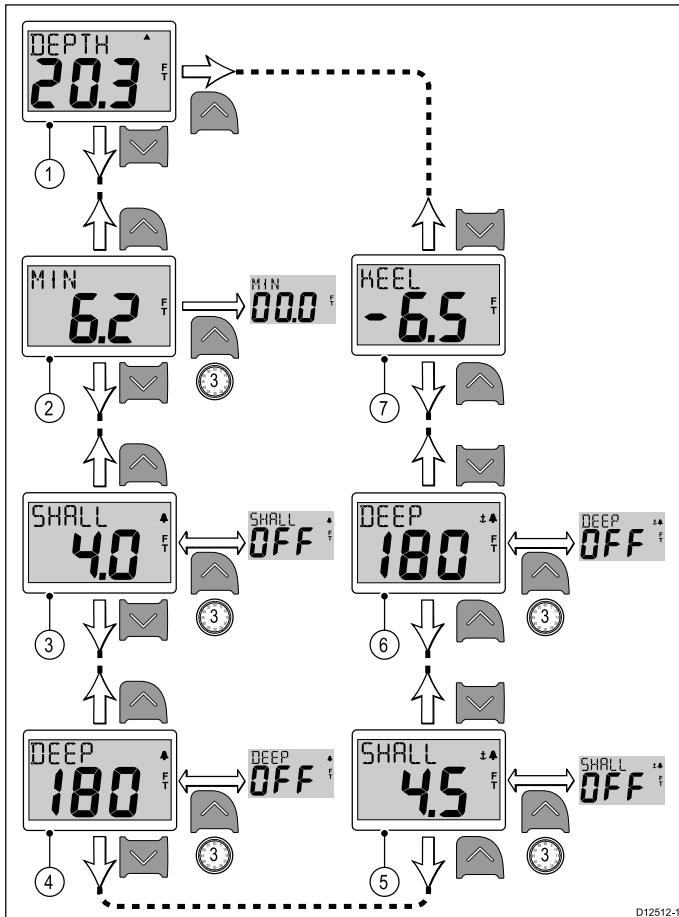

Page order	Page name
1	Current Depth
2	Minimum Depth
3	Shallow Alarm
4	Deep Alarm
5	Shallow Anchor Alarm
6	Deep Anchor Alarm
7	Depth Offset

### Note:

- Alarm and offset pages are only available if the unit's status is set to Master (See the *Data master* section for details).
- Only the **Current Depth** page is a permanent page, all other pages will time out after 5 seconds and revert back to the last permanent page displayed.
- For details on enabling, disabling and adjusting alarm thresholds please refer to [Chapter 11 Alarms](#)

1. Use the **Up** and **Down** buttons to cycle through the available pages.
2. To reset the Minimum Depth value, from the Minimum Depth page press and hold the **Up** button for 3 seconds.
3. To switch alarms On and Off (default), from the relevant alarm page press and hold the **Up** button for 3 seconds.

## 7.9 Using the speed pages

To cycle through the speed pages follow the steps below:

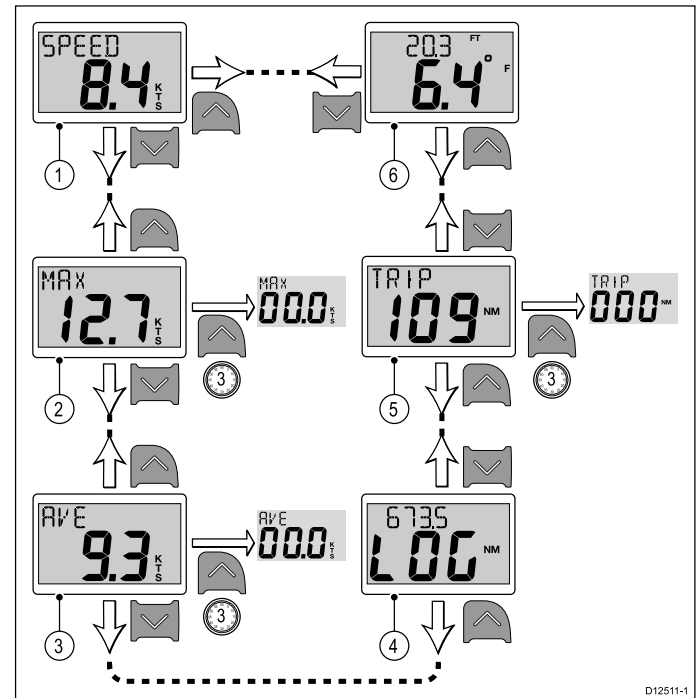

Page order	Page name
1	Current Speed
2	Max Speed
3	Average Speed
4	Log
5	Trip
6	Water Temperature

1. Use the **Up** and **Down** buttons to cycle through the available pages.
2. To reset the Maximum speed, Average speed and Trip values, with the relevant page displayed press and hold the **Up** button for 3 seconds.

**Note:** The trip reading can only be reset if the unit's status is set to Master (See the *Data master* section for details).

**Note:** Only the **Current speed** and **Water temperature** pages are permanent pages, all other pages will time out after 5 seconds and revert back to the last permanent page displayed.



# Chapter 8: i40 Depth

## Chapter contents

- [8.1 i40 Depth operation on page 46](#)
- [8.2 Calibration on page 46](#)
- [8.3 User calibration — i40 Depth on page 47](#)
- [8.4 Intermediate calibration on page 48](#)
- [8.5 Dealer calibration on page 48](#)
- [8.6 Using the depth pages on page 49](#)

## 8.1 i40 Depth operation

When connected to the relevant depth transducer, your i40 depth instrument:

- Provides depth information, in either feet (ft), metres (M) or fathoms (FA).
- Records the minimum depth encountered during the period the unit is switched on.
- Enables you to define alarm thresholds for shallow alarm, deep alarm, shallow anchor alarm and deep anchor alarm.
- Enables you to see what offset has been applied to the depth reading.

**Note:** The required depth units are selected during User calibration.

It should be noted that:

- Up / Down depth-trend arrows are displayed, if the seabed is rising or falling at a significant rate.
- Minimum depth reading is reset to zero at power up.

## 8.2 Calibration

Before first use calibration procedures must be carried out to ensure optimum performance of the instrument with the vessel.

The calibration procedures are:

- User calibration
- Intermediate calibration
- Dealer calibration

## 8.3 User calibration — i40 Depth

Calibration procedures are dependant on instrument display variant.

User calibration options include:

- Depth display response — Dictates the rate at which the instrument display responds to changes in depth data.
- \* Units for depth readings — Assigns the unit of measure used for depth related readings.
- \* Depth offset — Assigns an offset to the depth reading.
- \* Shallow alarm lock — Locks the Shallow alarm.

**Note:** \* These settings are only available on units when the instrument status set to Master (see Intermediate Calibration for details of changing the display to be Master or Repeater).

### Depth Offset

Depths are measured from the transducer to the sea bed, but you can apply an offset value to the depth data, so that the displayed depth reading represents the depth to the sea bed from either the keel or the waterline.

Before attempting to set a waterline or keel offset, find out the vertical separation between the transducer and either the waterline or the bottom of the keel on your vessel, as appropriate. Then set the appropriate depth offset value.

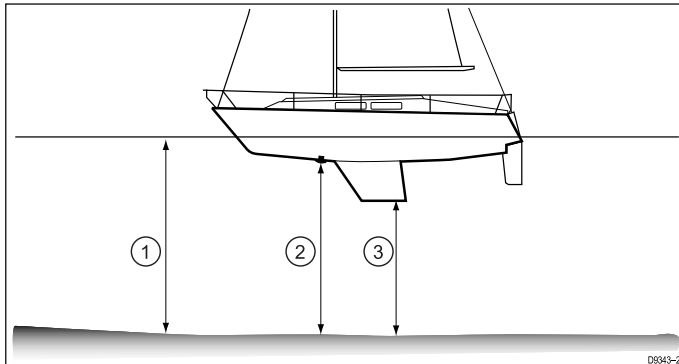

1	Waterline offset
2	Transducer / Zero offset
3	Keel offset

If an offset is not applied, displayed depth readings represent the distance from the transducer to the sea bed.

### Calibrating depth

To calibrate your i40 Depth follow the steps below.

During normal operation:

1. Simultaneously press and hold the **Down** and **Action** buttons for 2 seconds to display the User Calibration page.

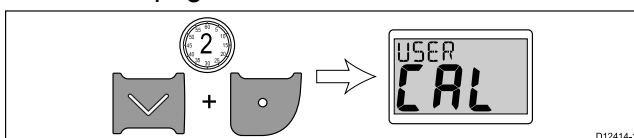

2. Press the **Action** button to display the Depth Response page.

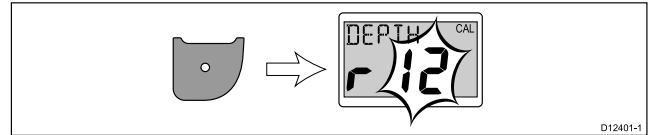

3. Use the **Up** and **Down** buttons to adjust the Depth Response to the required level. The default level is 12. The levels available are 1 to 15 with level 1 being the slowest update rate and level 15 the quickest.
4. Press the **Action** button to display the Depth units page.

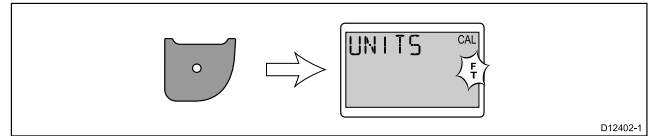

5. Use the **Up** and **Down** buttons to select the required unit of measurement for depth readings. The units of measure available for depth readings are:
  - FT — feet (default)
  - M — Meters
  - FA — Fathoms

6. Press the **Action** button to display the Depth Offset page.

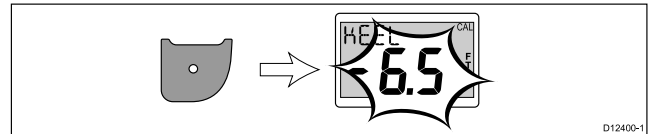

7. Use the **Up** and **Down** buttons to select the required depth offset value. The depth offset can be set to the following values:
  - Keel — values between  $-9.9$  to  $-0.1$
  - OFST (zero offset) (default) —  $0.0$
  - W/L (Waterline) — values between  $0.1$  to  $9.9$

8. Press the **Action** button to display the Shallow Alarm Lock page.

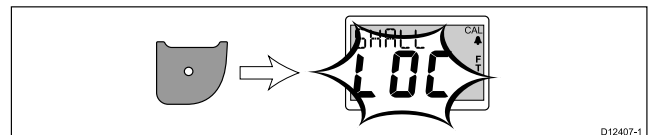

9. Use the **Up** and **Down** buttons to switch the shallow alarm lock on and off. With the Shallow Alarm Lock On you cannot change the alarm threshold or switch the alarm on and off. To change the alarm threshold or switch the alarm on and off the alarm lock must be set to Off (default).
10. To save your settings and return to normal operation from any page, simultaneously press and hold the **Down** and **Action** buttons for 2 seconds.

## 8.4 Intermediate calibration

Intermediate calibration allows you to:

- Check the instrument software version.
- Check and if necessary set the instrument status as either Master or Repeater.

### Checking software version and instrument status

During normal operation:

1. Simultaneously press and hold the **Down** and **Action** buttons for 4 seconds to display the software version.

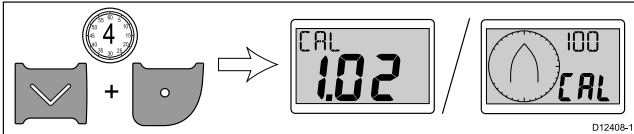

2. Press the **Action** button to display the instrument status.

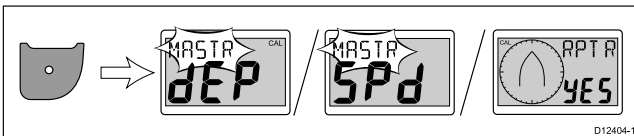

**Note:** The i40 Bidata requires an extra Action button push to switch from depth instrument status and speed instrument status.

3. Use the **Up** and **Down** buttons to change the instrument status between Master and Repeater.
4. To save your settings and return to normal operation from any page, simultaneously press and hold the **Down** and **Action** buttons for 2 seconds.

## 8.5 Dealer calibration

Dealer calibration enables you to set:

- User calibration menu access On (default) and Off.
- Boat show mode On and Off (default) (Boat show mode is only be available on displays set as repeaters).
- Reset to factory defaults.

### Changing dealer calibration settings

1. Simultaneously press and hold the **Down** and **Action** buttons for 12 seconds to display the Dealer Calibration page.



2. Press the **Action** button to display the User Calibration Access page.



3. Use the **Up** and **Down** buttons to switch access to the User Calibration menu On (default) and Off. Selecting Off disables access to the User Calibration menu.
4. Press the **Action** button to display the Boat Show Mode page.

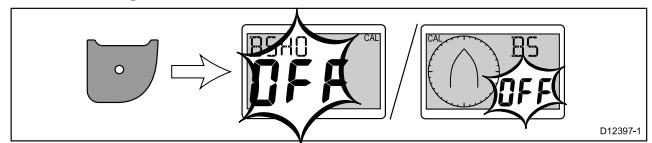

5. Use the **Up** and **Down** buttons to switch boat show mode On and Off. Selecting On will put the display into boat show mode.

**Note:** Boat Show Mode NOT be used whilst your vessel is in use.

6. Press the **Action** button to display the Factory defaults page.



7. To reset the display to factory default settings:
  - i. Use the **Up** or **Down** buttons to change the reset option to Yes.
  - ii. Press the **Action** button to reset your display to factory default settings.

Resetting the unit defaults the display to a repeater display. Refer to [6.3 Data master](#) for details on how to change the display back to a data master, if required.

8. To save your settings and return to normal operation from any page, simultaneously press and hold the **Down** and **Action** buttons for 2 seconds.



## 8.6 Using the depth pages

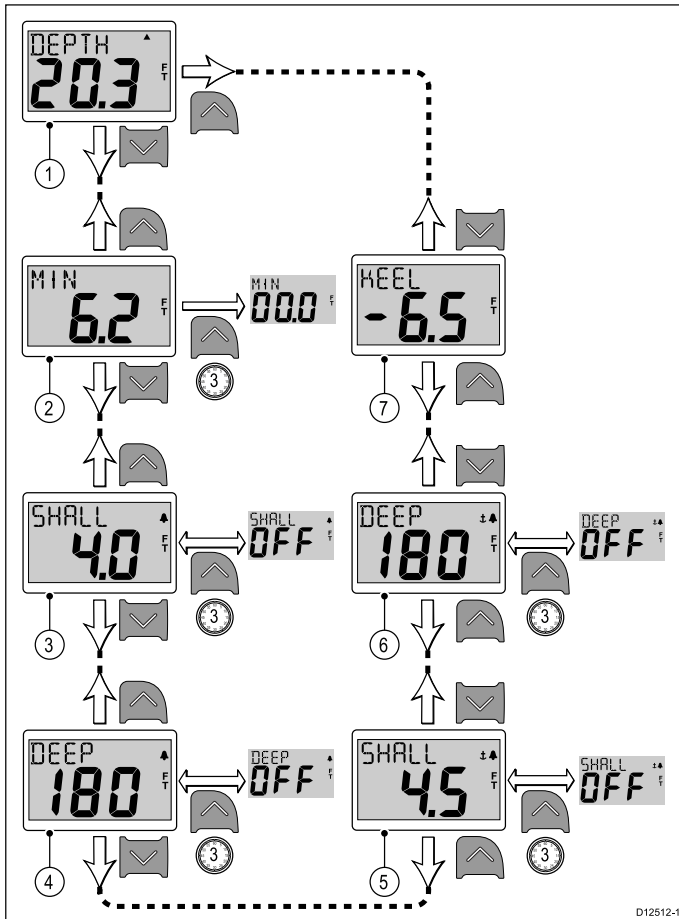

D12512-1

Page order	Page name
1	Current Depth
2	Minimum Depth
3	Shallow Alarm
4	Deep Alarm
5	Shallow Anchor Alarm
6	Deep Anchor Alarm
7	Depth Offset

### Note:

- Alarm and offset pages are only available if the unit's status is set to Master (See the *Data master* section for details).
- Only the **Current Depth** page is a permanent page, all other pages will time out after 5 seconds and revert back to the last permanent page displayed.
- For details on enabling, disabling and adjusting alarm thresholds please refer to [Chapter 11 Alarms](#)

1. Use the **Up** and **Down** buttons to cycle through the available pages.
2. To reset the Minimum Depth value, from the Minimum Depth page press and hold the **Up** button for 3 seconds.
3. To switch alarms On and Off (default), from the relevant alarm page press and hold the **Up** button for 3 seconds.



# Chapter 9: i40 Speed

## Chapter contents

- [9.1 i40 Speed operation on page 52](#)
- [9.2 Calibration on page 52](#)
- [9.3 User calibration — i40 Speed on page 53](#)
- [9.4 Intermediate calibration on page 54](#)
- [9.5 Dealer calibration on page 54](#)
- [9.6 Using the speed pages on page 55](#)

## 9.1 i40 Speed operation

When connected to the relevant speed or speed and temperature transducer, your i40 Speed instrument provides:

- Current, maximum and average speed information, in either knots (KTS), mile per hour (MPH) or kilometers per hour (KPH).
- Log and trip information, in either nautical miles (NM), statute miles (M) or kilometers (KM).
- Water temperature information, in either degrees celsius (°C) or fahrenheit (°F).

**Note:** The required speed, distance and temperature units are selected during User calibration.

It should be noted that:

- The maximum speed, average speed and trip reading are reset to zero at power up.
- The log screen shows the total distance covered by the vessel since the unit was fitted.

## 9.2 Calibration

Before first use calibration procedures must be carried out to ensure optimum performance of the instrument with the vessel.

The calibration procedures are:

- User calibration
- Intermediate calibration
- Dealer calibration

## 9.3 User calibration — i40 Speed

Calibration procedures are dependant on instrument display variant.

User calibration options include:

- Speed display response — Dictates the rate at which the instrument display responds to changes in speed data.
- \* Units for speed readings — Assigns the unit of measure used for speed related readings.
- \* Units for distance readings — Assigns the unit of measure used for distance related readings.
- \* Units for water temperature — Assigns the unit of measure used for temperature related readings.
- \* Correct speed reading — Assigns an offset to the speed reading.

**Note:** \* These settings are only available on units when the instrument status set to Master (see Intermediate Calibration for details of changing the display to be Master or Repeater).

### Calibrating speed

To calibrate your i40 Speed follow the steps below.

During normal operation:

1. Simultaneously press and hold the **Down** and **Action** buttons for 2 seconds to display the User Calibration page.

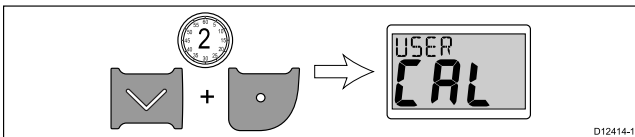

2. Press the **Action** button to display the Speed Response page.

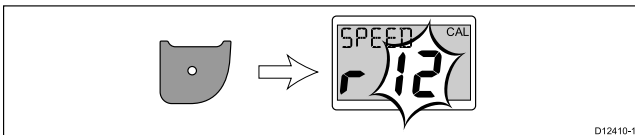

3. Use the **Up** and **Down** buttons to adjust the speed response to the required level. The default level is 12. The levels available are 1 to 15 with level 1 being the slowest update rate and level 15 the quickest.

4. Press the **Action** button to display the Speed units page.

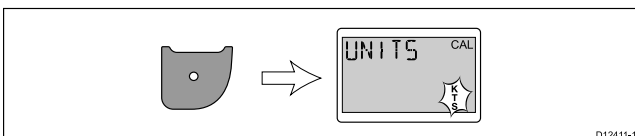

5. Use the **Up** and **Down** buttons to select the required unit of measurement for speed readings.

The units of measure available for speed readings are:

- KTS — Knots (default)
- MPH — Miles Per Hour
- KPH — Kilometers Per Hour

6. Press the **Action** button to display the Distance units page.

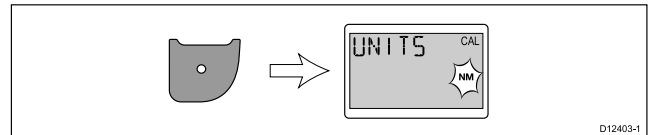

7. Use the **Up** and **Down** buttons to select the required unit of measurement for distance readings.

The units of measure available for distance readings are:

- NM — Nautical Miles (default)
- SM — Statute Miles
- KM — Kilometers

8. Press the **Action** button to display the Water temperature units page.

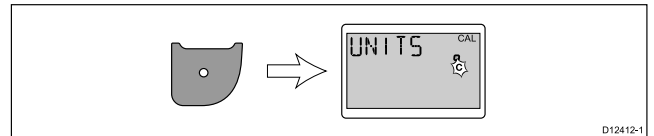

9. Use the **Up** and **Down** buttons to select the required unit of measurement for temperature readings.

The units of measure available for temperature are:

- °C — degrees Celsius (default)
- °F — degrees Fahrenheit

10. Press the **Action** button to display to the Speed Calibration Factor page.

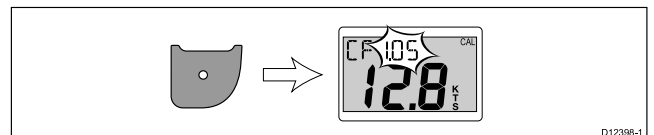

11. Use the **Up** button to increase the calibration factor value, or the **Down** button to decrease the calibration factor value until the displayed speed is correct.

The default calibration factor is 1.00. The calibration factor can be set from 0.25 to 2.50.

12. Alternatively:

- i. Simultaneously press and hold the **Up** and **Down** buttons to display the Speed Over Ground (SOG) page.

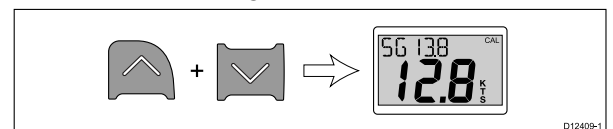

**Note:** The SOG page is only displayed if SOG data is available on SeaTalk and the vessel speed is greater than 0.5 kts.

- ii. Then, in conditions of zero tide and current, press the **Up** button for 3 seconds to apply the SOG value as the speed reading.

13. To save your settings and return to normal operation from any page, simultaneously press and hold the **Down** and **Action** buttons for 2 seconds.

## 9.4 Intermediate calibration

Intermediate calibration allows you to:

- Check the instrument software version.
- Check and if necessary set the instrument status as either Master or Repeater.

### Checking software version and instrument status

During normal operation:

1. Simultaneously press and hold the **Down** and **Action** buttons for 4 seconds to display the software version.

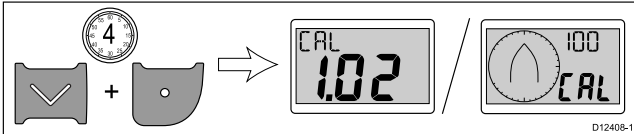

2. Press the **Action** button to display the instrument status.

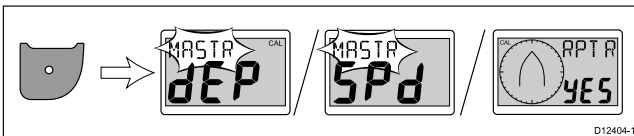

**Note:** The i40 Bidata requires an extra Action button push to switch from depth instrument status and speed instrument status.

3. Use the **Up** and **Down** buttons to change the instrument status between Master and Repeater.
4. To save your settings and return to normal operation from any page, simultaneously press and hold the **Down** and **Action** buttons for 2 seconds.

## 9.5 Dealer calibration

Dealer calibration enables you to set:

- User calibration menu access On (default) and Off.
- Boat show mode On and Off (default) (Boat show mode is only be available on displays set as repeaters).
- Reset to factory defaults.

### Changing dealer calibration settings

1. Simultaneously press and hold the **Down** and **Action** buttons for 12 seconds to display the Dealer Calibration page.



2. Press the **Action** button to display the User Calibration Access page.



3. Use the **Up** and **Down** buttons to switch access to the User Calibration menu On (default) and Off. Selecting Off disables access to the User Calibration menu.
4. Press the **Action** button to display the Boat Show Mode page.

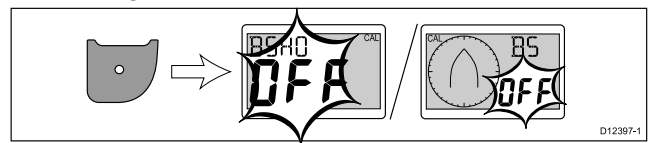

5. Use the **Up** and **Down** buttons to switch boat show mode On and Off. Selecting On will put the display into boat show mode.

**Note:** Boat Show Mode NOT be used whilst your vessel is in use.

6. Press the **Action** button to display the Factory defaults page.



7. To reset the display to factory default settings:
  - i. Use the **Up** or **Down** buttons to change the reset option to Yes.
  - ii. Press the **Action** button to reset your display to factory default settings.

Resetting the unit defaults the display to a repeater display. Refer to [6.3 Data master](#) for details on how to change the display back to a data master, if required.

8. To save your settings and return to normal operation from any page, simultaneously press and hold the **Down** and **Action** buttons for 2 seconds.

## 9.6 Using the speed pages

To cycle through the speed pages follow the steps below:

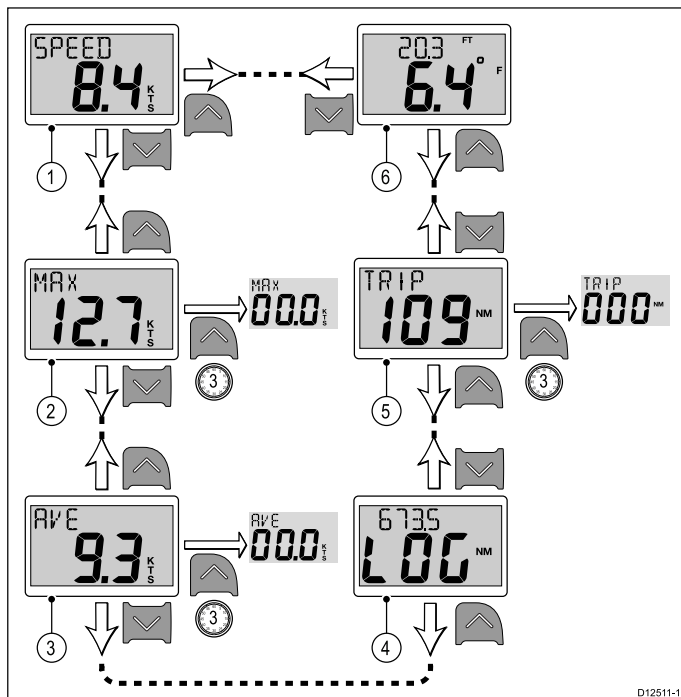

Page order	Page name
1	Current Speed
2	Max Speed
3	Average Speed
4	Log
5	Trip
6	Water Temperature

1. Use the **Up** and **Down** buttons to cycle through the available pages.
2. To reset the Maximum speed, Average speed and Trip values, with the relevant page displayed press and hold the **Up** button for 3 seconds.

**Note:** The trip reading can only be reset if the unit's status is set to Master (See the *Data master* section for details).

**Note:** Only the **Current speed** and **Water temperature** pages are permanent pages, all other pages will time out after 5 seconds and revert back to the last permanent page displayed.





# Chapter 10: i40 Wind

## Chapter contents

- [10.1 i40 Wind operation on page 58](#)
- [10.2 Calibration on page 58](#)
- [10.3 User calibration — i40 Wind on page 59](#)
- [10.4 Intermediate calibration on page 60](#)
- [10.5 Dealer calibration on page 60](#)
- [10.6 True and apparent wind pages on page 61](#)
- [10.7 Using the wind pages on page 61](#)

## 10.1 i40 Wind operation

When connected to a rotavecta transducer, your i40 Wind instrument:

- Provides apparent wind speed and direction information, in either knots (KTS), or metres per second (M/S).
- Provides true wind speed and direction information, if vessel speed information is available on SeaTalk.
- Enables a locked apparent wind angle, which is defined either manually or automatically by a course computer. In this mode, the unit shows the deviations from the locked wind angle and the direction to steer to achieve the locked wind angle.

## 10.2 Calibration

Before first use calibration procedures must be carried out to ensure optimum performance of the instrument with the vessel.

The calibration procedures are:

- User calibration
- Intermediate calibration
- Dealer calibration

## 10.3 User calibration — i40 Wind

Calibration procedures are dependant on instrument display variant.

User calibration options include:

- Wind Angle display response — Dictates the rate at which the instrument display responds to changes in wind angle data.
- Wind Speed display response — Dictates the rate at which the instrument display responds to changes in wind speed data.
- “ Units for wind speed readings — Assigns the unit of measure used for wind speed related readings.
- Linearization — Performs wind transducer linearization.
- Alignment — Aligns wind transducer to vessel heading.

**Note:** \* These settings are only available on units when the instrument status set to Master (see Intermediate Calibration for details of changing the display to be Master or Repeater).

### Calibrating wind

You will need to be underway, with sufficient space to turn in a large slow circle unhindered. Conditions should be calm (i.e. a slight sea) and a steady breeze. Try to ensure the vessel is not rolling or pitching too much.

During normal operation:

1. Simultaneously press and hold the **Down** and **Action** buttons for 2 seconds to display the User Calibration page.

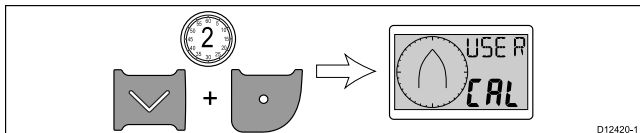

2. Press the **Action** button to display the set Wind Angle Response page.

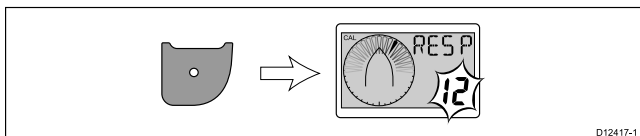

3. Use the **Up** and **Down** buttons to adjust the wind angle response to the required level.

The default level is 12. The levels available are 1 to 15 with level 1 being the slowest update rate and level 15 the quickest.

4. Press the **Action** button to display the Wind Speed Response page.

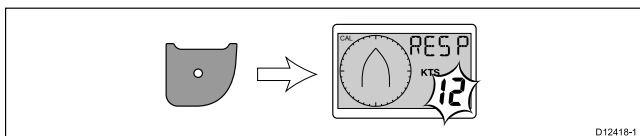

5. Use the **Up** and **Down** buttons to adjust the wind speed response to the required level.

The default level is 12. The levels available are 1 to 15 with level 1 being the slowest update rate and level 15 the quickest.

6. Press the **Action** button to display the Wind Speed Units page.

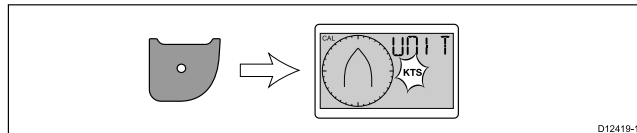

7. Use the **Up** and **Down** buttons to select the required unit of measurement for wind speed readings.

The units of measure available for wind speed readings are:

- KTS — Knots (default)
- M/S — Meters Per Second

8. Press the **Action** button to display the Linearize Transducer page.

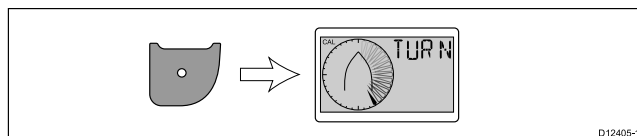

**Note:** If 5pd is displayed on the linearize transducer page the wind speed is outside of the range suitable for linearization.

9. Keep the vessel speed below 2 kts and begin to turn the vessel in a circle.
10. Press the **Up** button to begin linearization.
11. You will be required to perform a minimum of 2 complete circles.

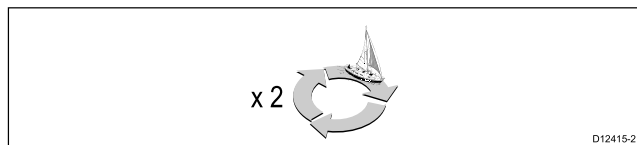

An alarm will sound upon successful completion.

12. Sail the vessel directly into the wind.
13. Press the **Action** button to display the Align Transducer page.

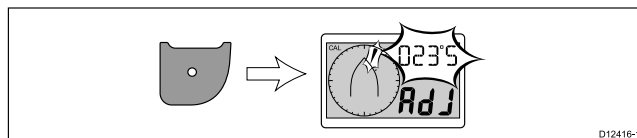

14. Use the **Up** and **Down** buttons to adjust the value until the wind angle pointer is set to zero.

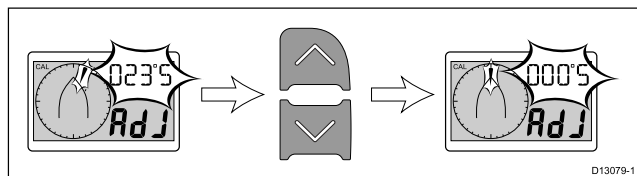

15. To save your settings and return to normal operation from any page, simultaneously press and hold the **Down** and **Action** buttons for 2 seconds.

## 10.4 Intermediate calibration

Intermediate calibration allows you to:

- Check the instrument software version.
- Check and if necessary set the instrument status as either Master or Repeater.

### Checking software version and instrument status

During normal operation:

1. Simultaneously press and hold the **Down** and **Action** buttons for 4 seconds to display the software version.

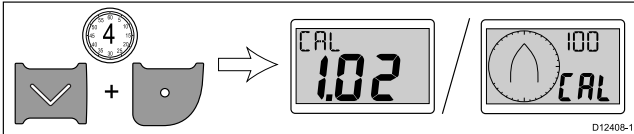

2. Press the **Action** button to display the instrument status.

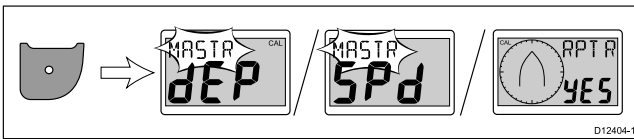

**Note:** The i40 Bidata requires an extra Action button push to switch from depth instrument status and speed instrument status.

3. Use the **Up** and **Down** buttons to change the instrument status between Master and Repeater.
4. To save your settings and return to normal operation from any page, simultaneously press and hold the **Down** and **Action** buttons for 2 seconds.

## 10.5 Dealer calibration

Dealer calibration enables you to set:

- User calibration menu access On (default) and Off.
- Boat show mode On and Off (default) (Boat show mode is only be available on displays set as repeaters).
- Reset to factory defaults.

### Changing dealer calibration settings

1. Simultaneously press and hold the **Down** and **Action** buttons for 12 seconds to display the Dealer Calibration page.



2. Press the **Action** button to display the User Calibration Access page.



3. Use the **Up** and **Down** buttons to switch access to the User Calibration menu On (default) and Off. Selecting Off disables access to the User Calibration menu.
4. Press the **Action** button to display the Boat Show Mode page.

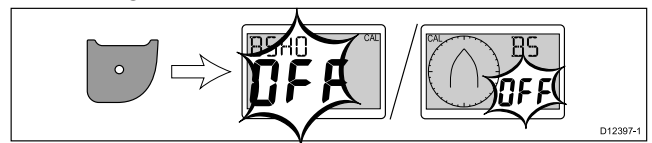

5. Use the **Up** and **Down** buttons to switch boat show mode On and Off. Selecting On will put the display into boat show mode.

**Note:** Boat Show Mode NOT be used whilst your vessel is in use.

6. Press the **Action** button to display the Factory defaults page.



7. To reset the display to factory default settings:
  - i. Use the **Up** or **Down** buttons to change the reset option to Yes.
  - ii. Press the **Action** button to reset your display to factory default settings.

Resetting the unit defaults the display to a repeater display. Refer to [6.3 Data master](#) for details on how to change the display back to a data master, if required.

8. To save your settings and return to normal operation from any page, simultaneously press and hold the **Down** and **Action** buttons for 2 seconds.

## 10.6 True and apparent wind pages

### Apparent and True wind pages

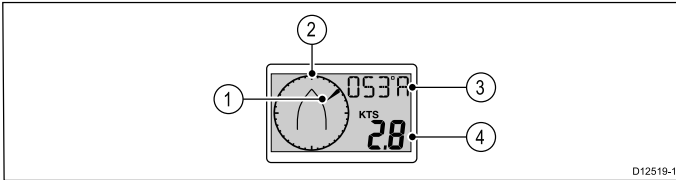

1. Wind direction with respect to vessel heading.
2. Vessel heading.
3. Wind angle, either A (apparent) or T (True).
4. Wind speed, either apparent or true, as indicated in item 3.

### Locked apparent wind page

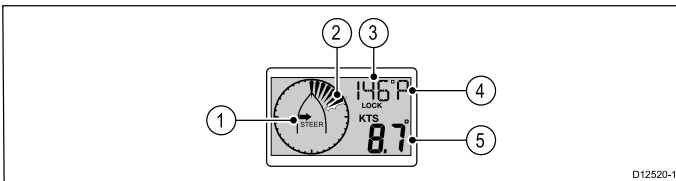

1. Direction to steer indicator, to achieve locked wind angle.
2. Flashing segment indicates the difference between the apparent wind angle and the locked wind angle.
3. Locked wind angle.
4. Relative direction of the locked wind angle:
  - **P** = Port.
  - **S** = Starboard.
5. Apparent wind speed.

**Note:** If **LOCK** is displayed on-screen then the wind angle is controlled by the course computer and cannot be changed manually.

## 10.7 Using the wind pages

To cycle through the wind pages follow the steps below:

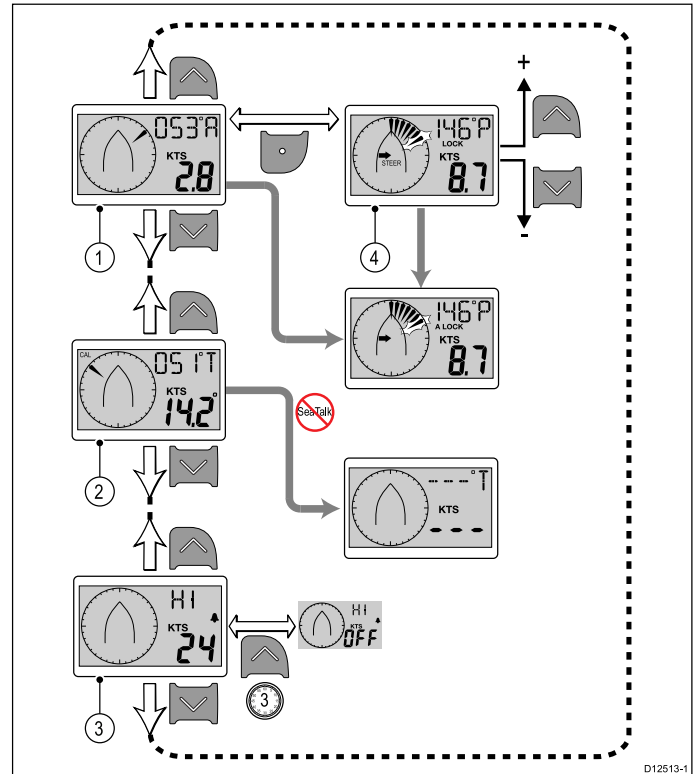

1	Apparent Wind.
2	True Wind.
3	High Speed Wind Alarm
4	Locked Apparent Wind

**Note:** The **High wind speed alarm** page is only available on master units (See the *Data master* section for details), it is a temporary page which will time out after 5 seconds to the previous permanent page.

1. Use the **Up** and **Down** buttons to cycle through the available pages.
2. Pressing the **Action** button from the Apparent Wind page will apply the current wind bearing as the locked heading and display the Locked Apparent Wind Angle page.
3. Pressing the **Action** button from the Locked Apparent Wind page will return to the Apparent Wind page.
4. Pressing and holding the **Up** button from the High Wind Speed Alarm page will switch the High Wind Speed Alarm On (default) and Off.

**Note:** For details on enabling, disabling and adjusting alarm thresholds please refer to [Chapter 11 Alarms](#).



# Chapter 11: Alarms

## Chapter contents

- [11.1 Alarms on page 64](#)

## 11.1 Alarms

Alarms alert you to a situation or hazard requiring your attention.

You can set up alarms to alert you to certain conditions.

Alarms are raised by system functions, and also external equipment connected to your display.

When an alarm event occurs an audible and visual alarm is activated which indicates the alarm state.

Alarm thresholds can be configured from the relevant alarm page / menu.

### Instrument alarms

The alarms available on each instrument display variant are shown below.

- **Shallow Alarm** — Available on i40 Bidata and i40 Depth instrument displays.
- **Deep Alarm** — Available on i40 Bidata and i40 Depth instrument displays.
- **Shallow Anchor Alarm** — Available on the i40 Bidata and i40 Depth instrument displays.
- **Deep Anchor Alarm** — Available on the i40 Bidata and i40 Depth instrument displays.
- **High Wind speed Alarm** — Available on the i40 Wind instrument displays.

### Alarm indications

An alarm event is indicated by both audible and visual warnings.

#### Shallow alarm

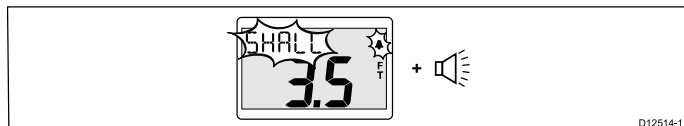

The Shallow alarm is available on both the i40 Bidata and i40 Depth instruments. The Shallow alarm sounds when the depth is equal to or less than the Shallow alarm threshold. The alarm sounds until silenced manually.

#### Deep alarm



The Deep alarm is available on both the i40 Bidata and i40 Depth instruments. The Deep alarm sounds when the depth is equal to the Deep alarm threshold. The alarm sounds until silenced manually.

#### Anchor alarms

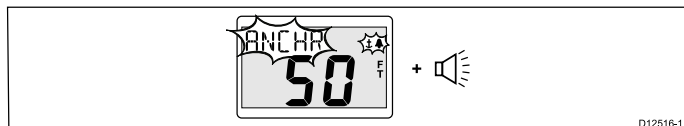

The anchor alarms are available on both the i40 Bidata and i40 Depth instruments. The anchor alarms sound when either:

- Depth is equal to or less than the Shallow anchor alarm threshold, or
- Depth is equal to or more than the Deep anchor alarm threshold.

The alarm sounds until silenced manually.

### High wind speed alarm

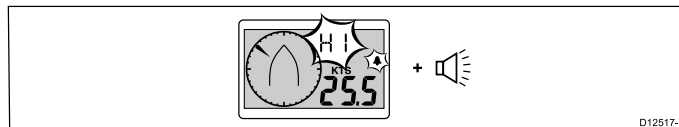

The High wind speed alarm is available on the i40 Wind instrument. The High wind speed alarm sounds when the wind speed exceeds the High wind speed alarm threshold. The alarm sounds until silenced manually.

**True wind** — If vessel speed information is available at the instrument (from a SeaTalk bus) the alarm is triggered if True wind speed exceeds the threshold.

**Apparent wind** — If vessel speed information is not present, the alarm is triggered if the Apparent wind speed exceeds the threshold.

### Silencing alarms

1. Press any button to silence an active alarm.

### Enabling / Disabling alarms

Alarms can be enabled or disabled at any time.

With the relevant alarm page displayed:

1. Press and hold the **Up** button for 3 seconds to switch the alarm on or off.

### Setting alarm thresholds

You can adjust the threshold at which alarms are triggered by following the steps below.

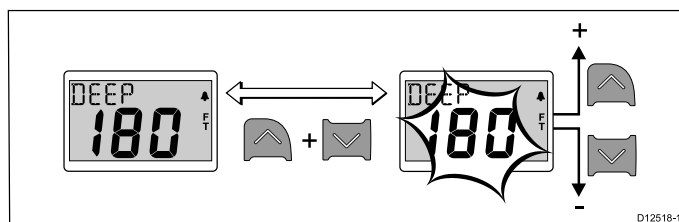

With the relevant alarm page displayed:

1. Press the **Up** and **Down** button simultaneously to enter edit mode.
2. Use the **Up** button to increase the alarm threshold.
3. Use the **Down** button to decrease the alarm threshold.
4. Press the **Up** and **Down** button simultaneously to save the new alarm threshold and exit edit mode.

**Note:** The illustration above is an example depicting setting the Deep alarm threshold on an i40 Depth instrument.



# Chapter 12: Maintaining your display

## Chapter contents

- 12.1 Service and maintenance on page 66
- 12.2 Condensation on page 66
- 12.3 Routine equipment checks on page 67
- 12.4 Cleaning on page 67
- 12.5 Cleaning the display case on page 68
- 12.6 Cleaning the display screen on page 68

## **12.1 Service and maintenance**

This product contains no user serviceable components. Please refer all maintenance and repair to authorized Raymarine dealers. Unauthorized repair may affect your warranty.

## **12.2 Condensation**

Certain atmospheric conditions may cause a small amount of condensation to form on the unit's window. This will not damage the unit and will clear after the unit has been switched on for a short period.

## 12.3 Routine equipment checks

Raymarine strongly recommends that you complete a number of routine checks to ensure the correct and reliable operation of your equipment.

Complete the following checks on a regular basis:

- Examine all cables for signs of damage or wear and tear.
- Check that all cables are securely connected.

## 12.4 Cleaning

Best cleaning practices.

When cleaning this product:

- Do NOT wipe the display screen with a dry cloth, as this could scratch the screen coating.
- Do NOT use abrasive, or acid or ammonia based products.
- Do NOT use a jet wash.

## 12.5 Cleaning the display case

The display unit is a sealed unit and does not require regular cleaning. If it is necessary to clean the unit, follow this basic procedure:

1. Switch off the power to the display.
2. Wipe the display with a clean, soft cloth (a microfibre cloth is ideal).
3. If necessary, use a mild detergent to remove grease marks.

**Note:** Do NOT use solvents or detergents on the screen itself.

**Note:** In certain conditions, condensation may appear inside the display screen. This will not harm the unit, and can be cleared by powering on the display for a short time.

## 12.6 Cleaning the display screen

A coating is applied to the display screen. This makes it water repellent, and prevents glare. To avoid damaging this coating, follow this procedure:

1. Switch off the power to the display.
2. Rinse the screen with fresh water to remove all dirt particles and salt deposits.
3. Allow the screen to dry naturally.
4. If any smears remain, very gently wipe the screen with a clean microfibre cleaning cloth (available from an opticians).

# Chapter 13: Troubleshooting

## Chapter contents

- [13.1 Troubleshooting on page 70](#)
- [13.2 Instrument troubleshooting on page 71](#)
- [13.3 Power up troubleshooting on page 73](#)
- [13.4 Miscellaneous troubleshooting on page 74](#)



## 13.1 Troubleshooting

The troubleshooting information provides possible causes and corrective action required for common problems associated with marine electronics installations.

All Raymarine products are, prior to packing and shipping, subjected to comprehensive test and quality assurance programs. However, if you experience problems with the operation of your product this section will help you to diagnose and correct problems in order to restore normal operation.

If after referring to this section you are still having problems with your unit, please contact Raymarine Technical Support for further advice.

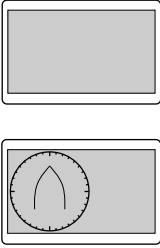
## 13.2 Instrument troubleshooting

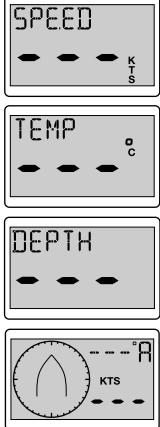
Problem	Applies to	Example screenshots	Action
Low battery.	<ul style="list-style-type: none"> <li>• i40 Bidata</li> <li>• i40 Depth</li> <li>• i40 Speed</li> <li>• i40 Wind</li> </ul>	 <p>D12521-1</p>	<ul style="list-style-type: none"> <li>• Recharge your vessel's battery as soon as possible.</li> </ul>
Blank display.	<ul style="list-style-type: none"> <li>• i40 Bidata</li> <li>• i40 Depth</li> <li>• i40 Speed</li> <li>• i40 Wind</li> </ul>	 <p>D12522-1</p>	<ul style="list-style-type: none"> <li>• Check fuse / circuit breaker.</li> <li>• Check power supply.</li> <li>• Check SeaTalk cabling and connector security.</li> </ul>
Depth reading flashes when underway.	<ul style="list-style-type: none"> <li>• i40 Bidata</li> <li>• i40 Depth</li> </ul>	 <p>D12523-1</p>	<ul style="list-style-type: none"> <li>• Ensure the reading stabilizes when clear of disturbed water (e.g. vessel wakes, propeller wash etc.).</li> </ul>
No data.	<ul style="list-style-type: none"> <li>• i40 Bidata</li> <li>• i40 Depth</li> <li>• i40 Speed</li> <li>• i40 Wind</li> </ul>	 <p>D12524-1</p>	<ul style="list-style-type: none"> <li>• Check the condition of the transducer cable and security of the connections.</li> <li>• Check condition of transducer face and remove any debris.</li> <li>• For i40 wind — if true wind speed information is missing but apparent wind is present then this could be due to no speed information via SeaTalk.</li> </ul>

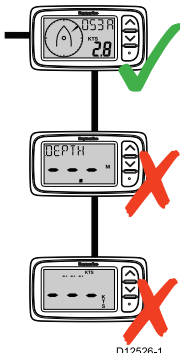
Problem	Applies to	Example screenshots	Action
No speed information but water temperature is present.	<ul style="list-style-type: none"> <li>• i40 Bidata</li> <li>• i40 Speed</li> </ul>		<ul style="list-style-type: none"> <li>• Transducer paddle wheel may be fouled.</li> </ul> <p>If you need to remove the transducer insert, have the transducer bung to hand and secure it in the transducer body immediately after the insert is removed, to prevent excessive ingress of water.</p>
SeaTalk information not being transferred between instruments.	<ul style="list-style-type: none"> <li>• i40 Bidata</li> <li>• i40 Depth</li> <li>• i40 Speed</li> <li>• i40 Wind</li> </ul>	<p>For example, backlighting level changes implemented at one unit do not affect other units.</p>	<ul style="list-style-type: none"> <li>• Check security of SeaTalk connections between units.</li> <li>• Check condition of SeaTalk cables.</li> <li>• Isolate faulty unit by disconnecting units one by one.</li> </ul>
A group of SeaTalk units not working.	<ul style="list-style-type: none"> <li>• i40 Bidata</li> <li>• i40 Depth</li> <li>• i40 Speed</li> <li>• i40 Wind</li> </ul>		<ul style="list-style-type: none"> <li>• Check the security of SeaTalk connectors between functioning and non-functioning units.</li> <li>• Check the condition of SeaTalk cable between functioning and non-functioning units.</li> </ul>



### 13.3 Power up troubleshooting

Problems at power up and their possible causes and solutions are described here.

Problem	Possible causes	Possible solutions
The system (or part of it) does not start up.	Power supply problem.	Check relevant fuses and breakers.
		Check that the power supply cable is sound and that all connections are tight and free from corrosion.
		Check that the power source is of the correct voltage and sufficient current.

## 13.4 Miscellaneous troubleshooting

Miscellaneous problems and their possible causes and solutions are described here.

Problem	Possible causes	Possible solutions
Display behaves erratically: <ul style="list-style-type: none"> <li>• Frequent unexpected resets.</li> <li>• System crashes or other erratic behavior.</li> </ul>	Intermittent problem with power to the display.	Check relevant fuses and breakers.
		Check that the power supply cable is sound and that all connections are tight and free from corrosion.
		Check that the power source is of the correct voltage and sufficient current.
	Software mismatch on system (upgrade required).	Go to <a href="http://www.raymarine.com">www.raymarine.com</a> and click on support for the latest software downloads.
	Corrupt data / other unknown issue.	Perform a factory reset. <div style="border: 1px solid black; padding: 5px; margin-top: 5px;"> <p><b>Important:</b> This will result in the loss of any settings and data (such as waypoints) stored on the product. Save any important data to a memory card before resetting.</p> </div>

## Chapter 14: Technical support

### Chapter contents

- [14.1 Raymarine customer support on page 76](#)

## 14.1 Raymarine customer support

Raymarine provides a comprehensive customer support service. You can contact customer support through the Raymarine website, telephone and e-mail. If you are unable to resolve a problem, please use any of these facilities to obtain additional help.

### Web support

Please visit the customer support area of our website at:

[www.raymarine.com](http://www.raymarine.com)

This contains Frequently Asked Questions, servicing information, e-mail access to the Raymarine Technical Support Department and details of worldwide Raymarine agents.

### Telephone and e-mail support

#### In the USA:

- **Tel:** +1 603 324 7900
- **Toll Free:** +1 800 539 5539
- **E-mail:** [support@raymarine.com](mailto:support@raymarine.com)

#### In the UK, Europe, and the Middle East:

- **Tel:** +44 (0)13 2924 6777
- **E-mail:** [ukproduct.support@raymarine.com](mailto:ukproduct.support@raymarine.com)

#### In Southeast Asia and Australia:

- **Tel:** +61 (0)29479 4800
- **E-mail:** [aus.support@raymarine.com](mailto:aus.support@raymarine.com)

### Product information

If you need to request service, please have the following information to hand:

- Product name.
- Product identity.
- Serial number.
- Software application version.
- System diagrams.

You can obtain this product information using the menus within your product.

### Checking software version and instrument status

During normal operation:

1. Simultaneously press and hold the **Down** and **Action** buttons for 4 seconds to display the software version.

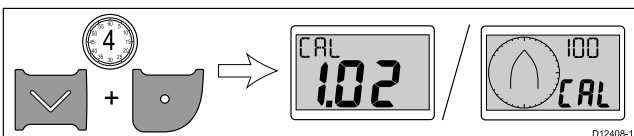

2. Press the **Action** button to display the instrument status.

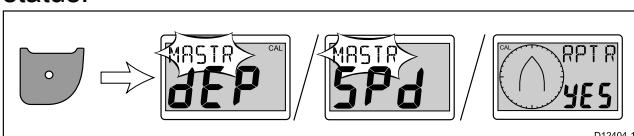

**Note:** The i40 Bidata requires an extra Action button push to switch from depth instrument status and speed instrument status.

3. Use the **Up** and **Down** buttons to change the instrument status between Master and Repeater.
4. To save your settings and return to normal operation from any page, simultaneously press and hold the **Down** and **Action** buttons for 2 seconds.

# Chapter 15: Technical specification

## Chapter contents

- [15.1 Technical specification on page 78](#)
- [15.2 Operating ranges on page 79](#)

## 15.1 Technical specification

	<b>i40 Bidata</b>	<b>i40 Depth</b>	<b>i40 Speed</b>	<b>i40 Wind</b>
Nominal supply voltage	12 V dc	12 V dc	12 V dc	12 V dc
Operating voltage range	10 V dc to 16 V dc	10 V dc to 16 V dc	10 V dc to 16 V dc	10 V dc to 16 V dc
Current consumption (12V supply) typical	35 mA	30 mA	25 mA	25 mA
Current consumption (12V supply) maximum	100 mA	100 mA	100 mA	100 mA
Operating temperature	0°C to +70°C (32°F to 158°F)	0°C to +70°C (32°F to 158°F)	0°C to +70°C (32°F to 158°F)	0°C to +70°C (32°F to 158°F)
Storage temperature	-30°C to +70°C (-22°F to 158°F)	-30°C to +70°C (-22°F to 158°F)	-30°C to +70°C (-22°F to 158°F)	-30°C to +70°C (-22°F to 158°F)
Relative humidity	93%	93%	93%	93%
Water proofing	IPX6	IPX6	IPX6	IPX6
Connections	<ul style="list-style-type: none"> <li>• SeaTalk</li> <li>• Speed transducer connections</li> <li>• Depth transducer connections</li> </ul>	<ul style="list-style-type: none"> <li>• SeaTalk</li> <li>• Depth transducer connections</li> </ul>	<ul style="list-style-type: none"> <li>• SeaTalk</li> <li>• Speed transducer connections</li> </ul>	<ul style="list-style-type: none"> <li>• SeaTalk</li> <li>• Wind transducer connections</li> </ul>
Conformance	Europe 2004/108/EC	Europe 2004/108/EC	Europe 2004/108/EC	Europe 2004/108/EC

## 15.2 Operating ranges

i40 Bidata	i40 Depth	i40 Speed	i40 Wind
<ul style="list-style-type: none"> <li>• Speed: 0 to 99.9 knots</li> <li>• Log: 0 to 99999 nautical miles</li> <li>• Trip: 0 to 99 nautical miles</li> <li>• Temperature: -0°C to +40°C</li> <li>• Depth: 0 to 400 feet</li> <li>• Shallow depth alarm: 0 to 29 feet</li> <li>• Deep depth alarm: 30 to 400 feet</li> <li>• Shallow anchor alarm: 1 to 250 feet</li> <li>• Deep anchor alarm: 10 to 400 feet</li> </ul>	<ul style="list-style-type: none"> <li>• Depth: 0 to 400 feet</li> <li>• Shallow depth alarm: 0 to 29 feet</li> <li>• Deep depth alarm: 30 to 400 feet</li> <li>• Shallow anchor alarm: 1 to 250 feet</li> <li>• Deep anchor alarm: 10 to 400 feet</li> </ul>	<ul style="list-style-type: none"> <li>• Speed: 0 to 99.9 knots</li> <li>• Log: 0 to 99999 nautical miles</li> <li>• Trip: 0 to 99 nautical miles</li> <li>• Temperature: -0°C to +40°C</li> </ul>	<ul style="list-style-type: none"> <li>• Wind speed: 0 to 60 knots</li> <li>• High wind speed alarm: 5 to 50 knots</li> <li>• Wind angle: 180° port to 180° starboard</li> </ul>





# Chapter 16: Spares and accessories

## Chapter contents

- [16.1 Accessories on page 82](#)
- [16.2 Spares on page 82](#)
- [16.3 SeaTalk accessories on page 83](#)
- [16.4 SeaTalk power cables on page 83](#)
- [16.5 Converters on page 84](#)

## 16.1 Accessories

Description	Part number	Notes
Desktop mounting bracket	E25024	
SeaTalk interconnect kit	E25028	

## 16.2 Spares

The table below lists the spare parts available for i40 instrument displays

Description	Part number	Note
i40 front bezel	R70112	
i40 Sun cover	R70113	

## 16.3 SeaTalk accessories

SeaTalk cables and accessories for use with compatible products.

Description	Part No	Notes
3-way SeaTalk junction box	D244	
1 m (3.28 ft) SeaTalk extension cable	D284	
3 m (9.8 ft) SeaTalk extension cable	D285	
5 m (16.4 ft) SeaTalk extension cable	D286	
8 m (26.2 ft) SeaTalk extension cable	D287	
12 m (39.4 ft) SeaTalk extension cable	E25051	
20 m (65.6 ft) SeaTalk extension cable	D288	

## 16.4 SeaTalk power cables

Part number	Description
D229	SeaTalk power cable.

## 16.5 Converters

Part number	Description
E22158	SeaTalk to SeaTalk <sup>ng</sup> Converter



**Raymarine**<sup>®</sup>  
A FLIR COMPANY